



Imran Jahangir

He was born in 1970. He joined M.F.Elahi & Co (E.P) PVT LTD. in 1990 for few years. He was joined M.F.Elahi Medical Co with his father and now he is Managing Partner of the Company

Mobile / WhatsApp : 0092 333 8664664.
E-mail: export@mfelahi.com



Muhammad Zakriya Imran

He was born in 1997. He was joined M.F.Elahi Medical Co With his Father & Grandfather in 2015 and now he is Partner in the Company

Mobile / whatsapp: 0092-336-7322733.
E-mail: zakriamfe@gmail.com





**Contact Corrosion
caused due to preparation
on brass rack**



**Discolouration caused
due to impurities in
water vapour / steam**

**Fretting Corrosion
caused due to insufficient
treatment with
LUBRICATING oil**



**Encrustations due to non
removal of organic
residues because of
improper / insufficient cleaning**

11 - Conditions for Sterilisation

- Do not overload instruments trays with more than 10 Kgs.
- Do not mix old instruments with new instruments.
- Micro and delicate instruments should be placed in secure containers.

10 - Maintenance of Instruments

- Periodically lubricate hinged / ratcheted instruments and instruments with joints, lubricating oil. Inspect edges of cutting instruments and sharpen if required. Inspect instruments with carbide tips for wear and tear. replace tips if required. Always maintain correct organisation of instruments in terms of size / old or new / large bulky instruments / micro delicate instruments.

9 - Care of Instruments

- Ensure all instruments are clean.
- Check functionality of individual instruments.
- Separate instruments which are not functioning correctly / show signs of corrosion / wear & tear.

8 - Drying

- Instruments should be dried immediately after rinsing / washing.
- Use of air pistol is recommended where ever possible.
- Use lint free paper / cloth to wipe.



**Crevice Corrosion caused
destruction of natural pass
coating of steel due to
mechanical / chemical destruction**

12 - Sterilisation

- If all necessary steps prior to sterilisation have been followed - PROCEED.
- Use demineralised water if possible / Quality of water / steam is very important.
- Excessive silicates in water cause blackening of instruments.
- Excessive chlorides can set in corrosion in instruments (level of chlorides should be less than 120mg / l equiv to 200mg / l of nacl).
- Optimal loading of trays prevents formation of condensates.

RECOMMENDED PREVENTION OF CORROSION OF SURGICAL INSTRUMENTS

7 - Washing

- Periodically test water for its chloride / silicate and mineral content.
- Use of enzyme based detergents is recommended and instructions for dilutions as recommended by the supplier should be followed. If powdered products are being used - particles should be dissolved.
- Final rinsing should be done in demineralised water.



Breaking due to Stress Corrosion caused by chlorides



Spots resulting from Improper Pre - rinsing / washing

1 - Specifications for Buying

- Choice of material ! / Does it fit the requirements ?
- Certificate of quality from the manufacturer.
- Choice of surface finish.

2 - Storing of Instruments

- Avoid any corrosive fumes / chemicals in storage area.
- Avoid area of high moisture to store instruments
- Brand new instruments should be cleaned / protective caps removed
- Appropriate RACKS/CONTAINERS should be used to store instruments.

Deposition due to caustic solution containing chlorides



PREVENTION FOR CORROSION OF INSTRUMENTS

3 - Usage

- Clean the instruments after every use.
- Avoid prolonged exposure to saline.
- Sterilise USED and UNUSED instruments.

4 - Preparation for disinfection & Cleaning

- Check the correctness of the delivery.
- Returning of instruments from OT:-
Dry instruments should be returned in dry condition
Returning instruments in wet condition:-
Instruments should be immersed in non corrosive combined disinfecting cum cleaning solutions.
- All hinges / ratches of instruments should be released. Breakpart instruments should be dismantled.



Effect of prolonged immersion in physiological saline

6 - Pre - Disinfection

- Use cold water only. Water over 45°C leads to coagulation of proteins and causes cleaning problems.
- Epidemic Hygiene Aspect - first cleaning followed by disinfection.
- Follow exposure times / dilution parameters / concentration levels as recommended by the manufacturer for optimal cleaning / disinfection, pH value of 4.5 to 9.5 is recommended for cleaning and disinfection solutions.
- Ultrasonic cleaners may be used in case of stubborn stains / encrustations.

5 - Re using Instruments

- Dismantle and immediately immerse USED and SOLID instruments, completely in a pre-disinfection bath.
- Use containers which are hermetically sealed during the process of thermal disinfection and cleaning. It is done at 93°C for approx 10 min. For heat sensitive material chemo thermal disinfection is done at 60°C for approx 10 min.
- Open the containers at 60°C or lower



Pitting due to Chlorides



Encrustation of blood due to improper washing / rinsing

OUR STORY

Running a successful business since 1908

M.F.ELAHI Medical Co., Ltd. was Re-established in 2001 in Sialkot, Punjab, an economically developed city.

We specialize in the development and production of reusable surgical and veterinary instruments supplies. With continuous efforts over the past 20 years, we have become a renowned pakistani enterprise in the field medical instrument supplies, Upholding the idea of promoting medical care, we have been making great efforts to continuously provide high-tech, safe, and effective medical products in the industry based on our own strengths and innovations. As a frontrunner in pakistani medical instruments and veterinary supplies industry, we offer more than 3000 types of products which cover surgery for all human body and the possible type of surgeries.

Agreement

M.FELAHI believes in the highest moral values and business ethics. Once a contract is made with a customer, we strictly follow up it in its true spirit.

QUALITY MANAGEMENT SYSTEM

Our manufacturing emphasizes on quality above all else. Our quality control team starts by ensuring the best available stainless steel making sure that it is properly forged and processed through a highly effective quality control.

WORLD WIDE DELIVERY

We Provide different delivery methods as per customer requirements

By Sea - By Air - By Courier - Ship - Plane - DHL/ Fedex etc.

Add pics here in printing We look forward to serve humanity!



PROFILE

About Us

M.F.Elahi Medical Co is one of the most professional medical company who focuses on improving the quality of life since 2002-2003 We are Manufacturer and Exporter of Surgical Instruments. We provide services to all Distributors, Wholesales, Retailers, Health Care institution & Clinical Laboratories etc.

Customer Service

M.F.Elahi Medical Co is dedicated to excellent customer service by providing the fastest delivery time in the industry. The majority of standard orders are shipped within 1-3 weeks.

Manufacturing Excellence

You are in Safe Hands, because this is our Forefathers Business since 1908.

International Presence

Our Products are used by Customers Worldwide from more than a Century.

Brand Services

We provide products with our own Brand Name M.F.E
We are also offering Private-Label Products or Services to our Clients.

Table of Contents



M.F. ELAHI MEDICAL CO
SERVING WORLDWIDE SURGICAL INSTRUMENTS



























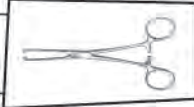
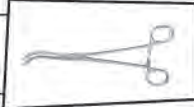

01	Scalpel Handles		01-to-04
02	Diagnostic		05-to-06
03	Anesthesia		07-to-09
04	Scissors		10-to-17
05	Dissecting and Tissue Forceps		18-to-22
06	Artery Forceps		23-to-36
07	Cotton Swap Forceps		37-to-38
08	Probes		39-to-40
09	Bone Surgery		41-to-61
10	Plaster Instruments		62-to-63
11	Suture		64-to-72
12	Neurosurgery		73-to-82
13	Cardiovascular		83-to-110
14	Tonsil		111-to-117
15	Otology		118-to-129



Table of Contents



M.F. ELAHI MEDICAL CO
SERVING WORLDWIDE SURGICAL INSTRUMENTS

16	Rhinology		130-to-141
17	Oral instrument		142-to-157
18	Stomach, Intestines, Rectum		158-to-166
19	Kidney, Liver, Gall Stone, Urology		167-to-173
20	Retractor		174-to-193
21	Dermatology		194-to-195
22	Tracheotomy		196-to-198
23	Ophthalmology		199-to-205
24	Gynecology		206-to-217
25	Obstetrics		218-to-221
26	Goitre		222
27	Sterilization		223
28	Asepsis		224
29	Holloware		225-to-229
30	TC Instrument		230-to-244



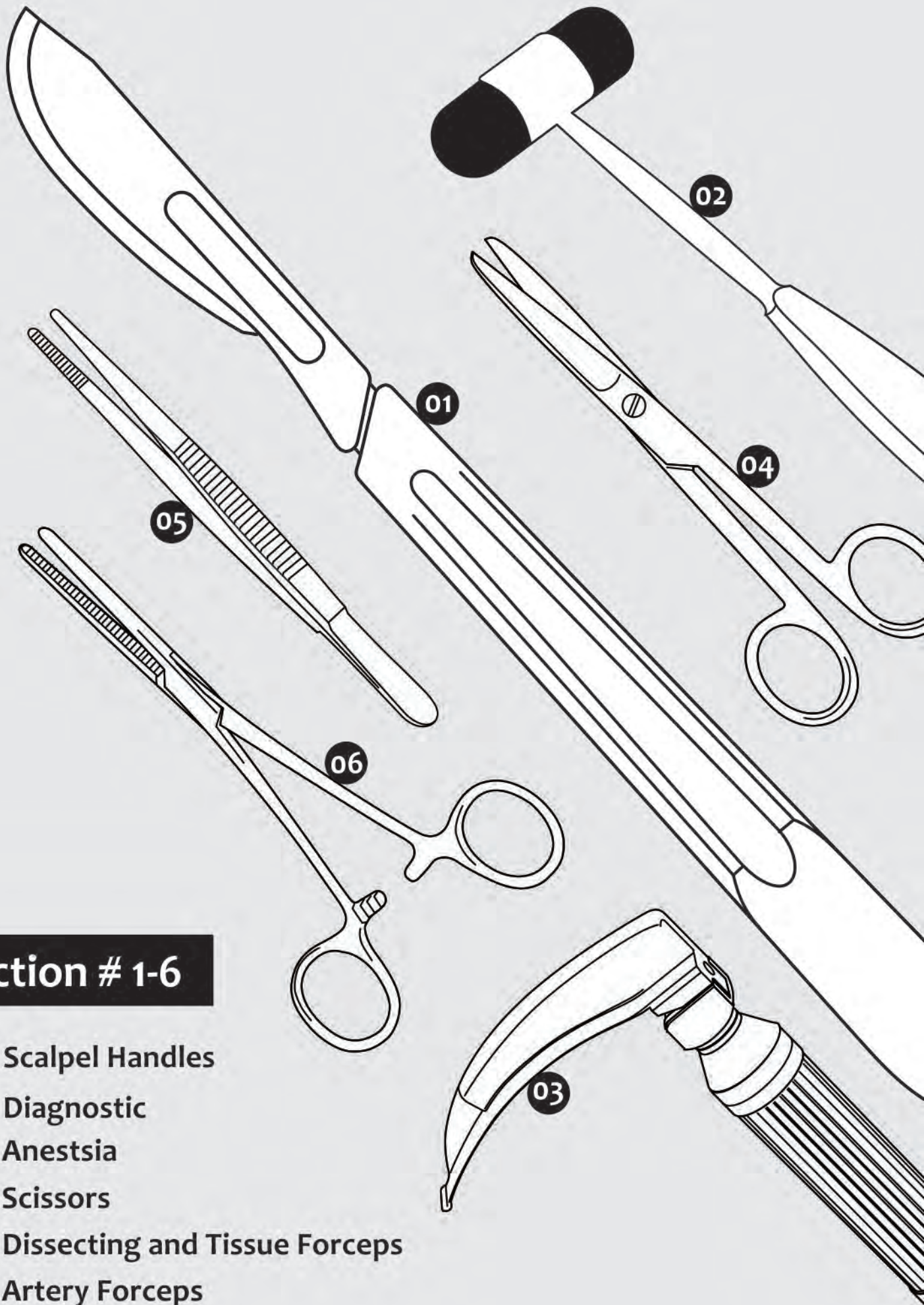

Section # 1-6

- 01 Scalpel Handles
- 02 Diagnostic
- 03 Anesthesia
- 04 Scissors
- 05 Dissecting and Tissue Forceps
- 06 Artery Forceps



Dissecting Knives

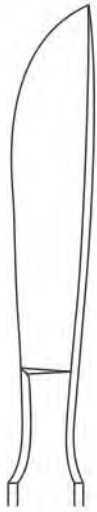

01-101 - Fig. 1 - 3.0cm
01-102 - Fig. 2 - 3.6cm
01-103 - Fig. 3 - 4.0cm
01-104 - Fig. 4 - 4.5cm
01-105 - Fig. 5 - 5.0cm



01-111 - Fig. 1
01-112 - Fig. 2
01-113 - Fig. 3
01-114 - Fig. 4
01-115 - Fig. 5
01-116 - Fig. 6
01-117 - Fig. 7
01-118 - Fig. 8
01-119 - Fig. 9



01-129 - Fig. 1
01-130 - Fig. 2
01-131 - Fig. 3
01-132 - Fig. 4
01-133 - Fig. 5



**Dieffenbach
13cm**
01-139 - Fig. 1
01-140 - Fig. 2
01-141 - Fig. 3
01-142 - Fig. 4
01-143 - Fig. 5



**Dieffenbach
13cm**
01-144 - Fig. 1
01-145 - Fig. 2
01-146 - Fig. 3
01-147 - Fig. 4
01-148 - Fig. 5



01-101-110
Fig. 1-10



01-106 - Fig. 6 - 2.7cm
01-107 - Fig. 7 - 3.5cm
01-108 - Fig. 8 - 4.0cm
01-109 - Fig. 9 - 4.7cm
01-110 - Fig. 10 - 5.0cm



01-111 - 01-128
Size: 14cm - 17.5cm



01-120 - Fig. 11
01-121 - Fig. 12
01-122 - Fig. 13
01-123 - Fig. 14
01-124 - Fig. 15
01-125 - Fig. 16
01-126 - Fig. 17
01-127 - Fig. 18
01-128 - Fig. 19



01-129 - 01-138
DIEFFENBACH
Size: 17cm



01-134 - Fig. 6
01-135 - Fig. 7
01-136 - Fig. 8
01-137 - Fig. 9



01-149 - 01-150
JOSEPH
Size: 14.5cm
Double Edged
Nasal Knives, Pointed



01-149
Straight



01-138 - Fig. 16
Tenotome



01-150
Curved





Amputating Knives, Cartilage Knives and Autopsy Knives

Amputating Knives	Amputating Knives	Flap Knives	Amputating Knives	Raspatory Wooden handle	Wooden handle	Metal handle	Amputating Knives	Amputating Knives
01-151 - 154 Liston Size: 13cm	01-152 Catlin Size: 160 mm	01-156 Langenbeck Size: 120 mm	01-157 Collin Size: 13cm	01-158 Size: 55 mm	01-159 Size: 70 mm	01-160 Size: 80 mm	01-161 Langenbeck Size: 180 mm	01-162 Langenbeck Size: 180 mm

01-163 Size: 255 mm wooden handle.	01-164 Size: 210mm with wooden handle	01-165 - 01-167 WALB with wooden handle	01-165 26cm 110mm	01-166 29cm 140mm	01-167 31cm 170mm	01-168 26cm 160mm	01-169 33.5cm 200mm
						01-170 38cm 240mm	
					01-168 - 01-170 VIRCHOW with hollow handle		





Trigeminal & Tonsil Knives, Razor Blade Holders & Breakers Razors and Dermatomes





Scalpel Handles



01-186
STANDARD
No. 4
Solid



01-187
Double Handle
No. 4 + No. 3
Solid



01-188
No. 4 L
Straight
Solid



01-189
No. 4 L
Solid Angled



01-190
COLLIN
No. 8
Hollow



01-191
COLLIN
No. 9
Hollow



01-192
16 cm
1.5/2.0mm



01-193
No. 3, Straight
Solid, Round
Size:14.5cm



01-194
No. 3
Angled
Solid,
Round
Size:14cm



01-195
Swivelhead
15.5 cm



01-196
Scalpel
Plastic
Handle
No.4



01-197
STANDARD
No. 3
Solid
Size:12cm



01-198
No. 3
Solid
Size:12cm
solid handle
style as
No.4



01-199
No. 3
Solid
Size:12cm
cm-graduation



01-200
No. 3 L
Straight
Solid, long
Size:21.5cm



01-201
No. 3 L
Angled
Solid, long
Size:21cm



01-202
No. 5



01-203
No. 7
Solid
Size:16cm



01-204
No. 7 K
Solid, short
Size:12.5cm



01-205
No.3
Size:15.5cm
with round
hollow handle



01-206
BARRON "B.P."
type blades for use
with No's 10,11,12,
& 15 blade





Percussion Hammers



02-301
TAYLOR
Size: 18 cm

02-302
DEJERINE
Size: 20 cm

02-303
DEJERINE
with needle
Size: 21 cm

02-304
DEJERINE
with needle
Size: 210 mm

02-305
TROEMNER
Size: 24 cm

02-306
BERLINER
Size: 17 cm



02-307
BUCK
with needle
and brush
Size: 18 cm

02-308
BUCK (Telescopic)
with needle
and brush
Size: 18 cm

02-309
BABINSKY
Size: 23 cm

02-310
RABINER
with needle
and brush
Size: 23 cm

02-311
National Hospital
Size: 33 cm

02-312
Queen Square
Size: 26 cm





Calipers, Dynamometers, Flexometer and Stethoscopes



02-313
ALY
Size: 17 cm

02-314
WARTENBERG
Pinwheel For
Neurological
Examination
Size: 19 cm



02-315
Pinard
Size: 18 cm
(wooden)



02-316
Pinard
Size: 15 cm
(plastic)



02-317
Pinard
Size: 15 cm
(aluminum)



02-318
Duplex super
lightweight

Ø 47 mm



Ruler
02-319- 15 cm
02-320- 30 cm
02-321- 60 cm



Measuring Range up to 120mm
with Vernier in 1/10mm & 1/16"

02-322
VERNIER Universal
Caliper of Steel
Graduated in mm &
inches up to 180mm



02-323
CARROLL
Size: 145 mm
Finger Goniometer



02-324
TOWNLEY
Graduated in mm
& inches Size: 115 mm



02-326
COLLIN Druck
Pressure 72 kg
Size: 12.5 cm

02-325
MOLTGEN
Goniometer

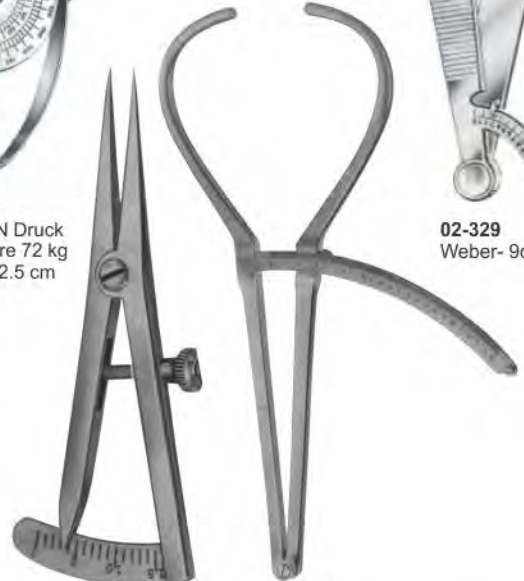

02-327
CASTROVIEJO
Caliper
Size: 7.5 cm



02-328
BERTILLON Caliper
For Measuring The Head
Size: 32 cm



02-329
Weber- 9cm





Diagnostic Sets



03-401
Ophthalmoscope



03-402
Otoscope



03-403
Medium battery
handle only,
25 mm diam.



Ear Specula
Dia 3.0mm, 4.0mm
5.0mm



03-404
Spare bulb
2.7 volt, for
otoscopes



03-405
Spare bulb
2.6 volt, for
ophthalmoscopes



03-406
Otoscope & Pouch



03-407
Infants
Size: 15 cm



03-408
Children
Size: 20 cm



03-409
Adults
Size: 25 cm



03-407 - 03-409
MAGILL
Catheter Introducing
Forceps



03-410
Ophthalmoscope set
in Case



03-411
Otoscope set in Case



03-412
Ophthalmoscope and
Otoscope set in Case



03-413
Complete ENT set
in Case





Laryngoscopes



1/3

03-414
MILLER
Laryngoscope Set, Consists Of Battery Handle (Without Battery)
With Five Miller Laryngoscope Blades, Fig 1 to 5

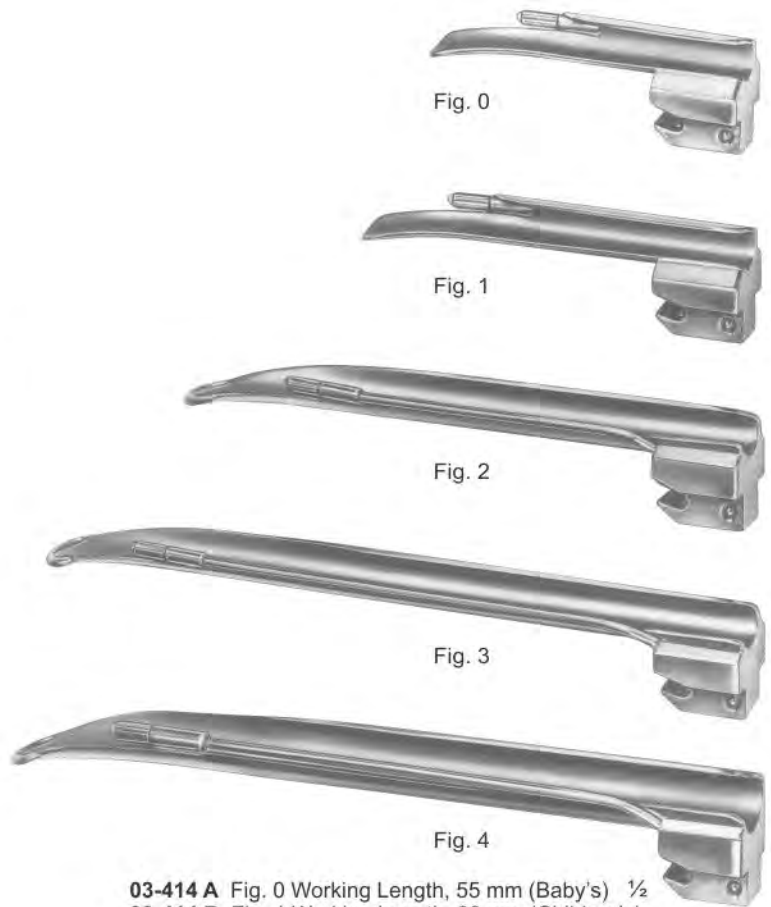

03-414 A Fig. 0 Working Length, 55 mm (Baby's) 1/2
03-414 B Fig. 1 Working Length, 80 mm (Children's)
03-414 C Fig. 2 Working Length, 130 mm (Adolescent's)
03-414 D Fig. 3 Working Length, 170 mm (Women's)
03-414 E Fig. 4 Working Length, 180 mm (Men's)



03-415
GUEDEL-NEGUS
Laryngoscope Set, Consists Of Battery Handle (Without Battery)
With Four Miller Laryngoscope Blades

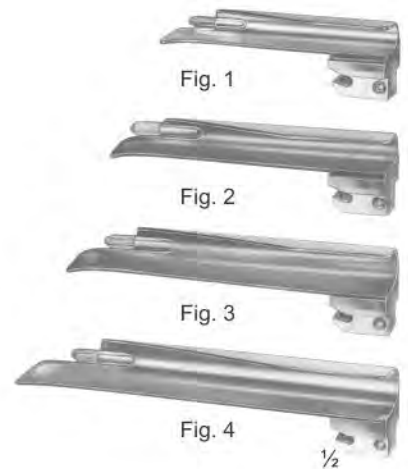

03-415 A Fig. 1 Working Length, 70 mm (Children's)
03-415 B Fig. 2 Working Length, 90 mm (Adolescent's)
03-415 C Fig. 3 Working Length, 110 mm (Women's)
03-415 D Fig. 4 Working Length, 135 mm (Men's)





Laryngoscopes



03-416
McINTOSH
Laryngoscope Set, Consists Of Battery Handle (Without Battery)
With Three McIntosh Blades, Fig. 1, Fig. 2, Fig. 3

03-417
McINTOSH
Laryngoscope Set, Consists Of Battery Handle (Without Battery)
With Five McIntosh Blades, Fig. 0, Fig. 1, Fig. 2, Fig. 3, Fig. 4



03-418
FOREGGER
Laryngoscope Set, Consists Of
Battery Handle (Without Battery)
With Three Foregger Blades,
Fig. 1, Fig. 2, Fig. 3.

03-419
FOREGGER
Laryngoscope Set, Consists Of
Battery Handle (Without Battery)
With Four Foregger Blades,
Fig. 1, Fig. 2, Fig. 3, Fig. 4.

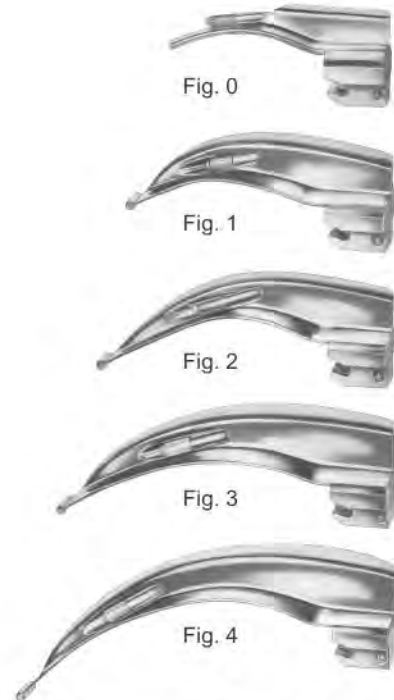

03-417 A Fig. 0 Working Length, 55 mm (Baby's)
03-417 B Fig. 1 Working Length, 75 mm (Children's)
03-417 C Fig. 2 Working Length, 90 mm (Adolescent's)
03-417 D Fig. 3 Working Length, 110 mm (Women's)
03-417 E Fig. 4 Working Length, 135 mm (Men's)

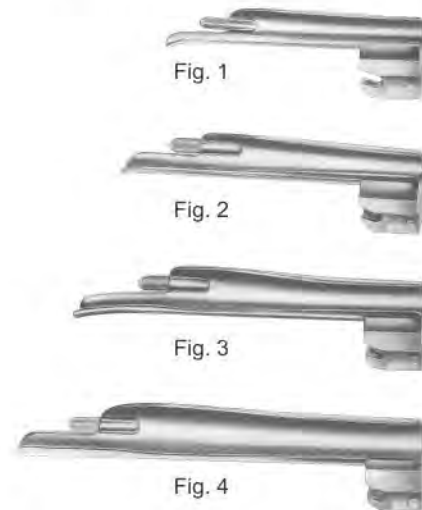

03-419 A Fig. 1 Working Length, 70 mm (Children's)
03-419 B Fig. 2 Working Length, 90 mm (Adolescent's)
03-419 C Fig. 3 Working Length, 110 mm (Women's)
03-419 D Fig. 4 Working Length, 135 mm (Men's)



03-420
Fiber Optic
Battery Handle
30mm diam.



03-421
Fiber Optic
Battery Handle
18mm diam.



03-422
Replacement Lamp
(Krypton) 2.5 V



03-423
Replacement Lamp
(Halogen) 2.5 V





Operating Scissors

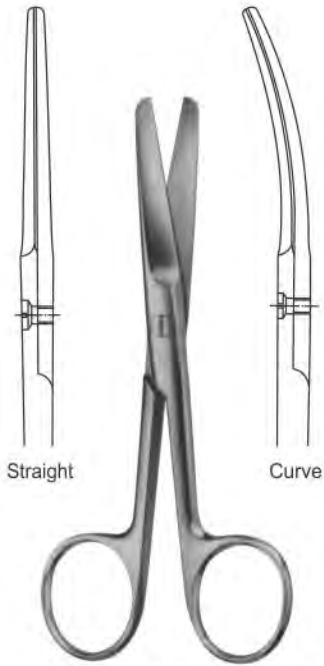

STANDARD (blunt/blunt)

- 04-501 (10.5 cm)
- 04-502 (11.5 cm)
- 04-503 (13.0 cm)
- 04-504 (14.5 cm)
- 04-505 (15.5 cm)
- 04-506 (16.5 cm)
- 04-507 (17.5 cm)
- 04-508 (18.5 cm)
- 04-509 (20.0 cm)

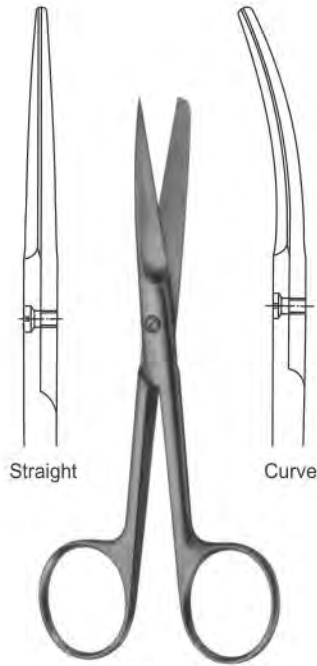

STANDARD (sharp/blunt)

- 04-510 (10.5 cm)
- 04-511 (11.5 cm)
- 04-512 (13.0 cm)
- 04-513 (14.5 cm)
- 04-514 (15.5 cm)
- 04-515 (16.5 cm)
- 04-516 (17.5 cm)
- 04-517 (18.5 cm)
- 04-518 (20.0 cm)

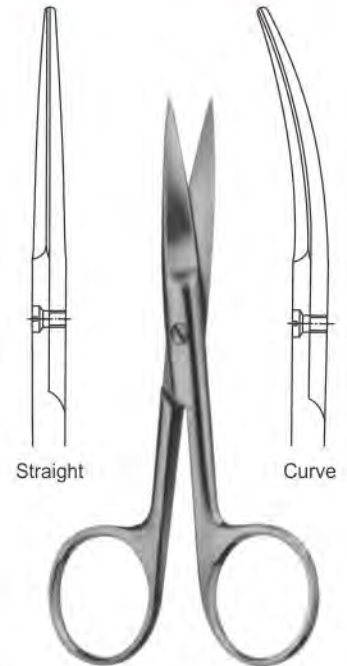

STANDARD (sharp/sharp)

- 04-519 (10.5 cm)
- 04-520 (11.5 cm)
- 04-521 (13.0 cm)
- 04-522 (14.5 cm)
- 04-523 (15.5 cm)
- 04-524 (16.5 cm)
- 04-525 (17.5 cm)
- 04-526 (18.5 cm)
- 04-527 (20.0 cm)



INCISION SCISSOR
04-528 - 14.5 cm



DEAVER
04-529 - 14 cm
04-530 - 14.5 cm

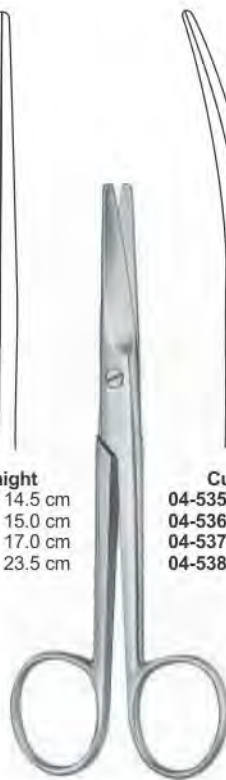

MAYO
04-535 - 04-538

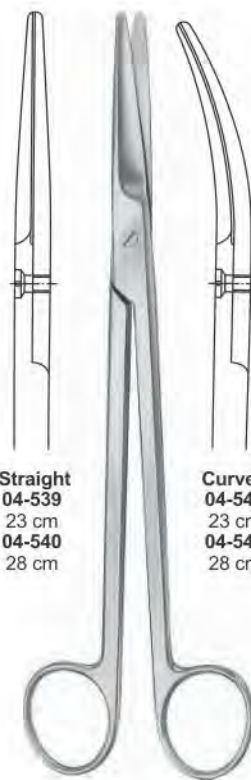

MAYO-HARRINGTON
04-539 - 04-542

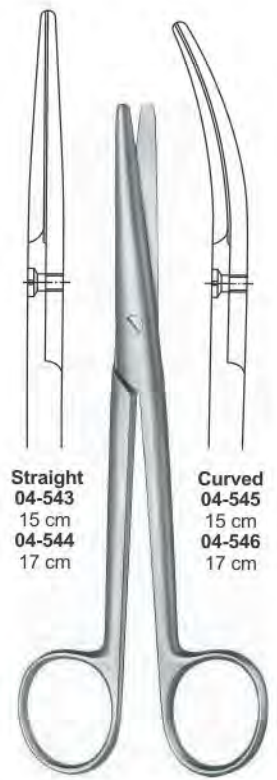

MAYO-STILLE
04-543 - 04-546

- Straight**
- 04-531 - 14.5 cm
 - 04-532 - 15.0 cm
 - 04-533 - 17.0 cm
 - 04-534 - 23.5 cm

- Curved**
- 04-535 - 14.5 cm
 - 04-536 - 15.0 cm
 - 04-537 - 17.0 cm
 - 04-538 - 23.5 cm

- Straight**
- 04-539 - 23 cm
 - 04-540 - 28 cm

- Curved**
- 04-541 - 23 cm
 - 04-542 - 28 cm

- Straight**
- 04-543 - 15 cm
 - 04-544 - 17 cm

- Curved**
- 04-545 - 15 cm
 - 04-546 - 17 cm





Operating Scissors



Mayo-Noble
04-547 - 16.5 cm

Sims
04-548 - 20 cm-Str
04-549 - 23 cm-Cvd

Kelly
04-550 - 16 cm-Str
04-551 - 16 cm-Cvd

Doyen
04-552 - 18.5 cm-Str
04-553 - 18.5 cm-Cvd

Sims-Siebold
04-554 - 24.5 cm-Str

Sims-Siebold
04-555 - 24.5 cm-Cvd



Straight
(blunt/blunt)
04-558-14.5 cm
(Sharp/blunt)
04-559-14.5 cm
(sharp/sharp)
04-560-14.5 cm

Curved
(blunt/blunt)
04-562-14.5 cm
(Sharp/blunt)
04-563-14.5 cm
(sharp/sharp)
04-564-14.5 cm

Straight
(blunt/blunt)
04-574-14.5 cm
(Sharp/blunt)
04-575-14.5 cm
(sharp/sharp)
04-576-14.5 cm

Curved
(blunt/blunt)
04-577-14.5 cm
(Sharp/blunt)
04-578-14.5 cm
(sharp/sharp)
04-579-14.5 cm

Metzenbaum Baby
04-556 - 11.5 cm-str
04-557 - 11.5 cm-cvd

Metzenbaum
04-561

Metzenbaum
04-565 - 15.5 cm-str
04-566 - 15.5 cm-cvd

Metzenbaum-Nelson (str/cvd)
04-567-18 cm 04-570-26 cm
04-568-20.5 cm 04-571-28.5 cm
04-569-23 cm 04-572-31 cm

Metzenbaum Fino
04-573 - 04-579

Metzenbaum-Fino
04-580-18 cm
04-581-20.5 cm
04-582-23 cm
slender pattern, S-shaped





Operating Scissors



Wertheim
04-583-20 cm
04-584-23 cm

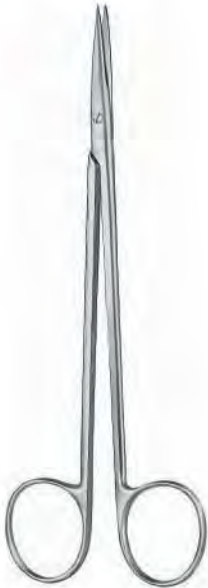

Nerve Dissecting Scissors
04-585-15.5 cm
str / cvd



Lexer
04-586-16 cm
04-587-16 cm
str / cvd



Lexer-Baby
04-588-10 cm
04-589-10 cm
str / cvd

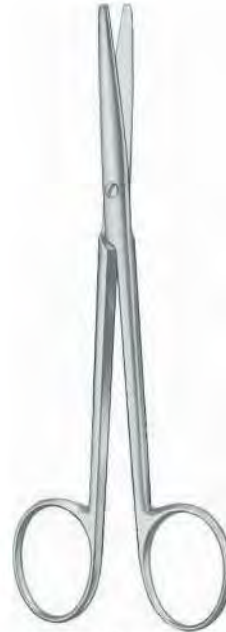

Lexer-Fino
04-590-16.5 cm
04-591-16.5 cm
str / cvd



Fomon
04-592-14 cm

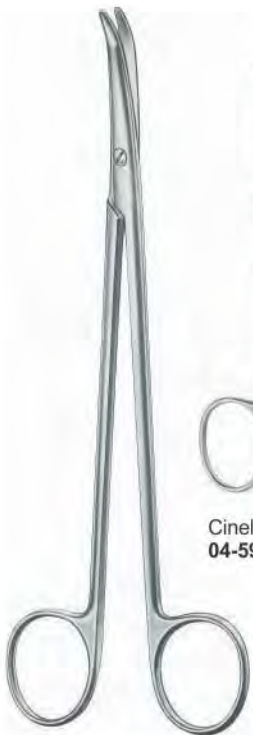

Thorek
04-593-14 cm



Cinelli
04-594-11.5 cm



Kilner
04-595-12 cm
04-596-15 cm

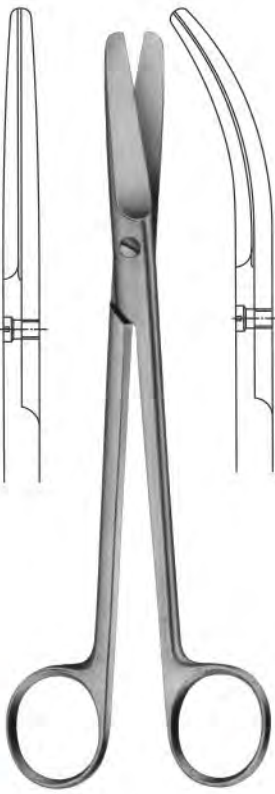

Crafoord
04-597-30 cm



Satinsky
04-598-30 cm



Potts-Smith
04-599 - 04-603
19 cm





Operating Scissors

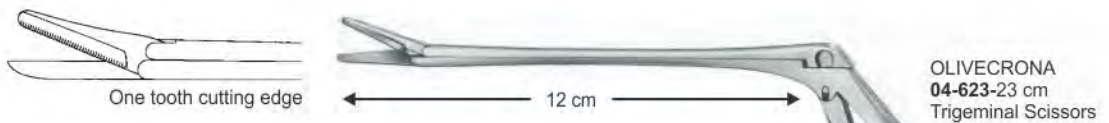
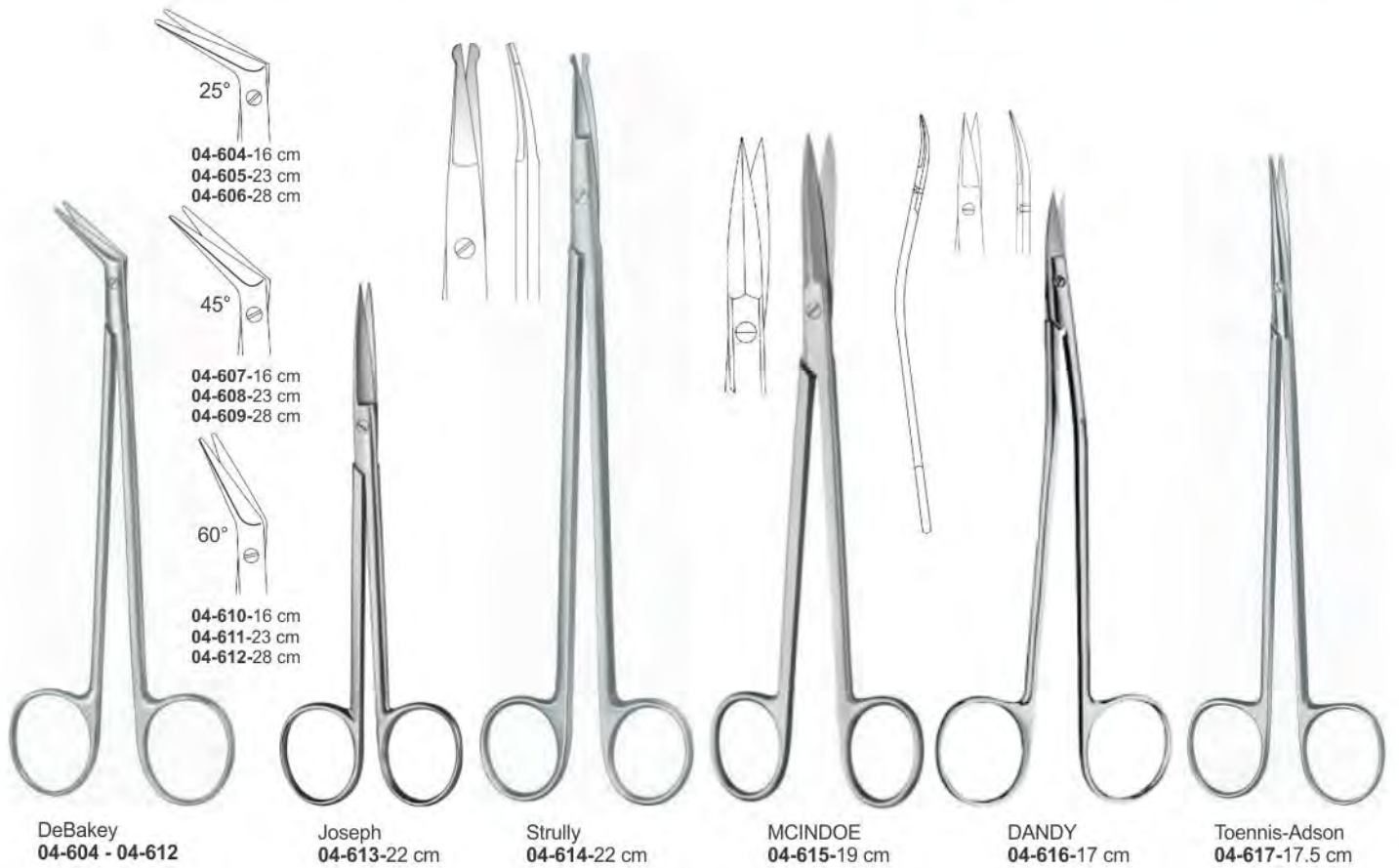

Operating Scissors



M.F. ELAHI MEDICAL CO
SERVING WORLDWIDE SURGICAL INSTRUMENTS

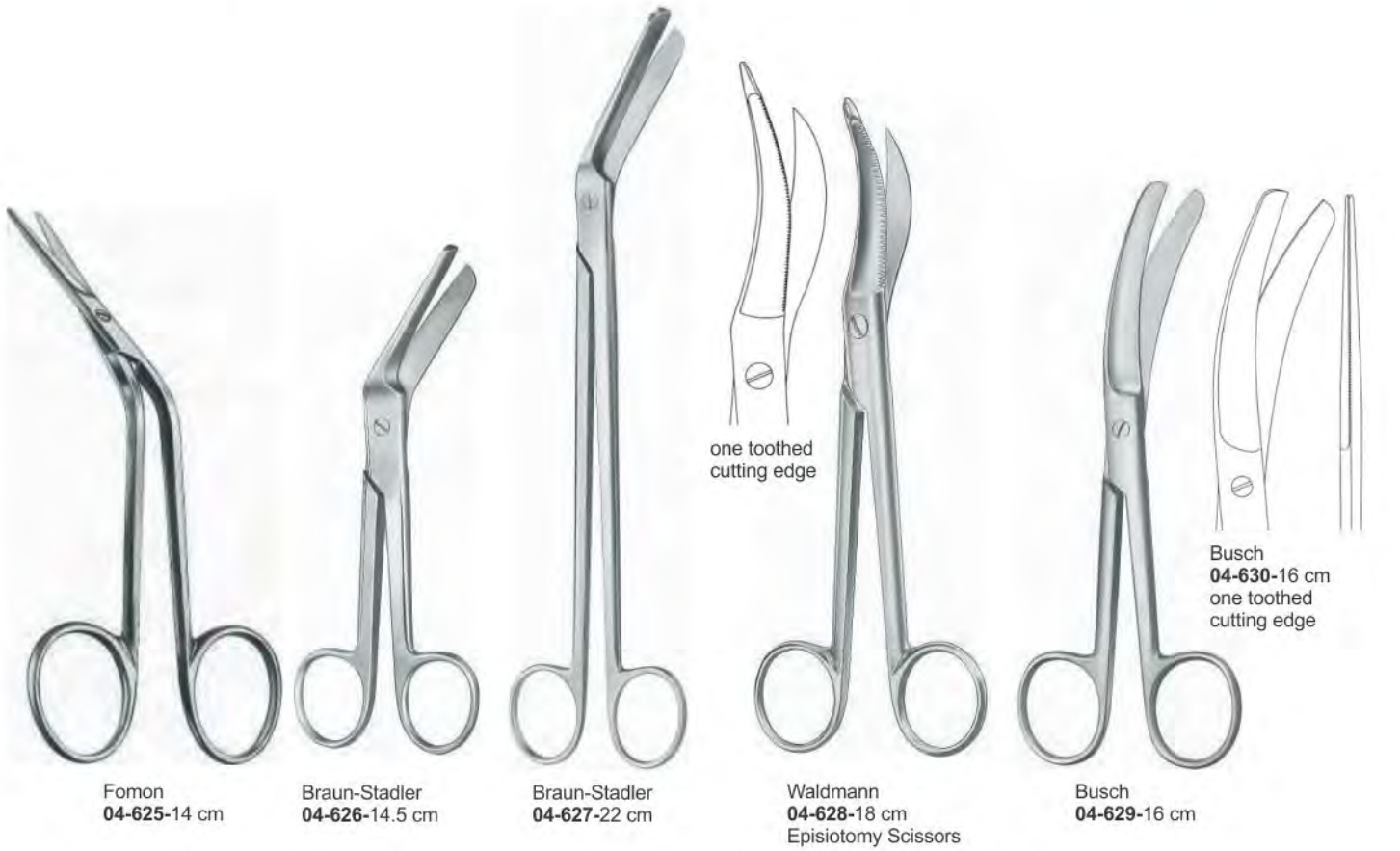



Operating Scissors



Eiselsberg
04-638-12 cm

Northbent
04-639-9 cm
04-640-12.5 cm

Nail Splinting Scissors
04-641-13 cm
04-642-15 cm

Kaye
04-643-18.5 cm
one toothed cutting edge

Aston
04-644-17 cm
one toothed cutting edge

Gorney
04-645-12.5 cm
04-646-19.5 cm
one toothed cutting edge



Kaye
04-647-11 cm

Salyer
04-648-9.5 cm

Salyer
04-649-10 cm

Iris Scissors (str/cvd)
04-650-9 cm
04-651-10.5 cm
04-652-11.5 cm

IRIS-FINE
04-653-11.5 cm

IRIS-FINE
04-654-11.5 cm
Angled





Operating Scissors





Operating Scissors



one toothed cutting edge

LaGrange
04-669-11.5 cm
S shape

Goldman-Fox
04-670-13 cm
str/cvd

Wagner
04-671-12 cm
str/cvd

Reynolds
04-672-15.5 cm-str
04-673-15.5 cm-cvd
04-674-18 cm-cvd

Jameson
04-675-15.5 cm

Good
04-676-19.5 cm



25°
04-678
19 cm

90°
04-681
17.5 cm

25°
04-683

60°
04-685

45°
04-679
18.5 cm

125°
04-682
17.5 cm

45°
04-684

90°
04-686

60°
04-680
17.5 cm

125°
04-687

Favaloro
04-677-14.5 cm





Diethrich
04-678 - 04-682







Mikro-Hegemann
04-683 - 04-687
18.5 cm





Dissecting Forceps & Tissue Forceps

 <p>05-701 - 05-709 Dissecting Forcep Standard Pattern</p>	 <p>05-710 - 05-718 Tissue Forcep Standard Pattern</p>	 <p>05-719 - 05-726 Dissecting Forcep Narrow Point</p>	 <p>05-727 - 05-734 Tissue Forcep Narrow Point</p>	 <p>05-735 - 05-742 USA Model Standard & Narrow Point</p>
<p>05-701 11.5 cm 05-702 13 cm 05-703 14.5 cm 05-704 16 cm</p>	<p>05-705 18 cm 05-706 20 cm 05-707 23 cm 05-708 25 cm 05-709 30.5 cm</p>	<p>05-710 11.5 cm 05-711 13 cm 05-712 14.5 cm 05-713 16 cm</p>	<p>05-714 18 cm 05-715 20 cm 05-716 23 cm 05-717 25 cm 05-718 30.5 cm</p>	<p>05-719 12 cm 05-720 13 cm 05-721 14.5 cm 05-722 16 cm</p>
			<p>05-723 20 cm 05-724 23 cm 05-725 25 cm 05-726 30 cm</p>	<p>05-727 12 cm 05-728 13 cm 05-729 14.5 cm 05-730 16 cm</p>
				<p>05-731 20 cm 05-732 23 cm 05-733 25 cm 05-734 30 cm</p>

 <p>05-743 Stille 15 cm</p>	 <p>05-744 Stille 15 cm</p>	 <p>05-746 Ochsner 14 cm</p>	 <p>Treves Turn over 05-747-12 cm 05-748-18 cm 05-749-25 cm</p>	 <p>Treves Block end 05-752-12 cm 05-753-18 cm 05-754-25 cm</p>	 <p>05-757 - 05-760 Potts-Smith</p>	 <p>05-761 - 05-764 Potts-Smith</p>
			<p>05-750-15 cm 05-751-20 cm</p>	<p>05-755-15 cm 05-756-20 cm</p>	<p>05-757 18 cm 05-758 21 cm 05-759 25 cm 05-760 30 cm</p>	<p>05-761 18 cm 05-762 21 cm 05-763 25 cm 05-764 30 cm</p>





Dissecting Forceps & Tissue Forceps

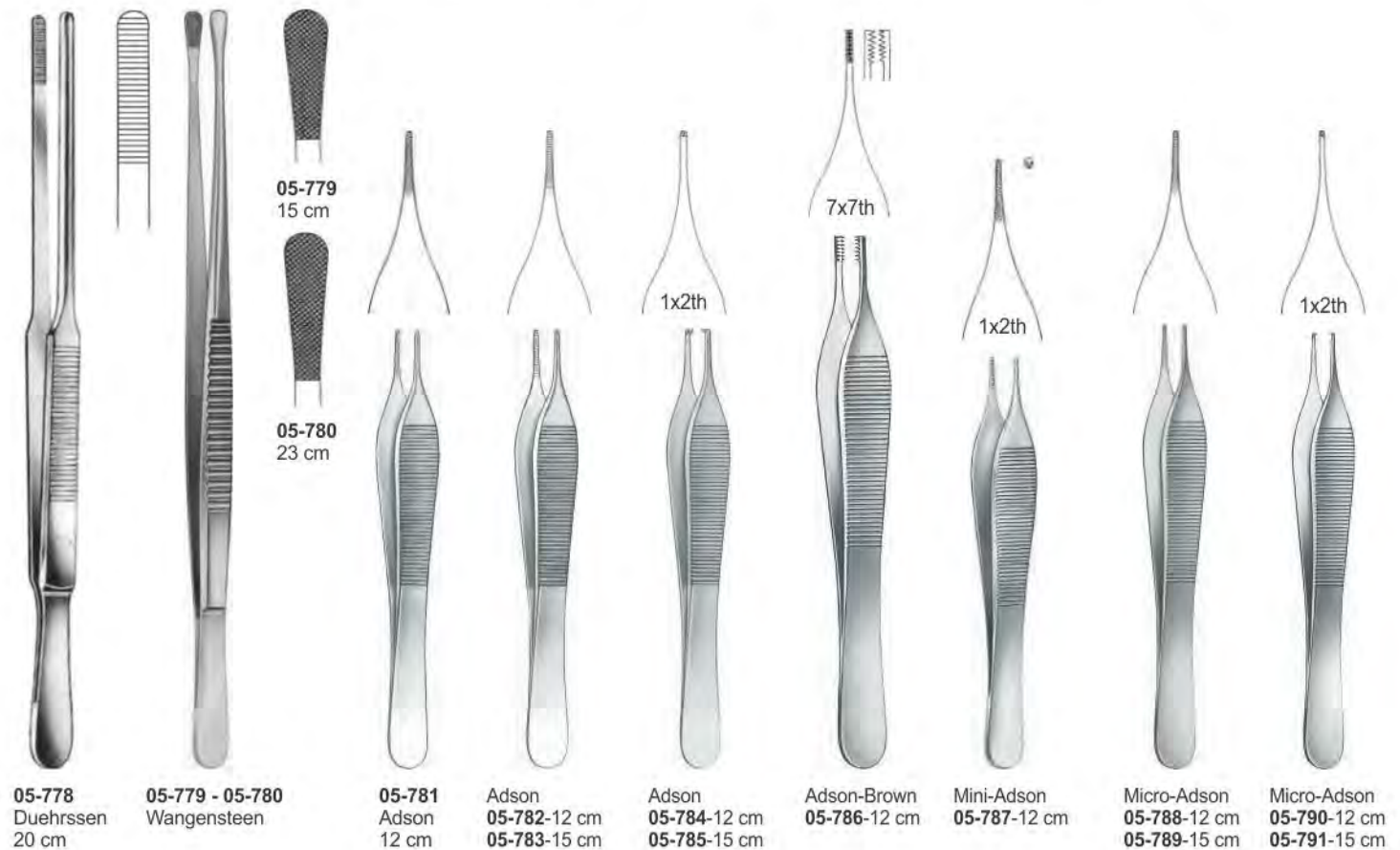
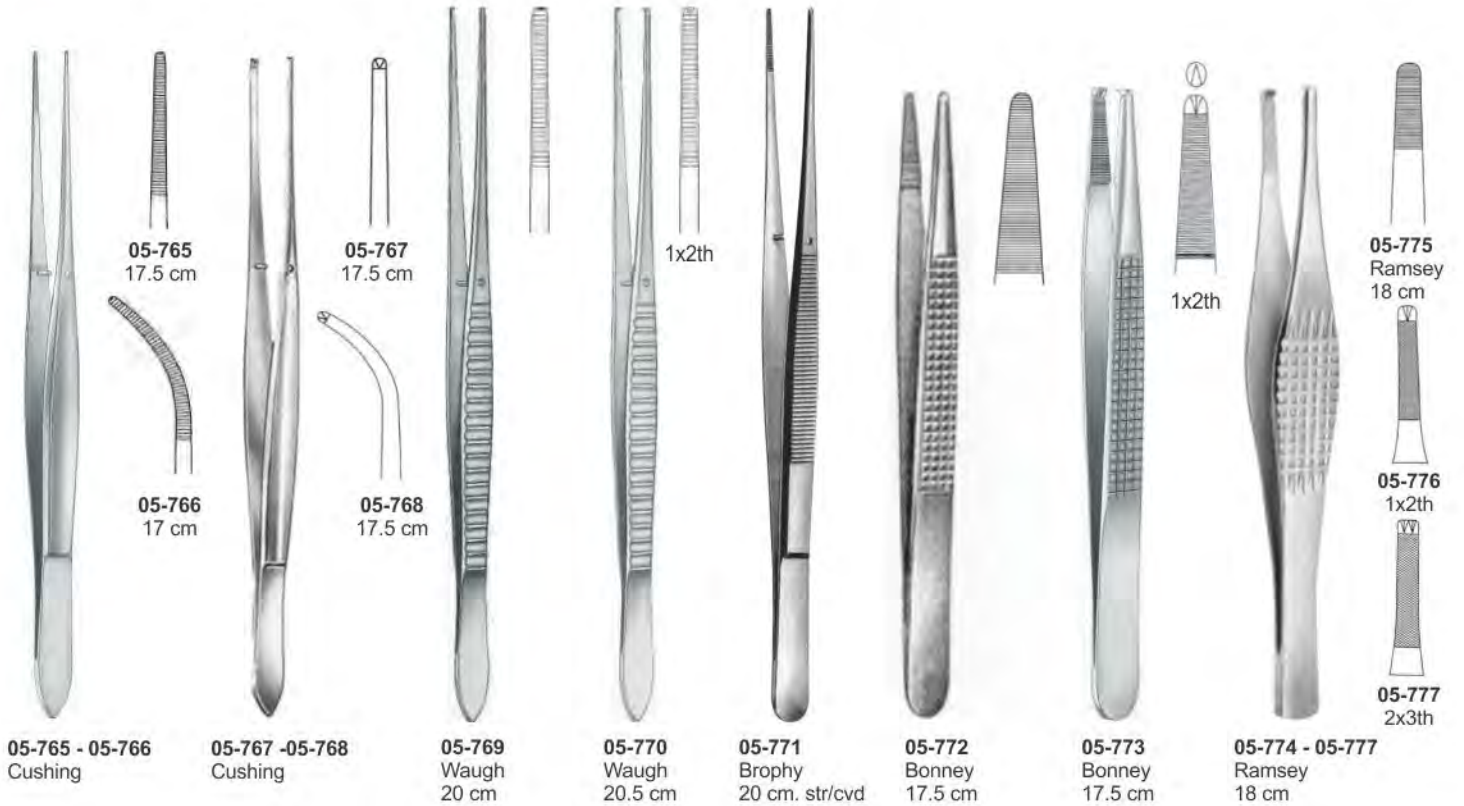



Dissecting Forceps & Tissue Forceps



05-792 McIndoe 15 cm	05-793 McIndoe 15 cm	Semken 05-794 -12.5 cm 05-795 -15 cm	Semken 05-796 -12.5 cm 05-797 -15 cm	Gerald 05-798 -17.5 cm 05-799 -17 cm	Gerald 05-800 -17.5 cm 05-801 -17 cm	Taylor 05-802 -17 cm	Taylor 05-803 -17.5 cm	Taylor 05-804 -17.5 cm
-----------------------------------	-----------------------------------	--	--	--	--	--------------------------------	----------------------------------	----------------------------------

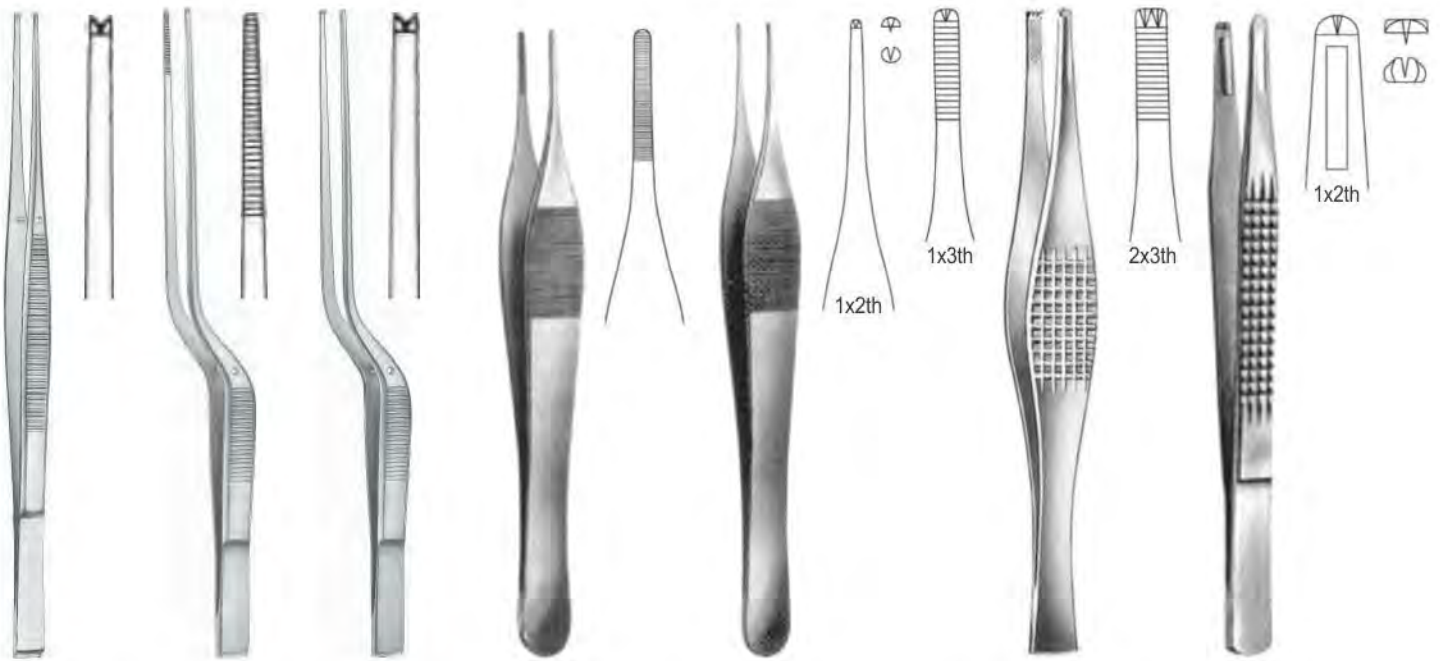

Taylor 05-805 -17 cm	Taylor 05-806 -18.5 cm	Taylor 05-807 -18.5 cm	Jefferson 05-808 -18 cm	Jefferson 05-809 -18 cm	Ferris Smith 05-810 -18 cm	Chamley 05-811 -18 cm
--------------------------------	----------------------------------	----------------------------------	-----------------------------------	-----------------------------------	--------------------------------------	---------------------------------





Dissecting Forceps & Tissue Forceps

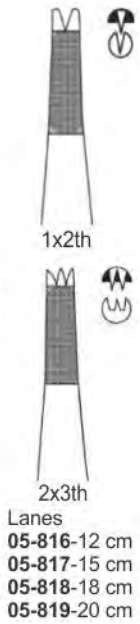

Lanes
05-812-12 cm
05-813-15 cm
05-814-18 cm
05-815-20 cm



Gillies
05-820-15.5 cm



Brown
05-821-15 cm
05-822-20 cm
05-823-25 cm



Graefe
05-824-10 cm



Stone
05-825-15 cm



Lerche
05-826-15 cm



Bickford
05-827-22.5 cm



Bickford
05-828-22.5 cm



Cairns (Dott)
05-829-21.5 cm
05-830-18 cm



05-831
Maingot Intestinal
Serrated - 2.8 cm



05-832
ST Mark
21.9 cm



05-833
EMMET
20 cm



05-834
Silcock
1x2 th / 10 cm



05-835
Canadian
2x3 th / 14 cm



05-836
Officer
4x5th / 15 cm



05-837
Mustarde
Combined, double
hooked jaw, 15 cm



05-838
Burrows
1x2th / 15 cm













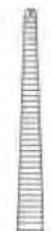

Lung Dissecting / Cilia / Splinter Forceps

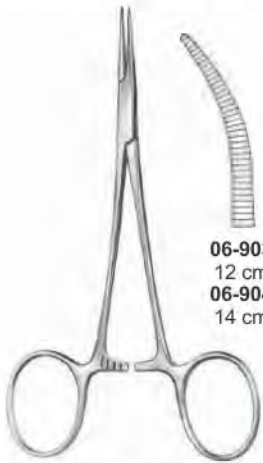
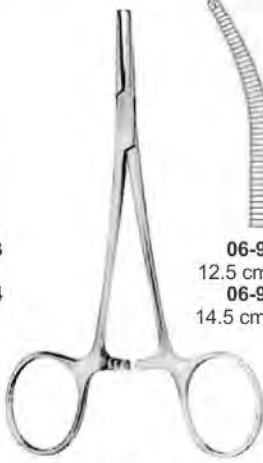
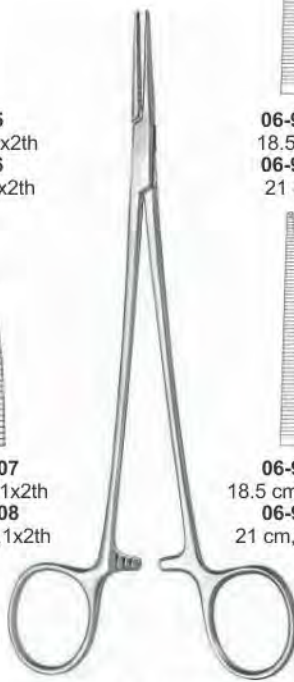
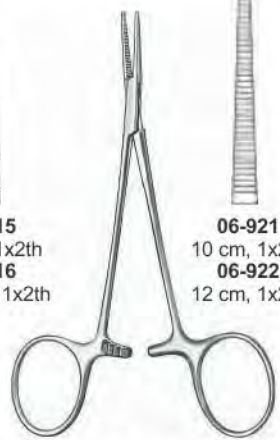
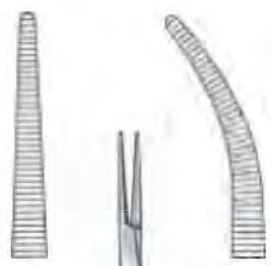

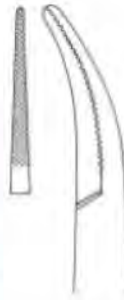

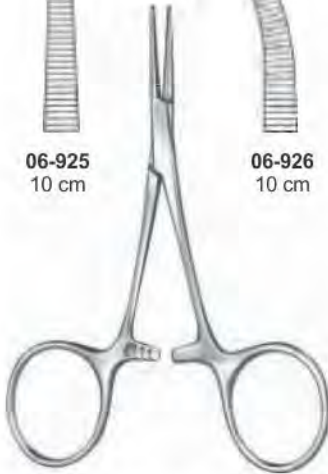
Haemostatic Forceps

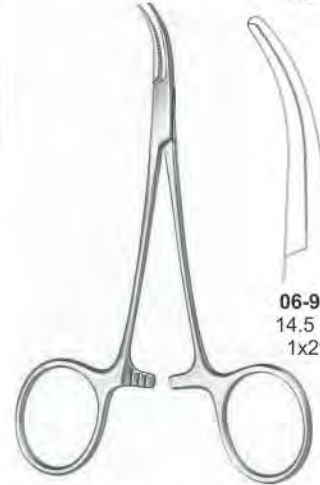
					
06-901 12.5 cm 06-902 14.5 cm	06-905 12.5 cm, 1x2th 06-906 14.5 cm, 1x2th	06-909 18.5 cm 06-910 21 cm	06-911 18 cm 06-912 20.5 cm	06-917 10 cm 06-918 12 cm	06-919 10 cm 06-920 12 cm
					
06-903 12 cm 06-904 14 cm	06-907 12.5 cm 1x2th 06-908 14.5 cm, 1x2th	06-913 18.5 cm, 1x2th 06-914 21 cm, 1x2th	06-915 18 cm, 1x2th 06-916 20.5 cm, 1x2th	06-921 10 cm, 1x2th 06-922 12 cm, 1x2th	06-923 10 cm, 1x2th 06-924 12 cm, 1x2th
06-901 - 06-904 Halsted-Mosquito	06-905 - 06-908 Halsted-Mosquito	06-909 - 06-916 Halsted-Mosquito	06-917 - 06-924 Micro-Mosquito		
					
06-925 10 cm	06-926 10 cm		06-930 14.5 cm	06-931 14.5 cm 1x2th	
					
06-925 - 06-926 Hartmann	06-927 Terrier, 8.5 cm 1x2th	06-928 Dandy-Mosquito 12 cm	06-929 Dandy 14.5 cm		





Haemostatic Forceps

				
06-932 14 cm	06-934 15.5 cm	06-935 15 cm	06-938 14.5 cm	06-940 16 cm
				
06-933 14 cm	06-936 15.5 cm 1x2th	06-937 15 cm 1x2th	06-939 14.5 cm	06-941 16 cm
				
06-932 - 06-933 Providence-Hospital	06-934 - 06-937 Leriche	06-938 - 06-939 Kelly	06-940 - 06-941 Kelly-Rankin	
				
06-943 Dunhill Striaight 12.5 cm	06-944 16 cm	06-946 16 cm	06-948 13 cm	06-952 13 cm
			06-949 15.5 cm	06-953 15.5 cm
06-942 Dunhill Striaight 12.5 cm	06-945 16 cm	06-947 16 cm 1X2th	06-950 18.5 cm	06-954 18.5 cm
				
06-942 Dunhill Striaight 12.5 cm	06-944 - 06-945 Crile-Rankin	06-946 - 06-947 Lovelace	06-948 - 06-955 Spencer-Wells	06-951 20 cm





Haemostatic Forceps

<p>06-956 14.5 cm 06-957 16 cm</p>	<p>06-958 13.5 cm 06-959 14.5 cm 06-960 17 cm</p>	<p>06-961 13 cm 06-962 14 cm 06-963 16.5 cm</p>	<p>06-964 06-968 14.5 cm 22.5 cm 06-965 06-969 16.5 cm 24.5 cm 06-966 06-970 18.5 cm 26 cm 06-967 06-971 20.5 cm 28.5 cm 06-972 30.5 cm</p>	<p>06-973 06-977 14.5 cm 22.5 cm 06-974 06-978 16.5 cm 24.5 cm 06-975 06-979 18.5 cm 26 cm 06-976 06-980 20.5 cm 28.5 cm 06-981 30.5 cm</p>	<p>06-982 14 cm 06-983 16.5 cm 06-984 18.5 cm</p> <p>06-985 14 cm 06-986 16 cm 06-987 18 cm</p>		
<p>06-956 - 06-957 Pean</p>		<p>06-958 - 06-963 Pean, Delicate pattern</p>		<p>06-964 - 06-981 Pean (Rochester)</p>		<p>06-982 - 06-987 Pean-Fino</p>	
<p>06-988 13 cm 06-989 14 cm 06-990 16 cm 1x2th</p>	<p>06-991 13 cm 06-992 14 cm 06-993 16 cm 1x2th</p>	<p>06-994 06-998 14.5 cm 22.5 cm 06-995 06-999 16.5 cm 24.5 cm 06-996 06-1000 18.5 cm 26 cm 06-997 06-1001 20.5 cm 28.5 cm 06-1002 30.5 cm 1x2th</p>	<p>06-1003 06-1007 14.5 cm 22.5 cm 06-1004 06-1008 16.5 cm 24.5 cm 06-1005 06-1009 18.5 cm 26 cm 06-1006 06-1010 20.5 cm 28.5 cm 06-1011 30.5 cm 1x2th</p>	<p>06-1012 14.5 cm 06-1013 16.5 cm 06-1014 18.5 cm 1x2th</p>	<p>06-1015 14 cm 06-1016 16 cm 06-1017 18 cm 1x2th</p>	<p>06-1018 21.5 cm 06-1019 26 cm</p> <p>06-1020 21.5 cm 06-1021 26 cm</p> <p>06-1022 21.5 cm 06-1023 26 cm 1x2th</p> <p>06-1024 21.5 cm 06-1025 26 cm 1x2th</p>	
<p>06-988 - 06-993 Kocher</p>		<p>06-994 - 06-1011 Kocher (Ochsner)</p>		<p>06-1012 - 06-1017 Kocher-Fino</p>		<p>06-1018 - 06-1025 Bengolea</p>	





Atrauma





Haemostatic Forceps, Dissecting and Ligature Forceps

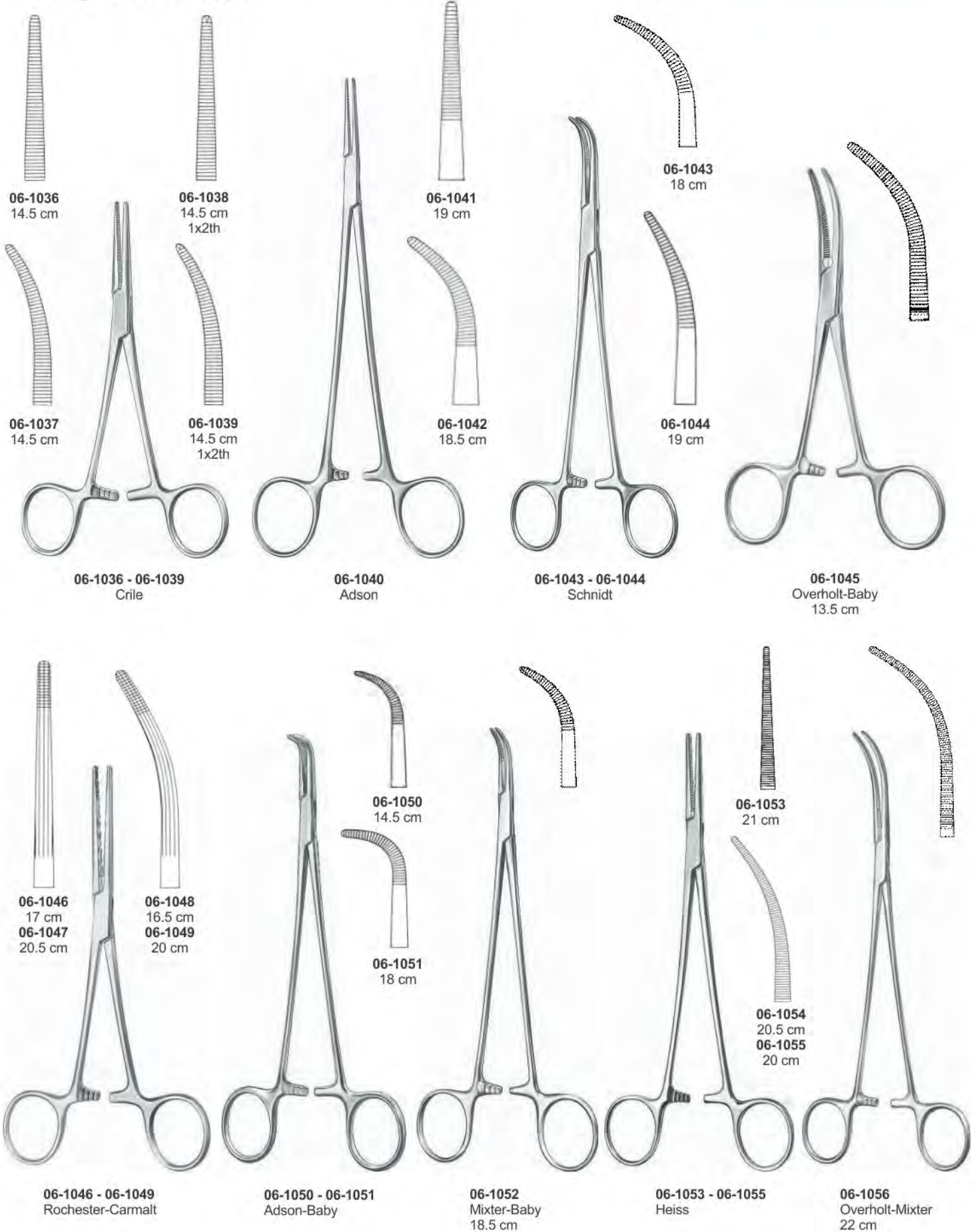



Dissecting and Ligature Forceps



06-1057 - 06-1058
Roberts

06-1059 - 06-1060
Sarot

06-1061 - 06-1062
Crafoord

06-1063
Crafoord-Sellors
Vascular clamp
24 cm

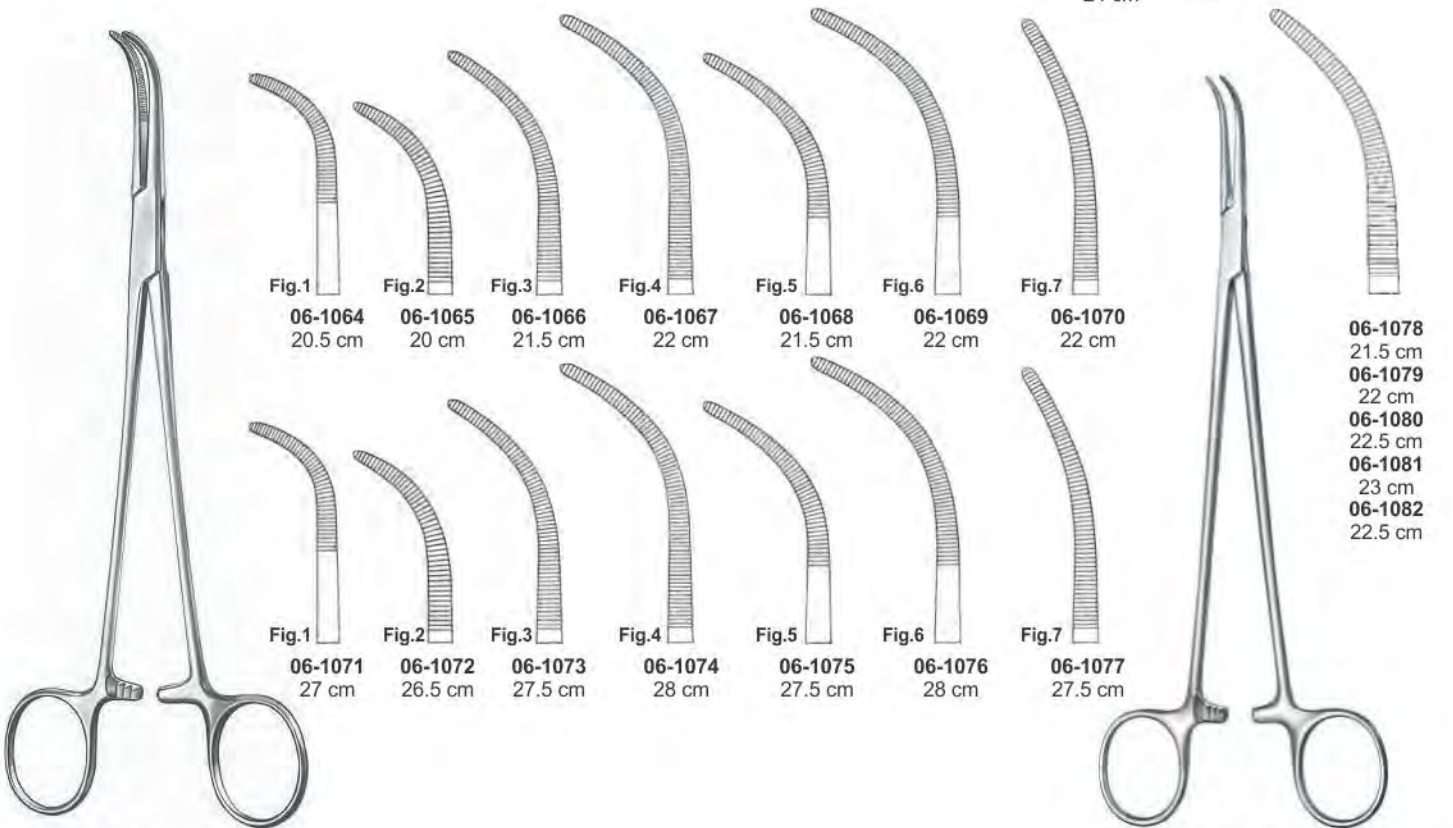

06-1064-06-1077
Overholt-Geissendörfer

06-1078 - 06-1082
Overholt-Fino

- | | | | | | | |
|------------------------------------|------------------------------------|------------------------------------|----------------------------------|------------------------------------|----------------------------------|------------------------------------|
| Fig.1
06-1064
20.5 cm | Fig.2
06-1065
20 cm | Fig.3
06-1066
21.5 cm | Fig.4
06-1067
22 cm | Fig.5
06-1068
21.5 cm | Fig.6
06-1069
22 cm | Fig.7
06-1070
22 cm |
| Fig.1
06-1071
27 cm | Fig.2
06-1072
26.5 cm | Fig.3
06-1073
27.5 cm | Fig.4
06-1074
28 cm | Fig.5
06-1075
27.5 cm | Fig.6
06-1076
28 cm | Fig.7
06-1077
27.5 cm |

- 06-1078**
21.5 cm
- 06-1079**
22 cm
- 06-1080**
22.5 cm
- 06-1081**
23 cm
- 06-1082**
22.5 cm



Bile Duct Clamps, Dissecting and Ligature Forceps



M.F. ELAHI MEDICAL CO
SERVING WORLDWIDE SURGICAL INSTRUMENTS



06-1083-13 cm
06-1084-16 cm
06-1085-18 cm
06-1086-21 cm
06-1087-23 cm
06-1088-25 cm
06-1089-28 cm

Gemini-Mini
06-1090-18 cm
06-1091-23 cm
06-1092-25 cm
06-1093-28.5 cm

06-1083-06-1093
Gemini



06-1094
28.5 cm
06-1095
29.5 cm

06-1094-06-1095
Zenker

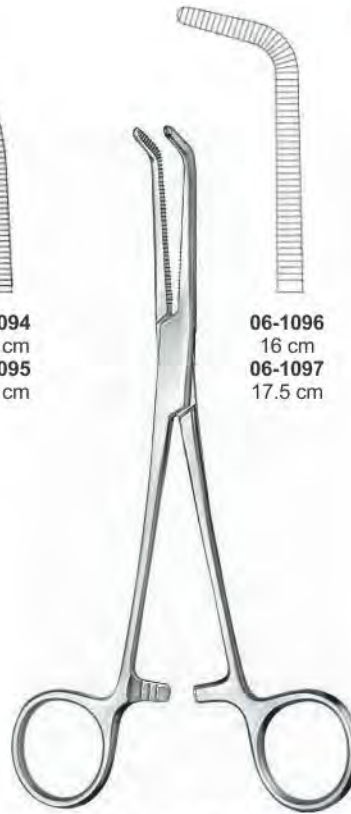

06-1096
16 cm
06-1097
17.5 cm

06-1096-06-1097
Mixer



06-1098
22.5 cm
06-1099
26 cm
06-1100
28 cm

06-1101-15 cm
06-1102-18 cm
06-1103-18.5 cm
06-1104-20 cm
06-1105-23 cm
06-1106-26 cm

06-1098-06-1106
Mixer O'Shaughnessy



06-1107
Lahey
23.5 cm



06-1108
19.5 cm
06-1109
22.5 cm

06-1108-06-1109
Lahey



06-1110
Finochietto
24.5 cm

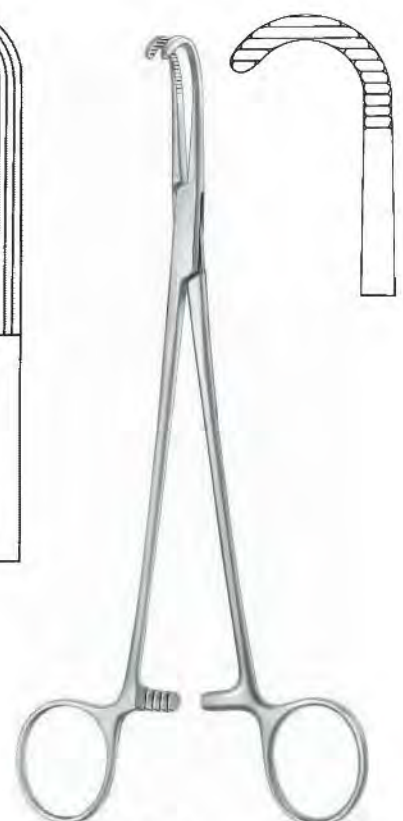

06-1111
Desjardins
21 cm



Dissecting and Ligature Forceps



06-1112
21 cm
06-1113
24.5 cm

06-1112-06-1113
Wikstroem



06-1114
McQuigg-Mixer
23.5 cm



06-1115-06-1123
Kelly

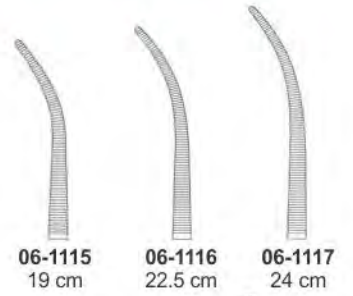

06-1115 19 cm
06-1116 22.5 cm
06-1117 24 cm

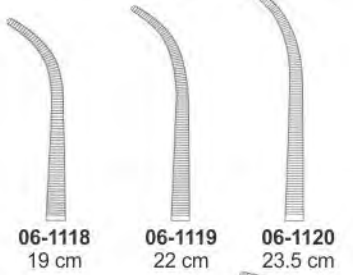

06-1118 19 cm
06-1119 22 cm
06-1120 23.5 cm

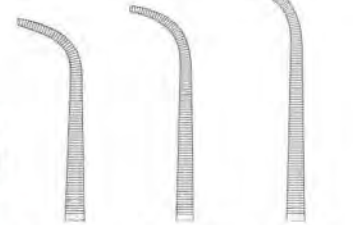

06-1121 18.5 cm
06-1122 21.5 cm
06-1123 23.5 cm



06-1124
Lawrence
28 cm



06-1125
Meeker
28 cm



06-1126-06-1127
Negus

Fig.1
06-1126
19.5 cm

Fig.2
06-1127
20 cm



06-1128
Johns-Hopkins
20 cm





Hysterectomy & Peritoneum Forceps

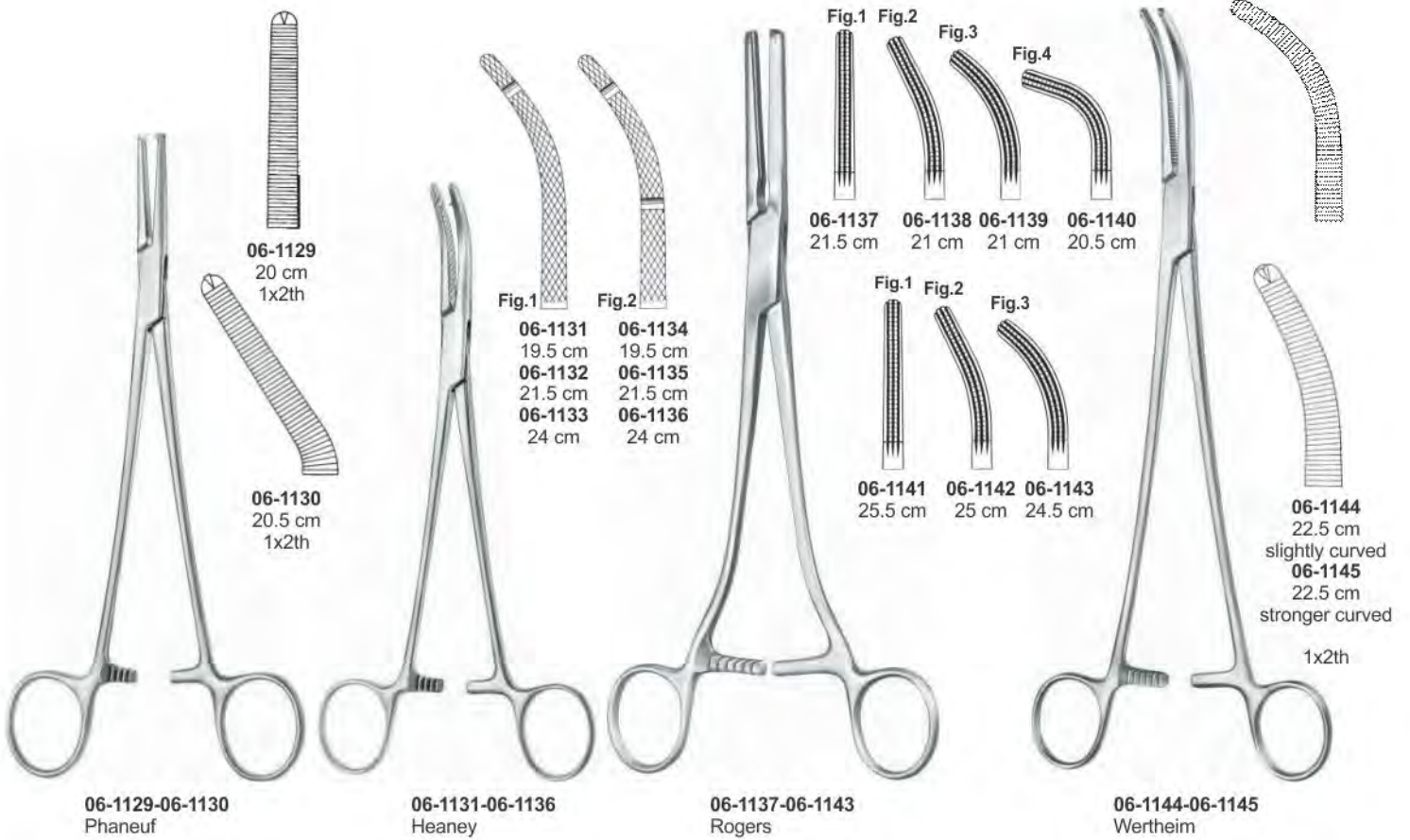



Tangential Forceps, Vaginal & Kidney Pedicle Clamps

Atrauma



06-1152-06-1153
Uro-Tangential

06-1152
Fig.1
25 cm

06-1153
Fig.2
26 cm

Atrauma



06-1154-06-1155
Guyon

06-1154
23 cm

06-1155
24 cm



06-1156
Wertheim-Cullen
21 cm



06-1157-06-1159
Guyon

06-1157
19.5 cm

06-1158
21.5 cm

06-1159
24.5 cm



06-1160
Guyon
24 cm



06-1161
Mayo-guyon
23 cm





Towel Clamps



06-1162
Schadel Sharp
9 cm



06-1163
ENGL. MODELL
9 cm



JONES
06-1164-5.5 cm
06-1165-8.5 cm
Sharp



06-1166
JONES Sharp
With Clip for Tubing
or Cable 8.5 cm



06-1167
DOYEN
11 cm



06-1168
DOYEN
18 cm

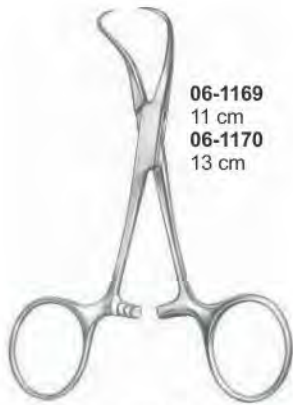

06-1169-06-1170
Backhaus
Delicate pattern
sharp



06-1171
Backhaus with Clip
for Tubing or Cable
11 cm



06-1172-06-1175
Backhaus
sharp



Backhaus Towel
8 cm with open ja
06-1172-8 cm
06-1173-11 cm
06-1174-13 cm
06-1175-15 cm

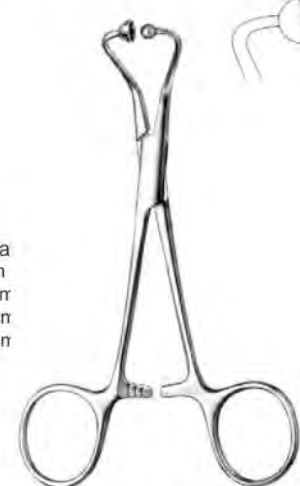

Ball & Socket
06-1176-11.5 cm
06-1177-14 cm



06-1178
Peers-Bertrammodif.
wide jaw for tube fixation
15 cm



06-1179
Peers-Bertram
14.5



Tohoku (Blunt)
06-1180-10.5 cm
06-1181-13.5 cm



06-1182
ROBIN-13.5 cm
with holder for
cable up to 5 mm



06-1183
ROBIN-13.5 cm
with holder for cable
up to 13 mm tubing





Towel Clamps & Tubing Clamps

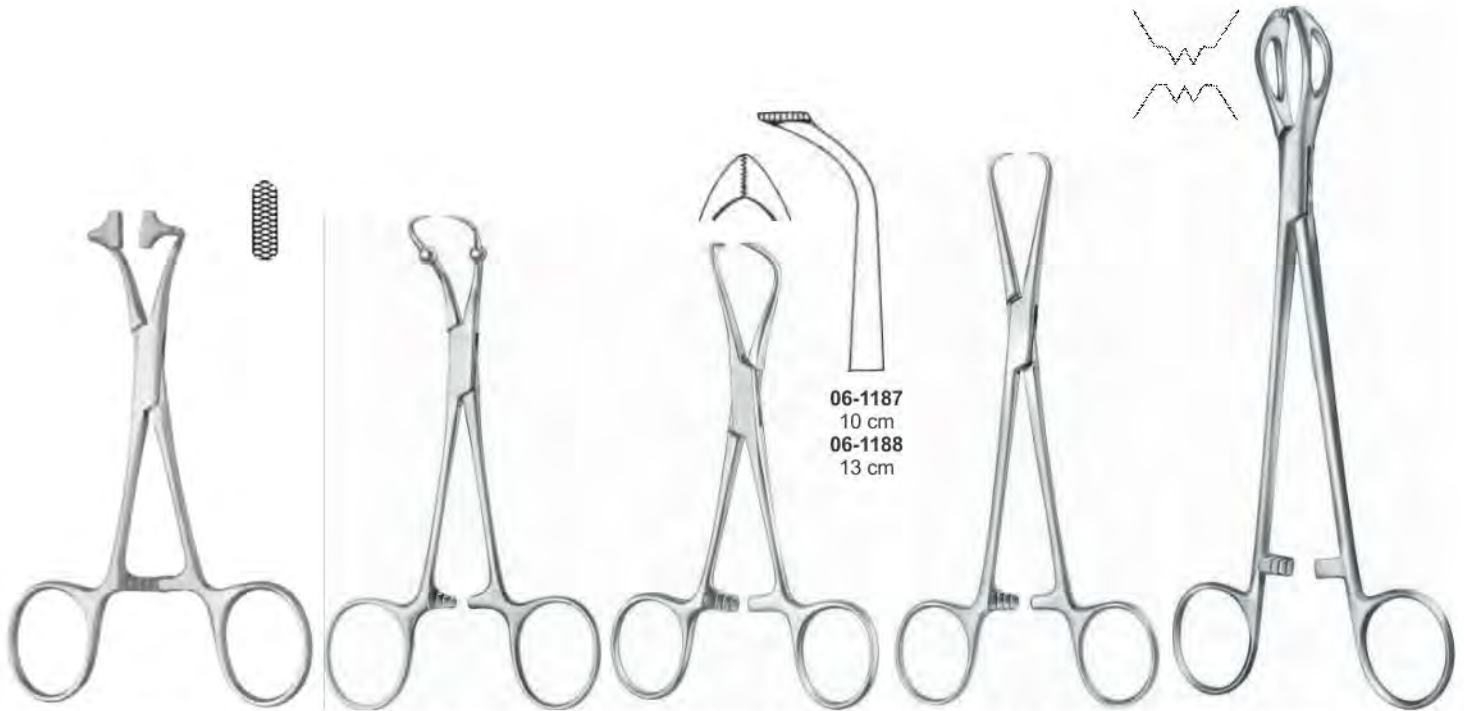

Paper Towel Forceps
06-1184-10 cm
06-1185-13 cm

06-1186
Roeder
13.5 cm

06-1187-06-1188
Lorna

06-1187
10 cm
06-1188
13 cm

06-1189
Bernhard Sharp
16.5 cm

06-1190
Lane
19.5 cm



06-1191
with extra long ratchet
14.5 cm

06-1192-06-1194
Schoenberg

06-1192 15.5 cm
06-1193 19 cm
06-1194 20 cm

06-1195-06-1197
Schoenberg
with safety guard

06-1195 15.5 cm
06-1196 19 cm
06-1197 20 cm

06-1198-06-1200
Presbyterian-hospital
smooth jaw

06-1198-15.5 cm
06-1199-19 cm
06-1200-20 cm



Reposition Forceps



M.F.ELAHI MEDICAL CO
SERVING WORLDWIDE SURGICAL INSTRUMENTS



Steinhäuser
06-1201
13,5 cm



Lewin
06-1202
18 cm



Haase
06-1203
16.5 cm



06-1204
Reposition forceps,
for small fragments
135 mm



06-1205
15 cm
lange Sperre
long ratchet

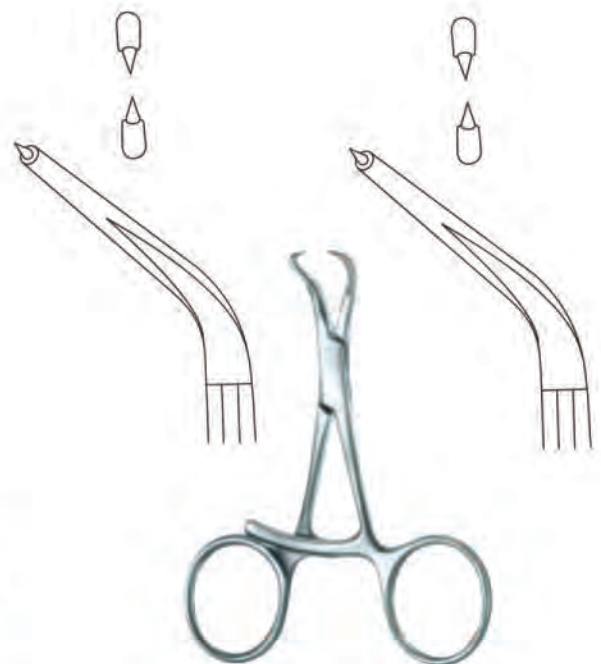

06-1206
9.5 cm
lange Sperre
long ratchet
cremallera



Reposition Forceps



M.F. ELAHI MEDICAL CO
SERVING WORLDWIDE SURGICAL INSTRUMENTS



06-1207
21 cm

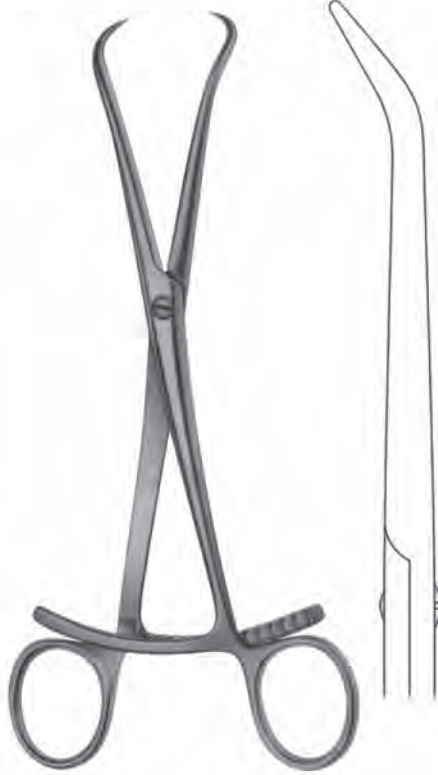

06-1208
Reposition forceps
205 mm

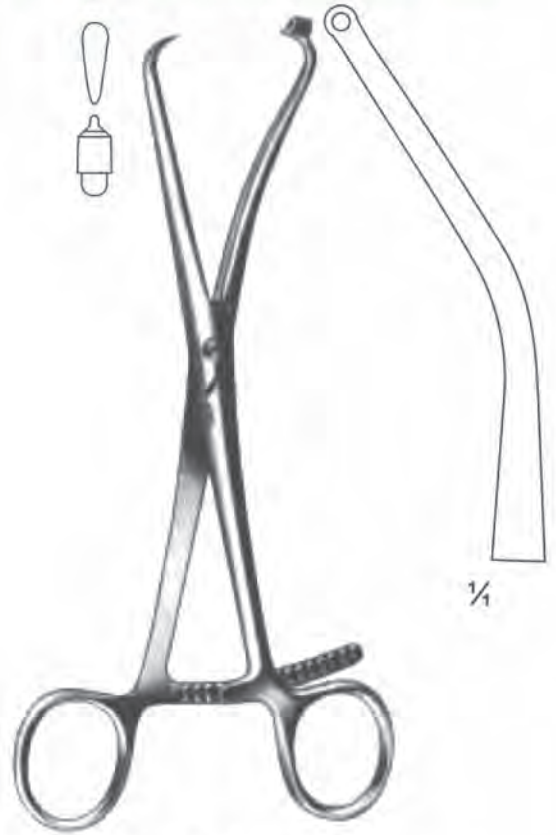

06-1209
Meyer
20 cm

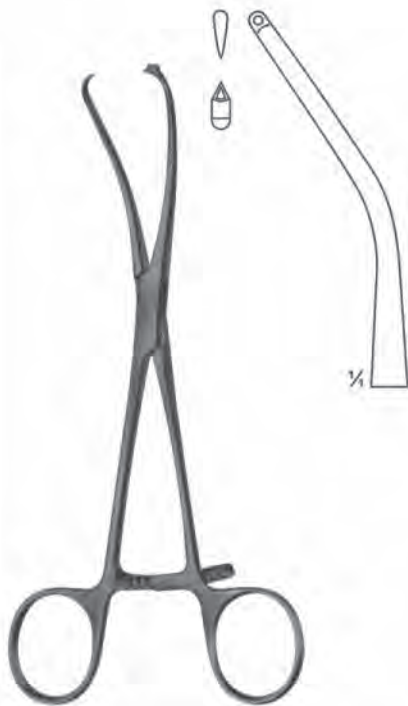

06-1210
MEYER
Reposition forceps
for fingers, with drill
guide for KIRSCHNER
wires up to daim. 1.0 mm
170 mm

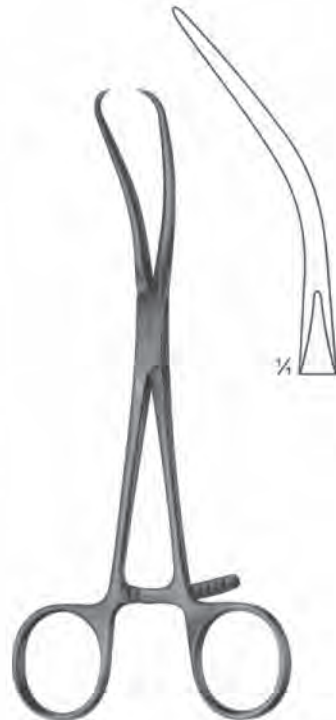

06-1211
REILL
Reposition forceps,
170 mm



06-1212
Reposition forceps,
14 cm



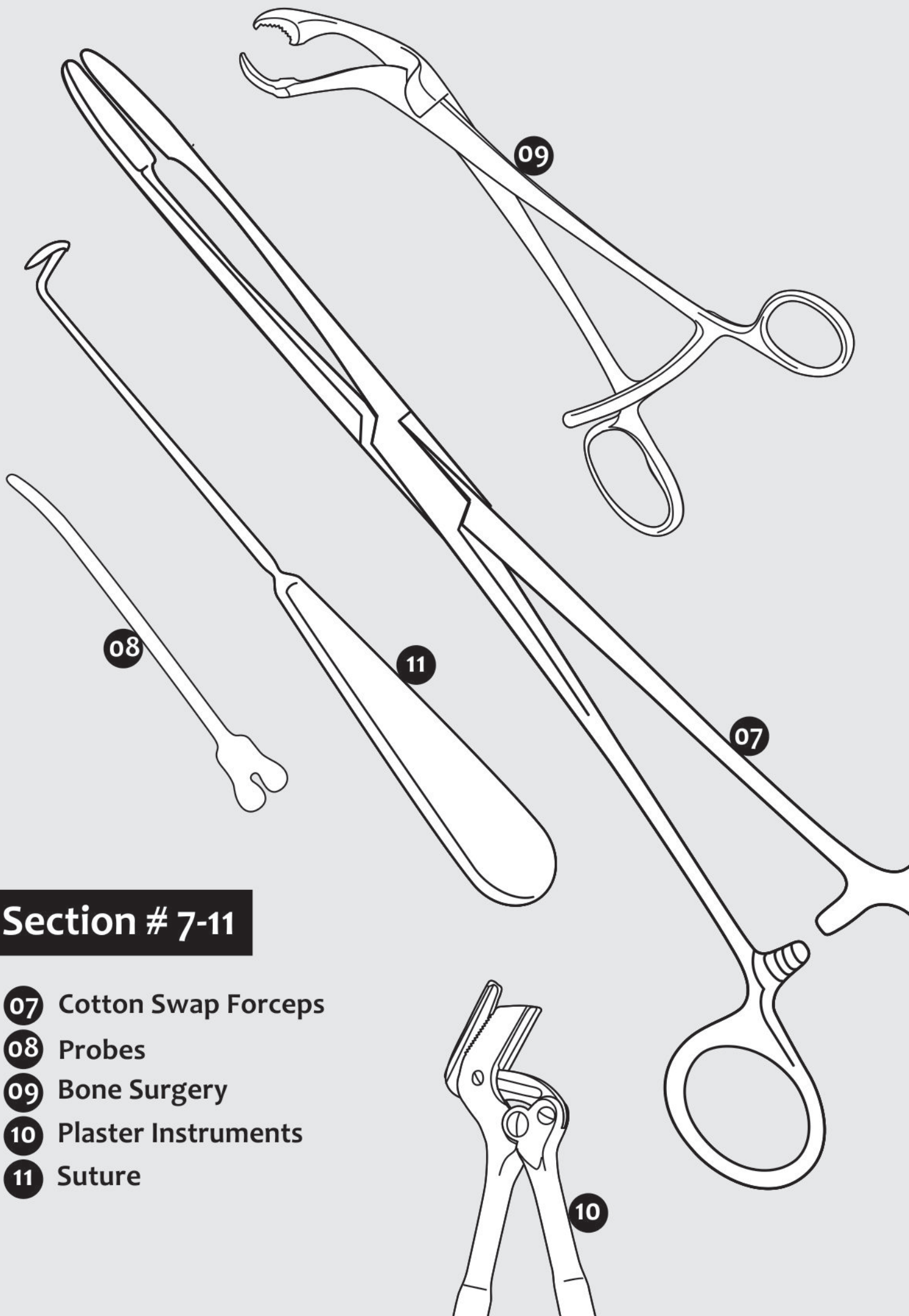

Section # 7-11

- 07 Cotton Swap Forceps
- 08 Probes
- 09 Bone Surgery
- 10 Plaster Instruments
- 11 Suture

Dressing Forceps, Sinus Forceps,
Sponge Forceps



M.F.ELAHI MEDICAL CO
SERVING WORLDWIDE SURGICAL INSTRUMENTS

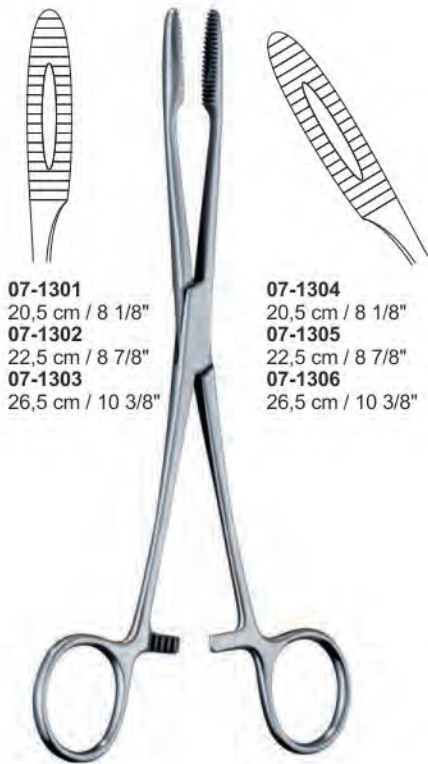

07-1301
20,5 cm / 8 1/8"
07-1302
22,5 cm / 8 7/8"
07-1303
26,5 cm / 10 3/8"

07-1304
20,5 cm / 8 1/8"
07-1305
22,5 cm / 8 7/8"
07-1306
26,5 cm / 10 3/8"

Gross-Maier
07-1301-1306

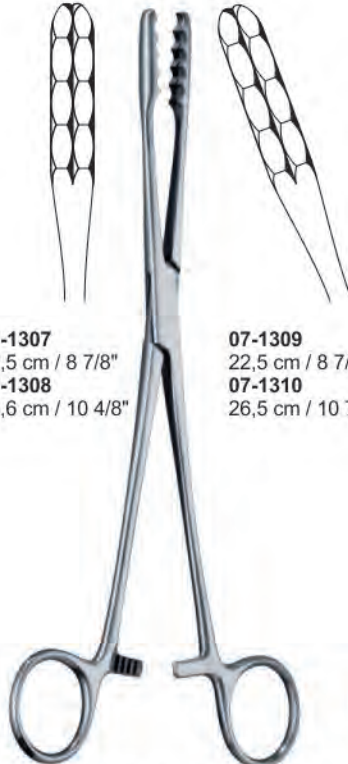

07-1307
22,5 cm / 8 7/8"
07-1308
26,6 cm / 10 4/8"

07-1309
22,5 cm / 8 7/8"
07-1310
26,5 cm / 10 7/8"

Ulrich
07-1307-1310

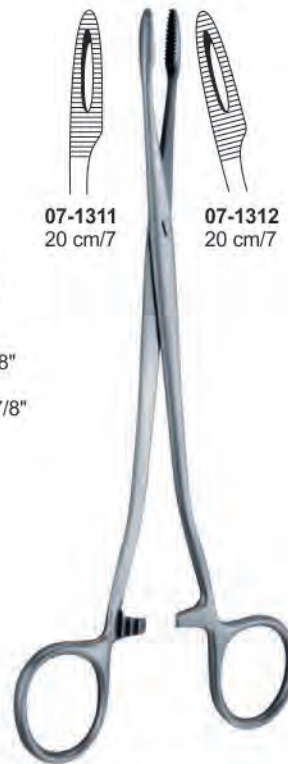

07-1311
20 cm/7"

07-1312
20 cm/7"

Duplay
07-1311-1312



07-1313
25 cm/9 7/8"

07-1314
25 cm/9 7/8"

Pelkmann
07-1313-1314
25 cm/9 7/8"



Collin
07-1315
25 cm / 9 7/8"



Cheron
07-1316
25 cm / 9 7/8"



Bozemann
07-1317
26 cm / 10 2/8"
S-Form / S-shape
curve in forma S

07-1318
25 cm / 9 7/8"
glattes Maul
smooth jaw
boca lisa
mors lisse
morso liscio

07-1319
24,5 cm / 9 5/8"
glattes Maul
smooth jaw
boca lisa
mors lisse
morso liscio

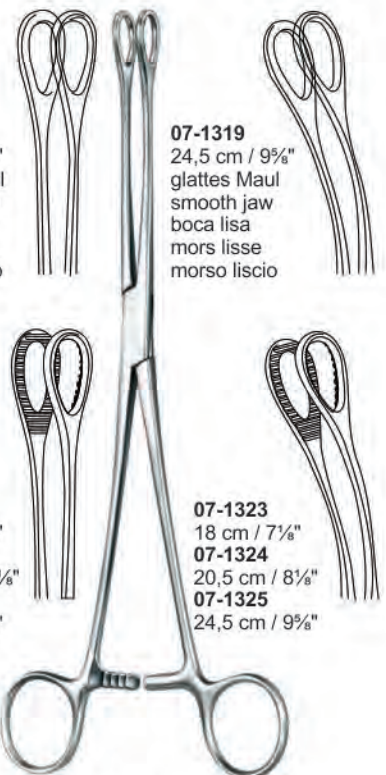

07-1320
18 cm / 7 1/8"
07-1321
20,5 cm / 8 1/8"
07-1322
25 cm / 9 7/8"

07-1323
18 cm / 7 1/8"
07-1324
20,5 cm / 8 1/8"
07-1325
24,5 cm / 9 7/8"

Forster
07-1318-1325



Dressing Forceps, Sinus Forceps,
Sponge Forceps



M.F.ELAHI MEDICAL CO
SERVING WORLDWIDE SURGICAL INSTRUMENTS



07-1326
18.5 cm / 7 1/4"



07-1327
24.5 cm / 9 5/8"



Rampley
07-1326-1327

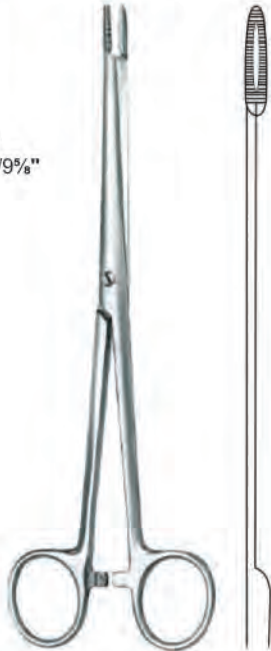

Martin
07-1328
17,5 cm / 6 7/8"



07-1329
13 cm / 5 1/8"



07-1330
16 cm / 6 2/8"



Lister
07-1329-1331



07-1331
18,5 cm / 7 2/8"



Emmet
07-1332
21 cm / 8 1/4"



Tunneling Forceps
07-1333
39,5 cm / 15 4/8"



Bryant
07-1334
13,5 cm / 5"



Fletcher (javers)
07-1335
24 cm / 9 1/2"

Probes, Seeker and Directors,
Cotton Applicators



M.F. ELAHI MEDICAL CO
SERVING WORLDWIDE SURGICAL INSTRUMENTS



Silver
08-1401



Fish
08-1402
14.5cm
18.0cm



Stacke
08-1403
Ø 1 mm
10 cm / 3 7/8"



Doyen
08-1404
14.0cm



Nelaton
08-1405
16.0cm



Kronecker
08-1406
13.0 cm



Johns-hopkins
08-1407
13.0 cm



ROSER
08-1408
12.5 cm



SYME
08-1409
17.0 cm



08-1410
17.0 cm



Farrel
08-1411 12.0cm
08-1412 14.0cm
08-1413 16.0cm
08-1414 18.0cm
08-1415 23.0cm



Jobson-horne
08-1416
12.5cm
08-1417
18.0cm



Myrtle Leaf Probe
08-1418-1422

- 08-1418
13 cm / 5 1/8" Ø 2,0 mm
- 08-1419
14,5 cm / 5 6/8" Ø 2,0 mm
- 08-1420
16 cm / 6 2/8" Ø 2,0 mm
- 08-1421
18 cm / 7 1/8" Ø 2,0 mm
- 08-1422
20 cm / 7 7/8" Ø 2,0 mm



08-1423
16,5 cm / 6 1/8"



08-1424
16,5 cm / 6 1/8"

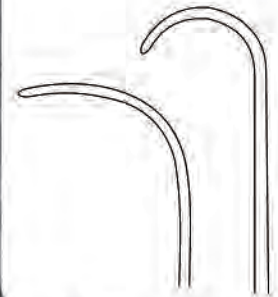

08-1425
16,5 cm / 6 1/8"



08-1426
16,5 cm / 6 1/8"



Lockhart-Mummery
08-1423-1426



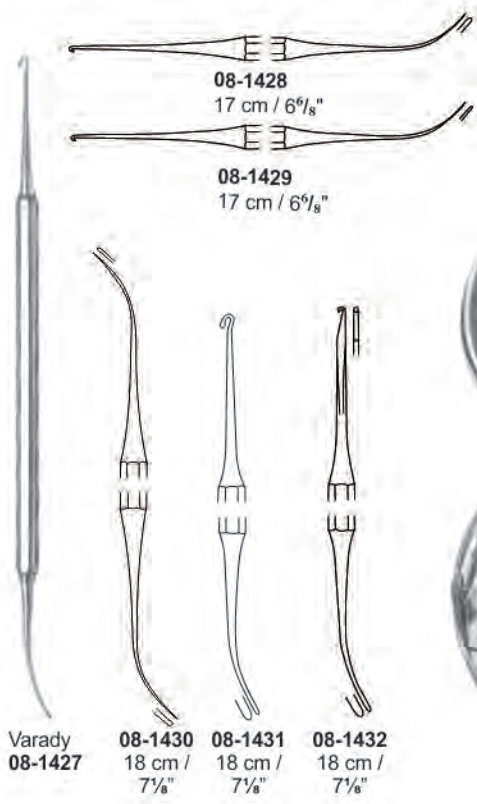

Nabatoff
08-1433

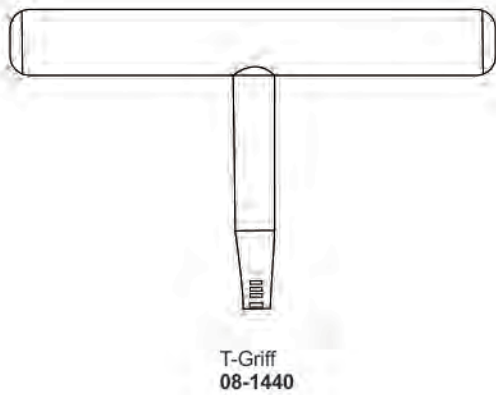
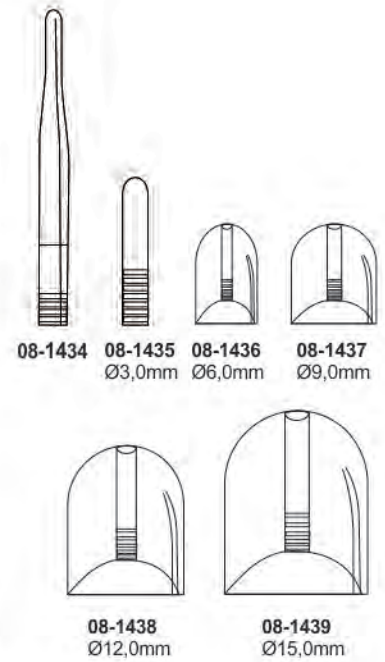

T-Griff
08-1440

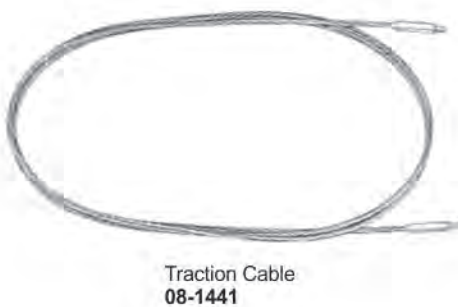

Traction Cable
08-1441

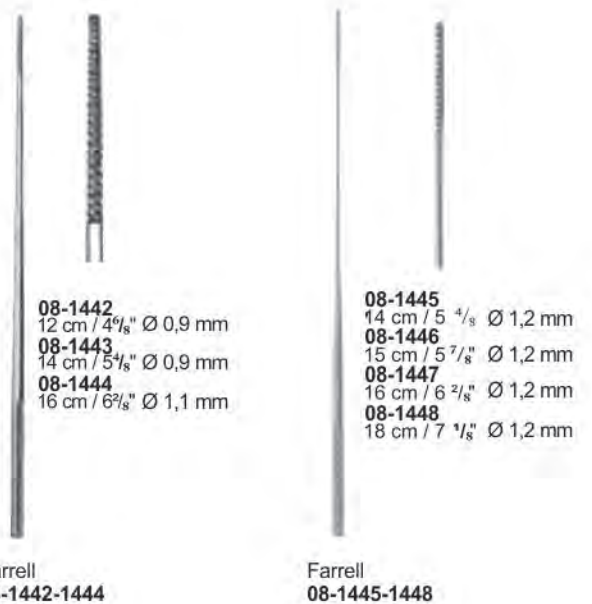

Farrell
08-1442-1444

Farrell
08-1445-1448





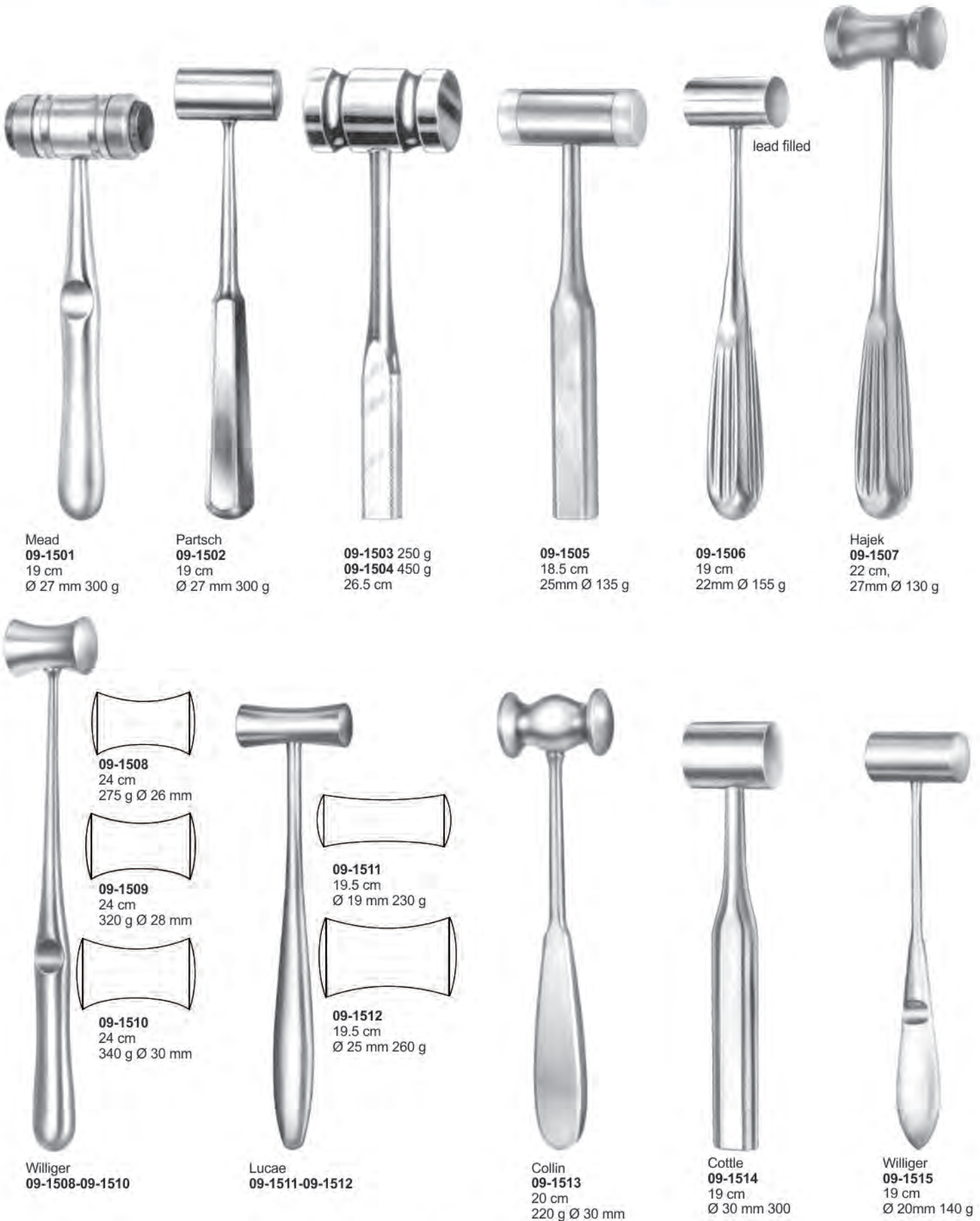







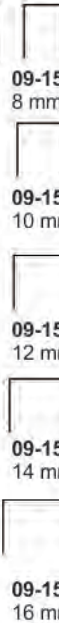

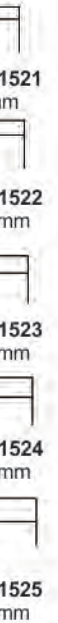

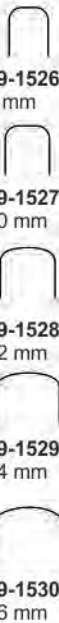

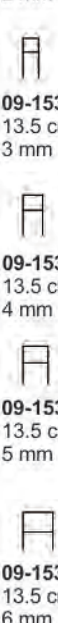
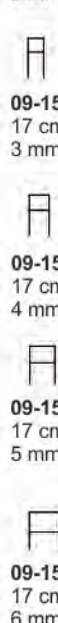

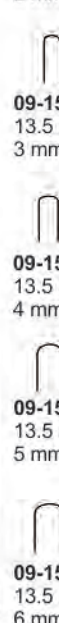
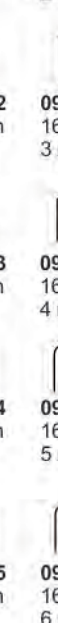
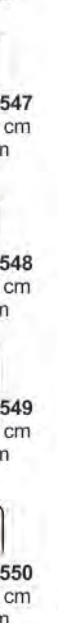

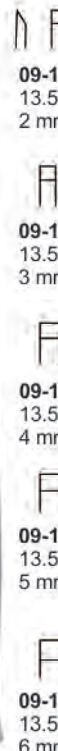
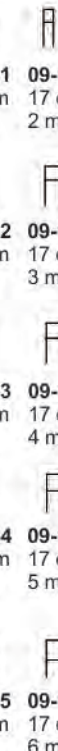

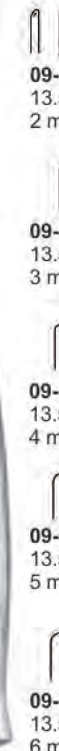
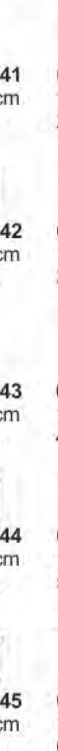





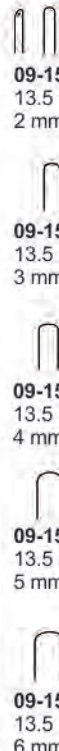
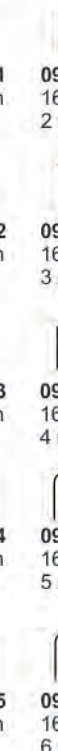

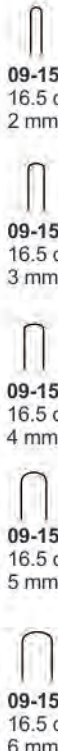

Mallets

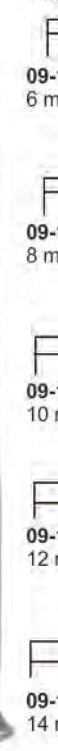

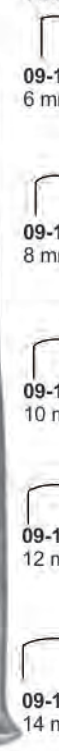

















Osteotomes, Chisels, Gouges, Spongiosa Gouges

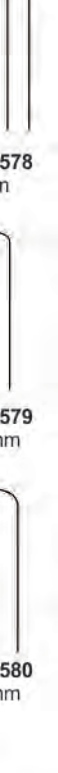

M.F. ELAHI MEDICAL CO
SERVING WORLDWIDE SURGICAL INSTRUMENTS

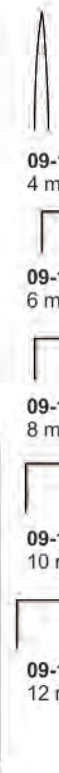
 09-1516 8 mm	 09-1517 10 mm	 09-1518 12 mm	 09-1519 14 mm	 09-1520 16 mm	 09-1521 8 mm	 09-1522 10 mm	 09-1523 12 mm	 09-1524 14 mm	 09-1525 16 mm	 09-1526 8 mm	 09-1527 10 mm	 09-1528 12 mm	 09-1529 14 mm	 09-1530 16 mm	 09-1531 13.5 cm 2 mm	 09-1532 13.5 cm 3 mm	 09-1533 13.5 cm 4 mm	 09-1534 13.5 cm 5 mm	 09-1535 13.5 cm 6 mm	 09-1536 17 cm 2 mm	 09-1537 17 cm 3 mm	 09-1538 17 cm 4 mm	 09-1539 17 cm 5 mm	 09-1540 17 cm 6 mm	 09-1541 13.5 cm 2 mm	 09-1542 13.5 cm 3 mm	 09-1543 13.5 cm 4 mm	 09-1544 13.5 cm 5 mm	 09-1545 13.5 cm 6 mm	 09-1546 16.5 cm 2 mm	 09-1547 16.5 cm 3 mm	 09-1548 16.5 cm 4 mm	 09-1549 16.5 cm 5 mm	 09-1550 16.5 cm 6 mm	 09-1551 4 mm 6 mm	 09-1552 6 mm 8 mm	 09-1553 8 mm 10 mm	 09-1554 10 mm 12 mm	 09-1555 12 mm 14 mm	 09-1556 14 mm 16 mm	 09-1557 4 mm 8 mm	 09-1558 6 mm 10 mm	 09-1559 8 mm 12 mm	 09-1560 10 mm 14 mm	 09-1561 12 mm 16 mm	 09-1562 14 mm 16 mm
09-1516-09-1520 13.5 cm					09-1521-09-1525 13.5 cm					09-1526-09-1530 13.5 cm					Partsch 09-1531-09-1540					Partsch 09-1541-09-1550					Alexander 09-1551-09-1556 17.5 cm					Alexander 09-1557-09-1562 17.5 cm																

 09-1563 10 mm	 09-1564 15 mm	 09-1565 20 mm	 09-1566 25 mm	 09-1567 10 mm	 09-1568 15 mm	 09-1569 20 mm	 09-1570 25 mm	 09-1571 10 mm	 09-1572 15 mm	 09-1573 20 mm	 09-1574 25 mm	 09-1575 5 mm	 09-1576 10 mm	 09-1577 15 mm	 09-1578 5 mm	 09-1579 10 mm	 09-1580 15 mm	 09-1581 4 mm	 09-1582 6 mm	 09-1583 8 mm	 09-1584 10 mm	 09-1585 12 mm
Stille 09-1563-09-1566 20.5 cm				Stille 09-1567-09-1570 20.5 cm				Stille 09-1571-9-1554 20.5 cm				Lexer 09-1575-09-1577 24.5 cm			Lexer 09-1578-09-1580 24.5 cm			Lexer-Mini 09-1581-09-1585 18 cm				













Osteotomes, Gouges

<p>09-1586 4 mm</p> <p>09-1587 6 mm</p> <p>09-1588 8 mm</p> <p>09-1589 10 mm</p> <p>09-1590 12 mm</p> <p>Lexer-Mini 09-1586-09-1590 18 cm</p>	<p>09-1591 7 mm</p> <p>09-1592 10 mm</p> <p>09-1593 15 mm</p> <p>09-1594 20 mm</p> <p>09-1595 25 mm</p> <p>09-1596 30 mm</p> <p>Lexer 09-1591-09-1596 22 cm</p>	<p>09-1597 7 mm</p> <p>09-1598 10 mm</p> <p>09-1599 15 mm</p> <p>09-1600 20 mm</p> <p>09-1601 25 mm</p> <p>09-1602 30 mm</p> <p>Lexer 09-1597-09-1602 22 cm</p>	<p>09-1603 2 mm</p> <p>09-1604 4 mm</p> <p>09-1605 8 mm</p> <p>09-1606 12 mm</p> <p>09-1607 3 mm</p> <p>09-1608 6 mm</p> <p>09-1609 10 mm</p> <p>09-1610 15 mm</p> <p>Lambotte-Mini 09-1603-09-1610 12.5 cm</p>	<p>09-1611 3 mm</p> <p>09-1612 6 mm</p> <p>09-1613 10 mm</p> <p>09-1614 15 mm</p> <p>09-1615 4 mm</p> <p>09-1616 8 mm</p> <p>09-1617 12 mm</p> <p>Lambotte-Mini 09-1611-09-1617 17 cm</p>	
<p>09-1618 15 mm</p> <p>09-1619 20 mm</p> <p>09-1620 25 mm</p> <p>09-1621 30 mm</p> <p>09-1622 38 mm</p> <p>09-1623 44 mm</p> <p>09-1624 50 mm</p> <p>Lambotte 09-1618-09-1624 24 cm</p>	<p>09-1625 15 mm</p> <p>09-1626 20 mm</p> <p>09-1627 25 mm</p> <p>09-1628 30 mm</p> <p>09-1629 38 mm</p> <p>09-1630 44 mm</p> <p>09-1631 50 mm</p> <p>Lambotte 09-1625-09-1631 24 cm</p>	<p>09-1632 6 mm</p> <p>09-1633 9 mm</p> <p>09-1634 13 mm</p> <p>09-1635 16 mm</p> <p>09-1636 19 mm</p> <p>09-1637 25 mm</p> <p>09-1638 32 mm</p> <p>Smith-Petersen 09-1632-09-1638 20.5 cm</p>	<p>09-1639 20.5 cm</p> <p>09-1640 9 mm</p> <p>09-1641 14 mm</p> <p>09-1642 19 mm</p> <p>09-1643 25 mm</p> <p>Smith-Petersen 09-1640-09-1643 20.5 cm</p>	<p>09-1644 20.5 cm</p> <p>09-1645 3 mm</p> <p>09-1646 5 mm</p> <p>09-1647 6 mm</p> <p>09-1648 8 mm</p> <p>09-1649 9 mm</p> <p>Hoke 09-1645-09-1649 17 cm</p>	<p>09-1650 30 cm</p> <p>09-1651 27 cm</p> <p>Putti 09-1650 30 cm</p> <p>Putti 09-1651 27 cm</p>



Bone Curettes

 <p>Fig. 1 09-1652</p> <p>Fig. 2 09-1653</p> <p>Fig. 3 09-1654</p> <p>Fig. 4 09-1655</p> <p>Fig. 5 09-1656</p> <p>Fig. 6 09-1657</p> <p>Fig. 0 09-1658</p> <p>Fig. 00 09-1659</p> <p>Fig. 000 09-1660</p> <p>Fig. 0000 09-1661</p> <p>Volkmanm 09-1652-09-1661 17 cm</p>	 <p>Fig. 1 09-1662</p> <p>Fig. 2 09-1663</p> <p>Fig. 3 09-1664</p> <p>Fig. 4 09-1665</p> <p>Fig. 0 09-1666</p> <p>Volkmanm 09-1662-09-1666 27 cm</p>	 <p>Fig. 0 09-1667</p> <p>Fig. 00 09-1668</p> <p>Fig. 000 09-1669</p> <p>Fig. 1 09-1670</p> <p>Fig. 2 09-1671</p> <p>Fig. 3 09-1672</p> <p>Fig. 4 09-1673</p> <p>Schede 09-1667-09-1673 17 cm</p>	 <p>Fig. 0 09-1674</p> <p>Fig. 000 09-1676</p> <p>Fig. 1 09-1678</p> <p>Fig. 3 09-1680</p> <p>Fig. 5 09-1682</p> <p>Volkmanm 09-1674-09-1683 17 cm</p>	 <p>Fig. 00 09-1675</p> <p>Fig. 0000 09-1677</p> <p>Fig. 2 09-1679</p> <p>Fig. 4 09-1681</p> <p>Fig. 6 09-1683</p> <p>Bruns 09-1684-09-1693 17 cm</p>	<p>Fig. 00 09-1684</p> <p>Fig. 00 09-1685</p> <p>Fig. 000 09-1686</p> <p>Fig. 0000 09-1687</p> <p>Fig. 1 09-1688</p> <p>Fig. 2 09-1689</p> <p>Fig. 3 09-1690</p> <p>Fig. 4 09-1691</p> <p>Fig. 5 09-1692</p> <p>Fig. 6 09-1693</p>
 <p>Fig. 0 09-1694</p> <p>Fig. 00 09-1695</p> <p>Fig. 000 09-1696</p> <p>Fig. 1 09-1697</p> <p>Fig. 2 09-1698</p> <p>Fig. 3 09-1699</p> <p>Fig. 4 09-1700</p> <p>Fig. 5 09-1701</p> <p>Fig. 6 09-1702</p> <p>Volkmanm 09-1694-09-1702 23 cm</p>	 <p>09-1703</p> <p>09-1704</p> <p>09-1705</p> <p>Volkmanm 09-1703-09-1705 25 cm</p>	 <p>Fig. 1 09-1706</p> <p>Fig. 2 09-1707</p> <p>Fig. 3 09-1708</p> <p>Fig. 4 09-1709</p> <p>Fig. 5 09-1710</p> <p>Fig. 6 09-1711</p> <p>Modell USA 09-1706-09-1711 16.5 cm</p>	 <p>Fig. 1 09-1712</p> <p>Fig. 2 09-1713</p> <p>Fig. 3 09-1714</p> <p>Fig. 4 09-1715</p> <p>Fig. 5 09-1716</p> <p>Fig. 6 09-1717</p> <p>Modell USA 09-1712-09-1717 16 cm</p>	 <p>Fig. 1 09-1718</p> <p>Fig. 2 09-1719</p> <p>Fig. 3 09-1720</p> <p>Fig. 4 09-1721</p> <p>Fig. 5 09-1722</p> <p>Fig. 6 09-1723</p> <p>Modell USA 09-1718-09-1723 16.5 cm</p>	



Bone Curettes



Fig. 1
09-1724

Fig. 2
09-1725

Fig. 3
09-1726

Halle
09-1724-09-1726
21 cm



Volkmann
09-1727-09-1729

09-1727 12.5 cm 09-1728 14.5 cm 09-1729 17 cm



Volkmann
09-1730-09-1732

09-1730 13 cm 09-1731 16 cm 09-1732 20 cm



Simon
09-1733-09-1738
22.5 cm

Fig. 1 09-1733
Fig. 2 09-1734
Fig. 3 09-1735
Fig. 4 09-1736
Fig. 5 09-1737
Fig. 6 09-1738



Williger
09-1739-09-1741
14 cm

Fig. 00/0 09-1739 Fig. 0/1 09-1740 Fig. 1/2 09-1741



Williger
09-1742-09-1744
16.5 cm

Fig. 00/00 09-1742 Fig. 0/0 09-1743 Fig. 1/1 09-1744



Molt
09-1745-09-1749

Fig. 1 09-1745 17 cm Fig. 2 09-1746 17 cm Fig. 4 09-1747 17 cm

Fig. 5 09-1748 17.5 cm Fig. 6 09-1749 17.5 cm



Molt
09-1750
19 cm



Periosteal Elevators



M.F.ELAHI MEDICAL CO
SERVING WORLDWIDE SURGICAL INSTRUMENTS



Langenbeck
09-1751
18 cm



Langenbeck
09-1752
19 cm

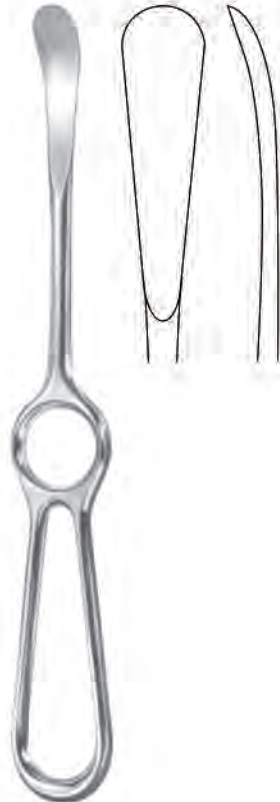

Sedillot
09-1753
22 cm



Farabeuf
09-1754
15.5 cm



Farabeuf
09-1755
15.5 cm



Williger
09-1756
12.5 cm
6 mm



Kahre-Williger
09-1757-09-1758
16.5 cm



4 mm
09-1757
16.5 cm

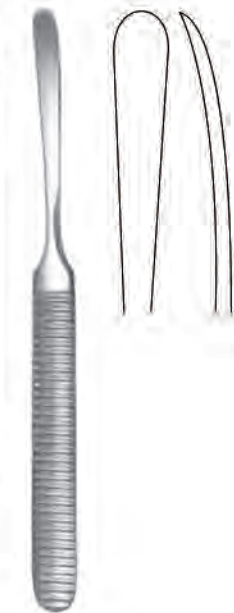

5 mm
09-1758
16.5 cm



Williger
09-1760
16 cm
5 mm



Alexander
09-1761
21 cm



Semb
09-1762



Doyen
09-1763-09-1766
17.5 cm



09-1763

09-1764

09-1765

09-1766



Bone Files, Elevators



M.F. ELAHI MEDICAL CO
SERVING WORLDWIDE SURGICAL INSTRUMENTS



09-1767
28 cm



09-1768
25 cm



09-1769
22 cm



Miller-Colburn
09-1770-09-1774
18 cm



Fig. 1
09-1770
18 cm



Fig. 2
09-1771
18 cm



Fig. 3
09-1772
18 cm



Fig. 4
09-1773
18 cm



Fig. 5
09-1774
18 cm



Alderdyce
09-1775
21 cm



Miller-Colburn
09-1776-09-1779
18 cm



Fig. 1
09-1776
18 cm



Fig. 2
09-1777
18 cm



Fig. 3
09-1778
18 cm



Fig. 4
09-1779
18 cm



Langenbeck
09-1780-09-1781
19.5 cm



09-1780
19.5 cm
7mm



09-1781
19.5 cm
10mm



Williger
09-1782
17 cm
7mm



Williger
09-1783
16 cm
4mm



McDonald
09-1784
18.5 cm

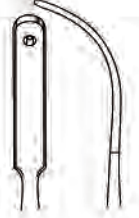

Bone Levers



M.F.ELAHI MEDICAL CO
SERVING WORLDWIDE SURGICAL INSTRUMENTS



09-1785
16 cm
6 mm

Hohmann, mini
09-1785-09-1786
16 cm



09-1786
16 cm
8 mm

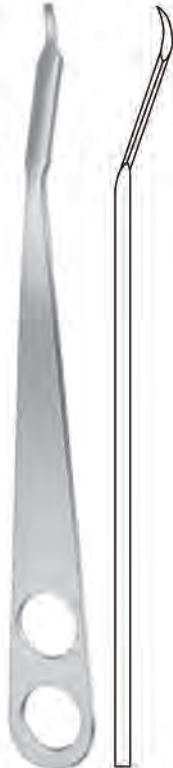

Hohmann
09-1787
21.5 cm
8 mm



Hohmann
09-1788
23.5 cm
18 mm



Hohmann
09-1789
23.5 cm
43 mm



Hohmann
09-1790
29 cm
35 mm



Hohmann
09-1791
25 cm
70 mm



Hohmann
09-1792
23.5 cm
43 mm



Hohmann
09-1793
25.5 cm
22 mm



Bennett
09-1794-09-1795
24 cm

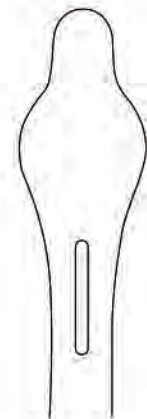

09-1794
24 cm
43 mm

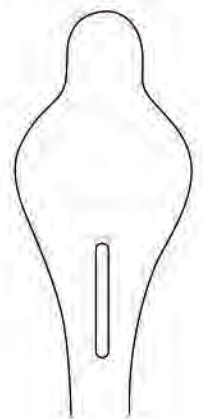

09-1795
23.5 cm
60 mm



Knee Retractors, Spinal Retractors Tendon Holding Forceps, Tendon Tunelling Forceps



M.F. ELAHI MEDICAL CO
SERVING WORLDWIDE SURGICAL INSTRUMENTS



Blount
09-1796
26.5 cm
39 mm



Blount
09-1797
26.5 cm
47 mm



Blount
09-1798
17.5 cm

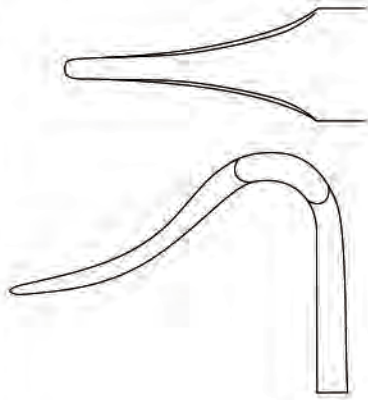

Taylor
09-1799-09-1800
16 cm

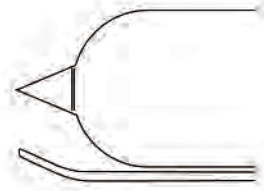

09-1799
16 cm
95 x 30 mm

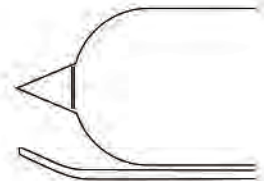

09-1800
16 cm
115 x 30 mm

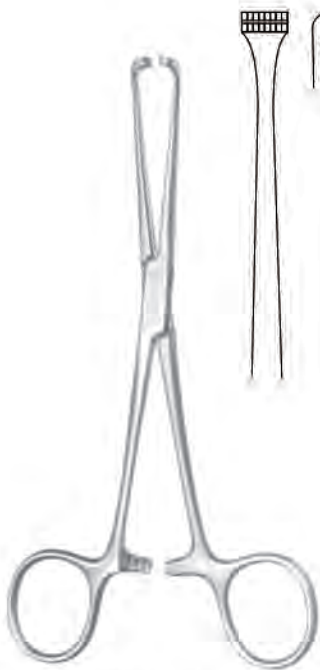

Steinmann
09-1801
16 cm



Brand
09-1802-09-1804



09-1802
15 cm



09-1803
19 cm



09-1804
24.5 cm

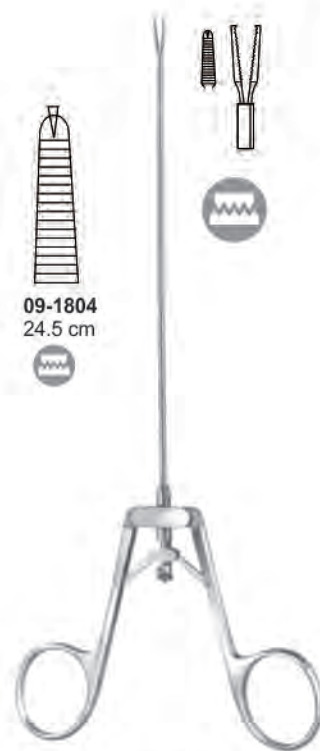

Kleinert-Kutz
09-1805
21 cm
140 mm



09-1806
14.5 cm

Cartilage Seizing Forceps, Bone Holding Forceps



M.F. ELAHI MEDICAL CO
SERVING WORLDWIDE SURGICAL INSTRUMENTS

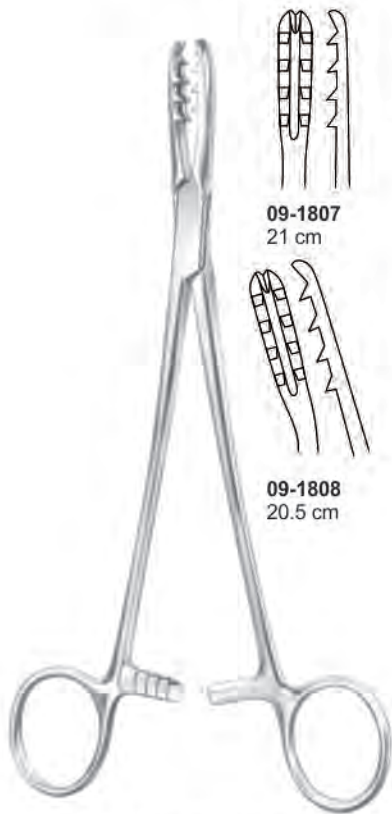

09-1807
21 cm

09-1808
20.5 cm

Bircher-Ganske
09-1807-09-1808

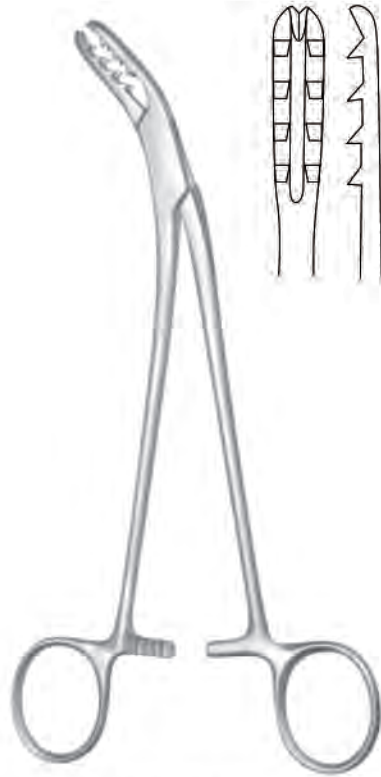

Bircher-Ganske
09-1809
20 cm



Dingmann
09-1810
18.5 cm



Langenbeck
09-1811
21 cm



Fergusson
09-1812
21 cm



Frosch
09-1813
18 cm



09-1814
20 cm



Bone Holding Forceps, Reposition Forceps



M.F.ELAHI MEDICAL CO
SERVING WORLDWIDE SURGICAL INSTRUMENTS



09-1815
17.5 cm

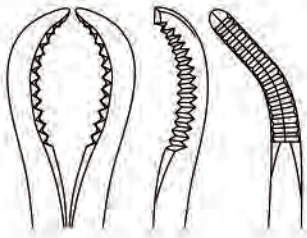

09-1816
24 cm

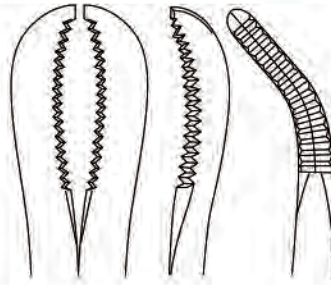

Kern
09-1817-09-1818
24 cm

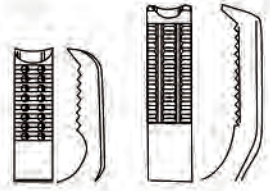

09-1817
17 cm

09-1818
21 cm



Semb
09-1819
19.5 cm

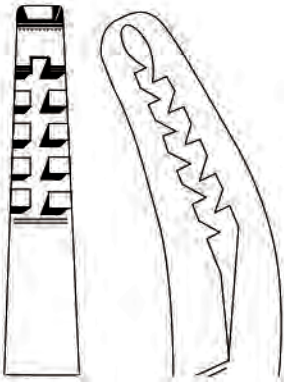

Farabeuf
09-1820-09-1821
19.5 cm

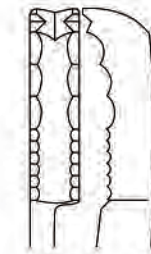

09-1820
23 cm

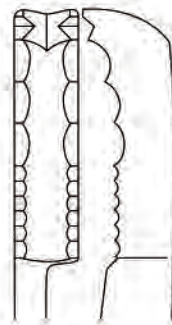

09-1821
26 cm



Farabeuf
09-1822
19.5 cm

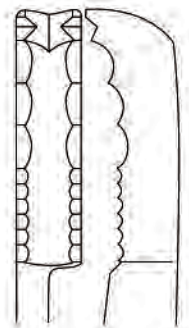

Bone Holding Forceps, Amputation Retractor



M.F. ELAHI MEDICAL CO
SERVING WORLDWIDE SURGICAL INSTRUMENTS

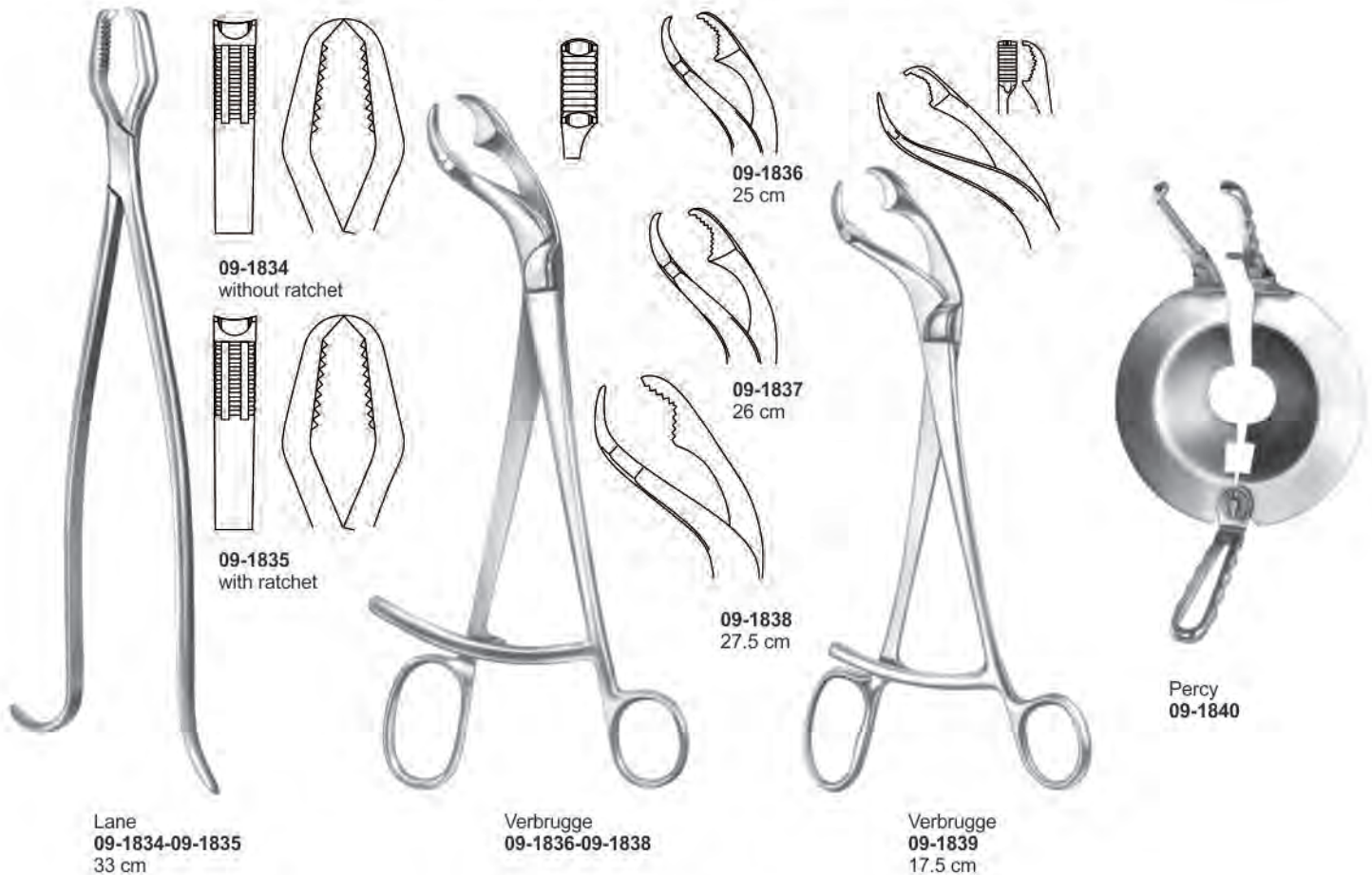
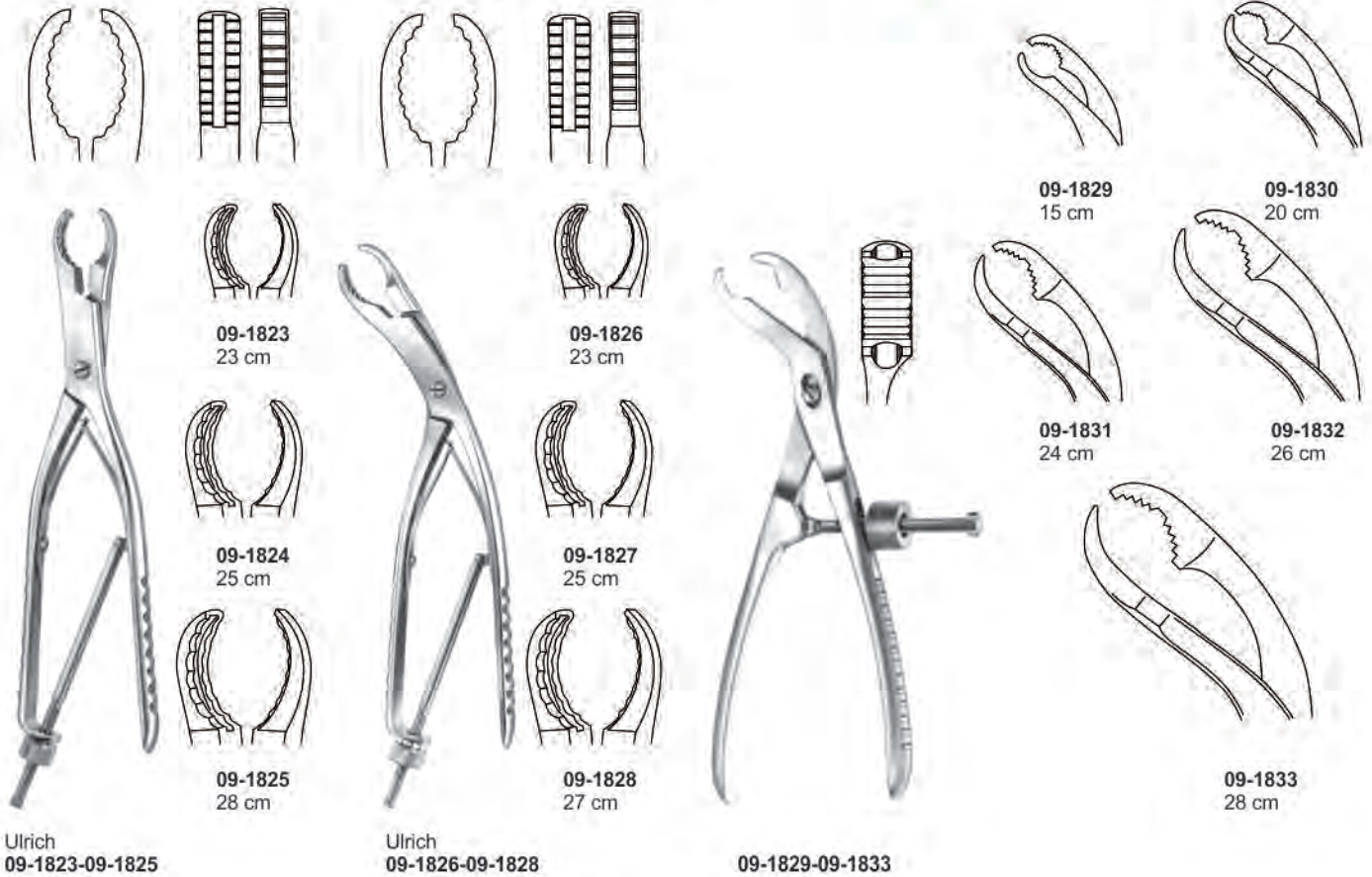

Bone Rongeurs



M.F. ELAHI MEDICAL CO
SERVING WORLDWIDE SURGICAL INSTRUMENTS

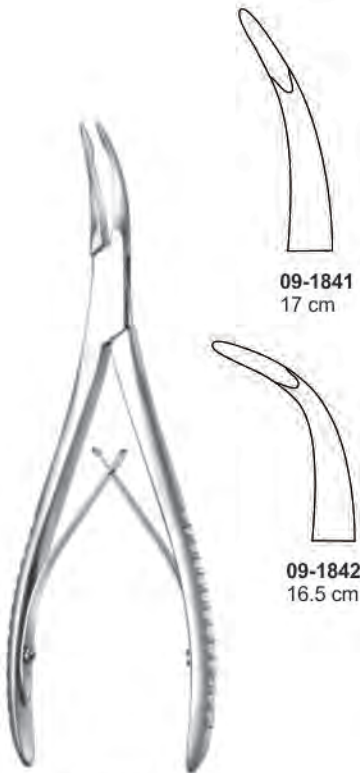

09-1841
17 cm

09-1842
16.5 cm

Stellbrink
09-1841



Friedmann
09-1843
12.5 cm



Friedmann
09-1844
13.5 cm



Friedmann
09-1845
13.5 cm



Cleveland
09-1846
13.5 cm

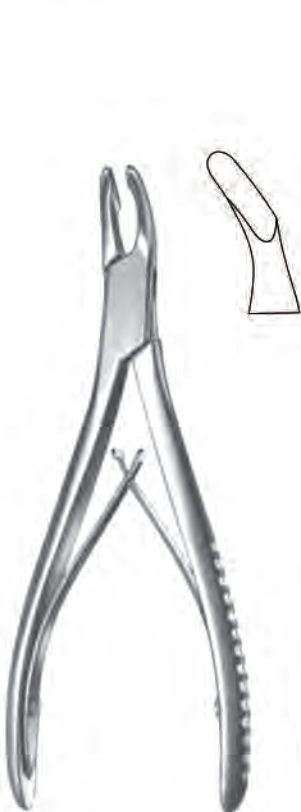

Cleveland
09-1847
16.5 cm



Mead
09-1848
16.5 cm



Hartmann
09-1849
17.5 cm

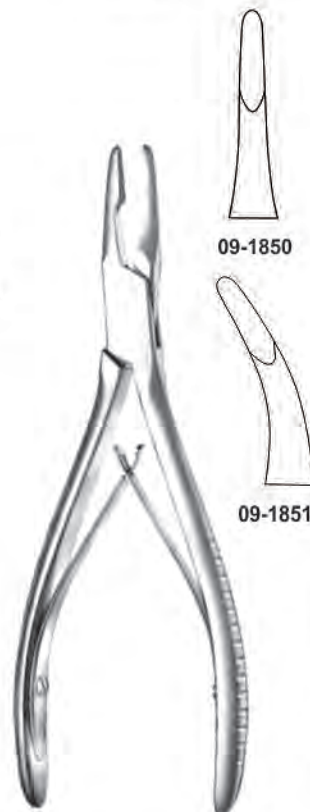

Jansen
09-1850-09-1851
18 cm



Lempert
09-1852
19 cm



Bone Rongeurs



M.F. ELAHI MEDICAL CO
SERVING WORLDWIDE SURGICAL INSTRUMENTS

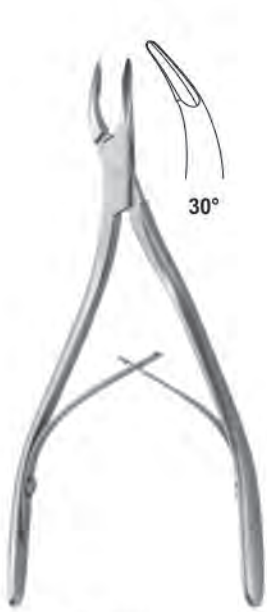

30°

09-1853
14.5 cm



09-1854
15.5 cm



09-1855
15.5 cm

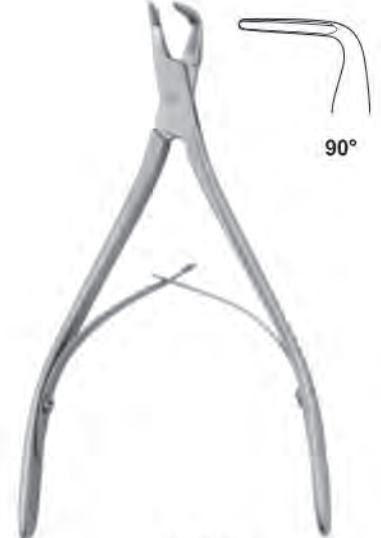

90°

09-1856
14.5 cm



Blumenthal
09-1857-09-1859



09-1857
16 cm



09-1858
15.5 cm



09-1859
15.5 cm



Luer
09-1860-09-1861



09-1860
18.5 cm



09-1861
18 cm



Luer
09-1862-09-1864



09-1862
14.5 cm

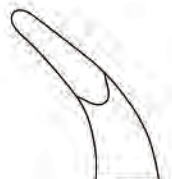

09-1863
14.5 cm

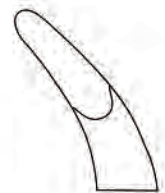

09-1864
14.5 cm

Bone Rongeurs



M.F.ELAHI MEDICAL CO
SERVING WORLDWIDE SURGICAL INSTRUMENTS

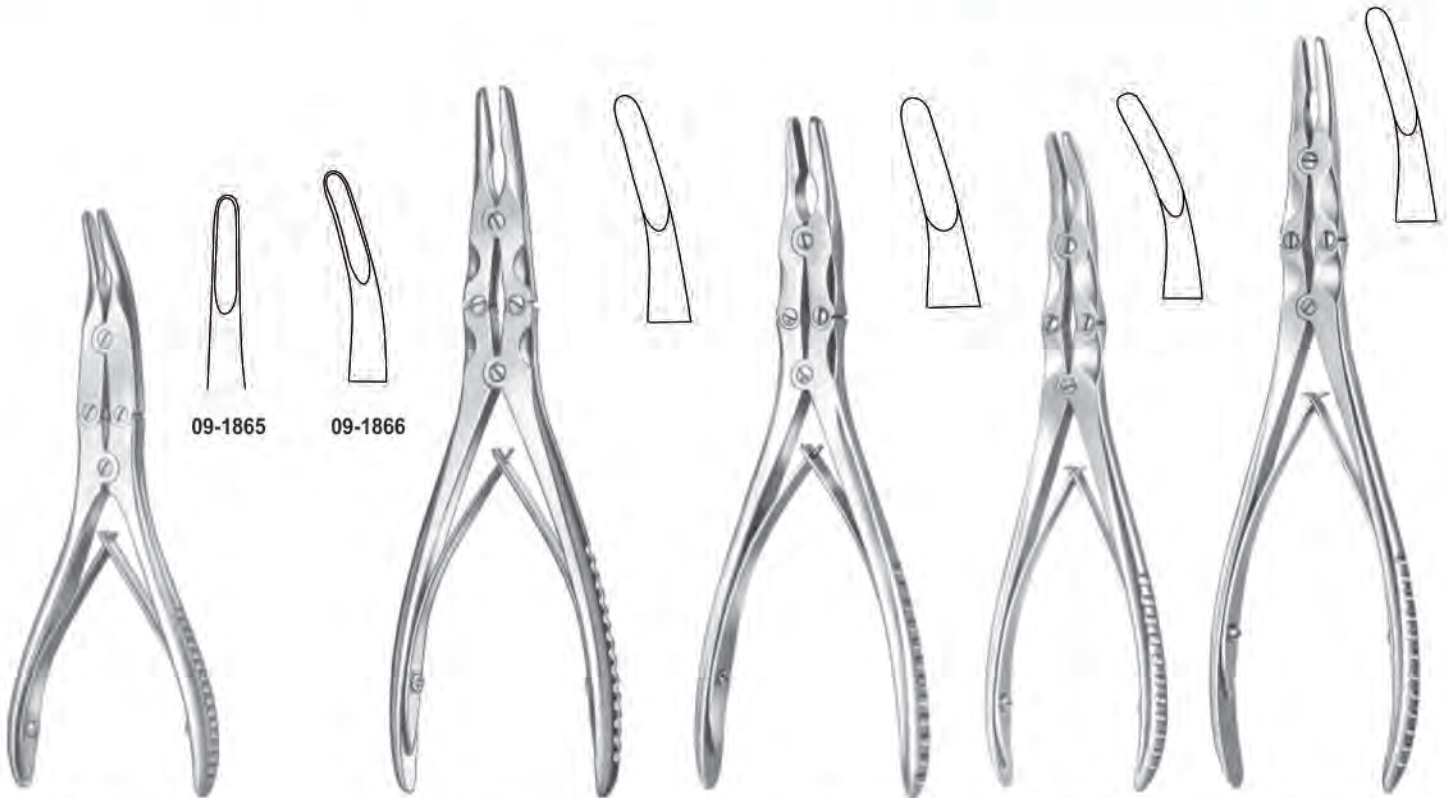

Böhler
09-1865-09-1866
15 cm

Beyer
09-1867
18 cm

Zaufal-Jansen
09-1868
18 cm

Mayfield
09-1869
18 cm

Marquard
09-1870
20.5 cm



Ruskin
09-1871
19 cm

Ruskin
09-1872
24 cm

Semb
09-1873
23.5 cm

Stille
09-1874
22.5 cm



Bone Rongeurs



M.F. ELAHI MEDICAL CO
SERVING WORLDWIDE SURGICAL INSTRUMENTS



Echlin
09-1875-09-1877
23 cm



09-1875
09-1876
09-1877



Stille-Ruskin
09-1878
23.5 cm



Leksell-Stille
09-1879-09-1880
24.5 cm

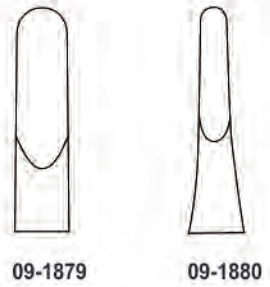

09-1879 09-1880



Frykholm
09-1881
24.5 cm



Stille-Luer
09-1882-09-1883
22.5 cm

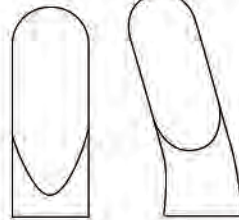

09-1882 09-1883



Stille-Luer
09-1884-09-1887

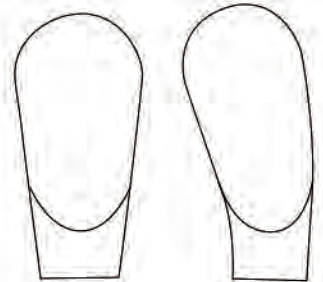

09-1884 23 cm 09-1885 23 cm
09-1886 27 cm 09-1887 27 cm



Bone Cutting Forceps



M.F.ELAHI MEDICAL CO
SERVING WORLDWIDE SURGICAL INSTRUMENTS



Cottle-Kazanjian
09-1888
19 cm



09-1889
14 cm



09-1890
17 cm



09-1893
14 cm



09-1894
17 cm



Liston
09-1889-09-1892
14 cm



09-1891
20 cm



09-1892
22 cm



Liston
09-1893-09-1896
14 cm



09-1895
20 cm



09-1896
22 cm



Cleveland
09-1897-09-1898
17 cm, 14.5 cm



09-1897



09-1898



Ruskin-Liston
09-1899-09-1900



09-1899
19 cm



09-1900
18.5 cm



Stille-Liston
09-1901
26 cm

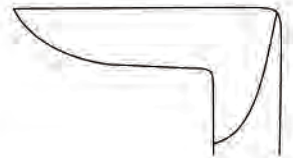



Bone Cutting Forceps



Stille-Liston
09-1902-09-1904



09-1902
28 cm



09-1903
23.5 cm



09-1904
28 cm



Liston-Key
09-1905
26 cm



Vickers
09-1906



Martin
09-1907
18.5 cm



Walton
09-1908
16 cm



Penner
09-1909
16 cm

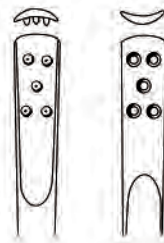

09-1910
14.5 cm



Radolf
09-1911
13.5 cm



Amputation Saws, Reamer, Hand Drills



M.F. ELAHI MEDICAL CO
SERVING WORLDWIDE SURGICAL INSTRUMENTS



Charrière
09-1912
35 cm



Langenbeck
09-1913
24 cm



Charrière
09-1914
26.5 cm



Satterlee
09-1915
29 cm



09-1916
13 cm



Perthes
09-1917
21.5 cm



09-1918
14 cm



Gerster-Lowman
09-1919-09-1922

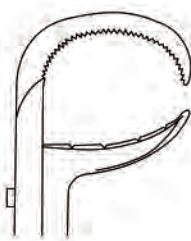

09-1919

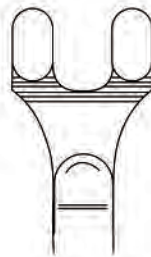

09-1920
18 cm / 7"

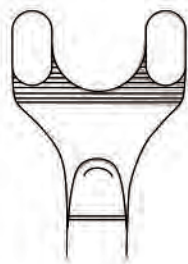

09-1921
20 cm / 8"

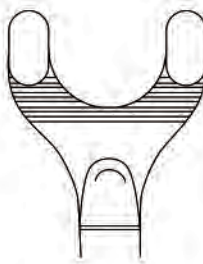

09-1922
22 cm / 8 5/8"



Gerster
09-1923



09-1924
18.5 cm



Vise Grip, Combi-Flat Nose Plier



M.F. ELAHI MEDICAL CO
SERVING WORLDWIDE SURGICAL INSTRUMENTS



09-1925
20,5 cm



09-1926
15 cm



09-1927-09-1929
18 cm



09-1927



09-1928



09-1929



09-1930
13.5 cm



09-1931
19 cm



Hackstock
09-1932
16 cm

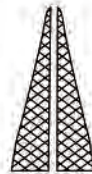

09-1933
17 cm



09-1934
19 cm



Wire Cutting Pliers, Wire Guides, Wire Tightener, Extension Bows



M.F. ELAHI MEDICAL CO
SERVING WORLDWIDE SURGICAL INSTRUMENTS



09-1935
18.5 cm



Martin "Diamant"
09-1936
16 cm



09-1937
55 cm



Demel
09-1938-09-1940

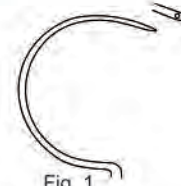

Fig. 1
09-1938
31 cm



Fig. 2
09-1939
29 cm



Fig. 3
09-1940
28 cm



Loute
09-1941
21 cm



Böhler
09-1942

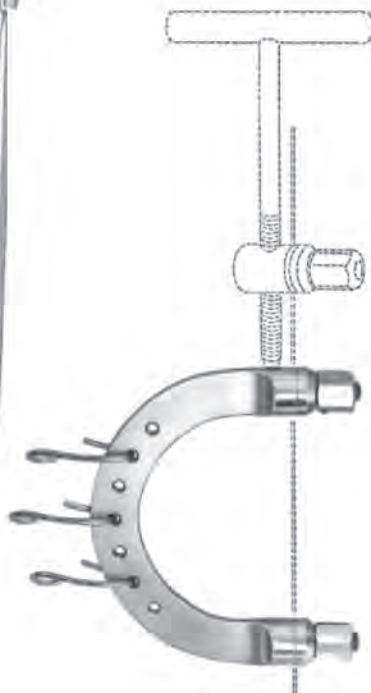

Kirschner
09-1943
95 x 70 mm



09-1944
18.5 cm



Kirschner
09-1945
18.5 cm



Kirschner
09-1946
95 x 70 mm



Bandage Scissors, Plaster Shears,
Plaster Knives, Plaster Breakers



M.F. ELAHI MEDICAL CO
SERVING WORLDWIDE SURGICAL INSTRUMENTS



Hopkins
10-2001
20 cm



Esmarch
10-2002
18 cm



Reiner
10-2003
18 cm



Martin
10-2004
20,5 cm



Wigmore
10-2005
19 cm



Hennig
10-2006
28 cm



Quattro
10-2007
23 cm

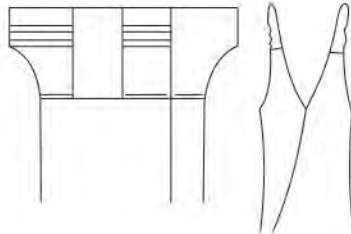

Wolff
10-2008-10-2009



10-2008
17,5 cm



10-2009
26,5 cm

Bandage Scissors, Plaster Shears,
Bandage Scissors



M.F. ELAHI MEDICAL CO
SERVING WORLDWIDE SURGICAL INSTRUMENTS

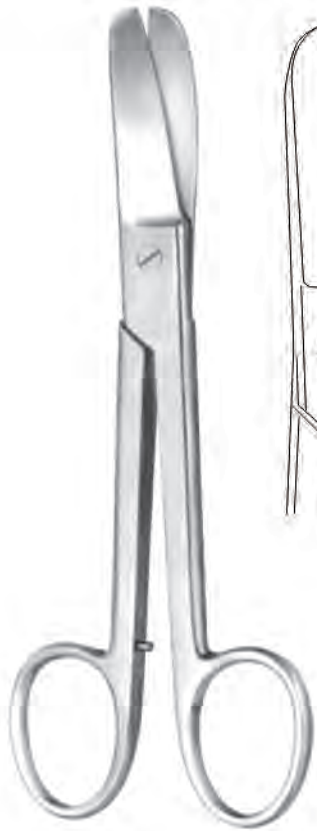

Lorenz
10-2010
24 cm

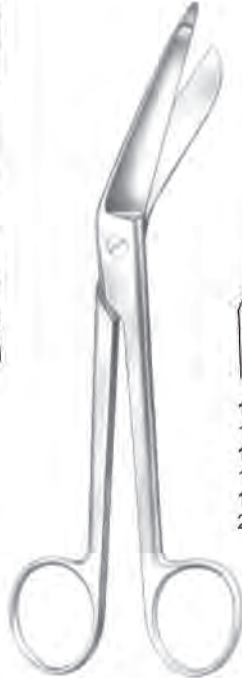

Lister
10-2011-2013

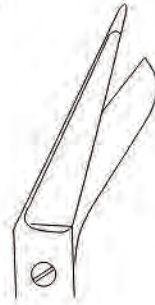

10-2011
14,5 cm
10-2012
18,5 cm
10-2013
20 cm

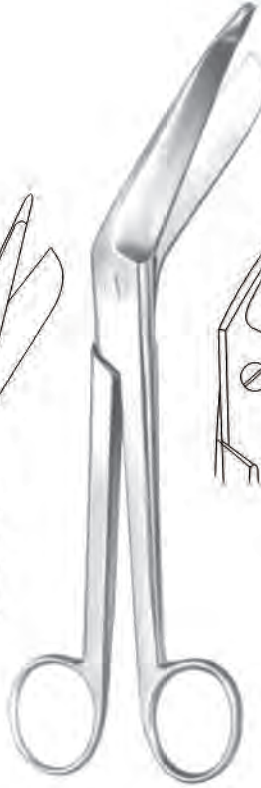

Bergmann
10-2014
23 cm

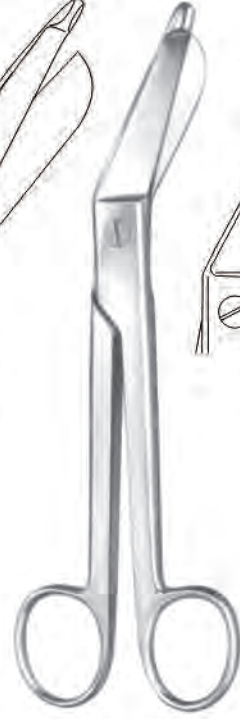
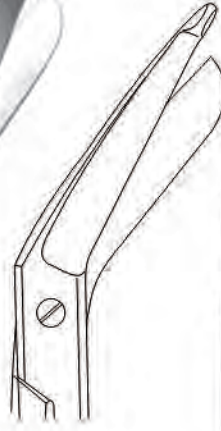

Esmarch
10-2015
20 cm

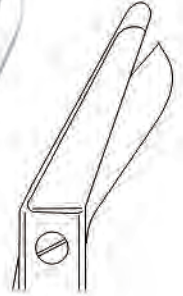

Universal
10-2016-10-2017
15,5 cm

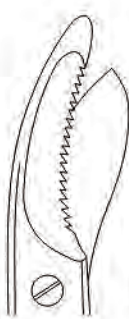

10-2016
24 cm



10-2017
24 cm



Bruns
10-2018-10-2020



10-2018
23 cm



10-2019
27 cm



10-2020
38 cm



Stille-Martin
10-2021



Stille
10-2022
24 cm



Needle Holders



M.F. ELAHI MEDICAL CO
SERVING WORLDWIDE SURGICAL INSTRUMENTS



Derf
11-2101
12 cm



Collier
11-2102
12.5 cm



Webster
11-2103
13 cm



Halsey
11-2104
13.5 cm



Neivert
11-2105
12.5 cm



Hegar-Baumgartner
11-2106
14 cm

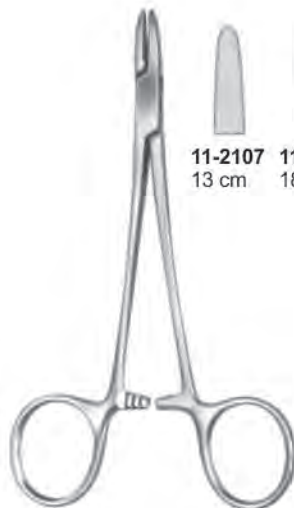

Brown
11-2107-11-2108
13 cm

11-2107 13 cm
11-2108 18 cm

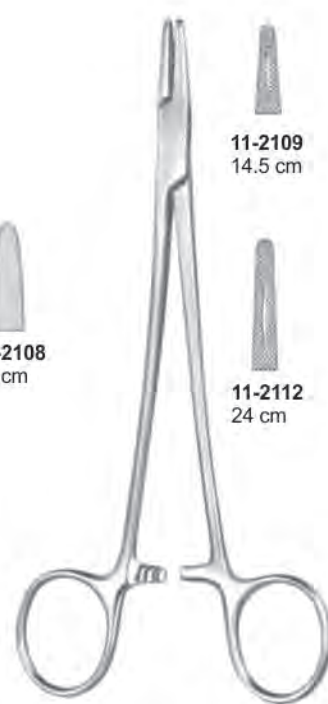

Mayo-Hegar
11-2109-11-2114

11-2109
14.5 cm

11-2110
16 cm

11-2111
18.5 cm

11-2112
24 cm

11-2113
26.5 cm

11-2114
30.5 cm

Needle Holders



M.F. ELAHI MEDICAL CO
SERVING WORLDWIDE SURGICAL INSTRUMENTS



Mayo-Hegar
11-2115-11-2117

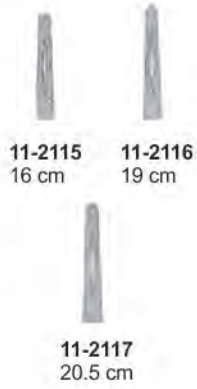

Crile-Murray
11-2118
15 cm



Crile-Wood
11-2119
15 cm



Hegar
11-2120
20 cm, 24 cm



Adson
11-2121
18.5 cm



Metzenbaum
11-2122
18.5 cm



M. G. Hospital
11-2123
18 cm



Heaney
11-2124
20.5 cm



Needle Holders



M.F. ELAHI MEDICAL CO
SERVING WORLDWIDE SURGICAL INSTRUMENTS

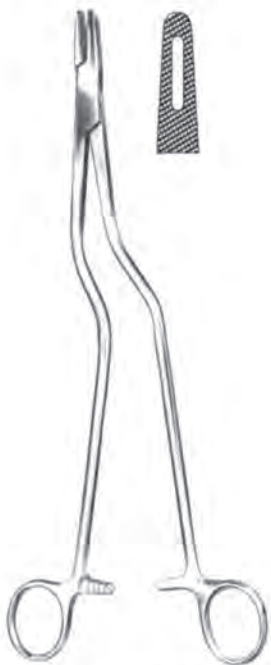

Masson-Luethy
11-2125
26 cm

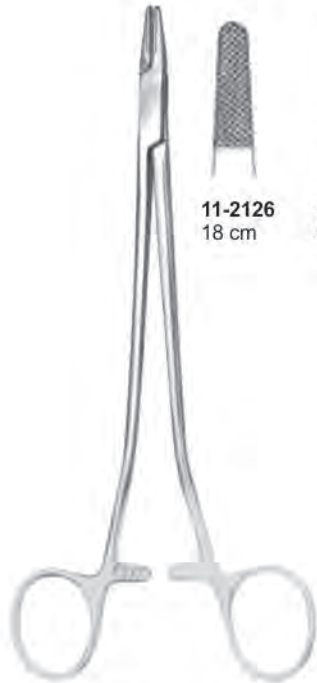

11-2126 18 cm
11-2127 20 cm
11-2128 26 cm

Sarot
11-2126-11-2128

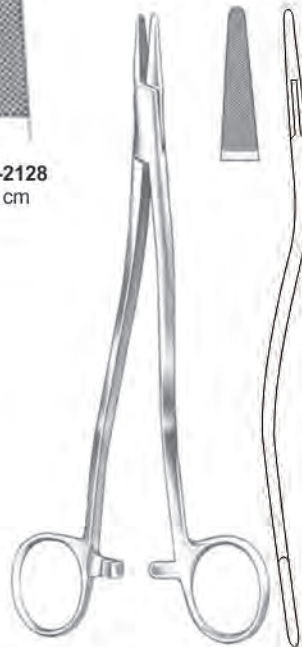

Wertheim
11-2129
20 cm, 24 cm

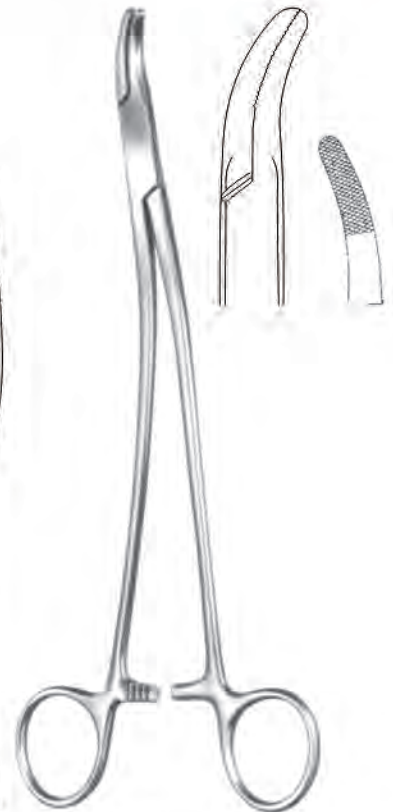

Stratte
11-2130
23 cm



Kilner
11-2131
14.5 cm



Bozemann
11-2132
20 cm, 24 cm



Wangensteen
11-2133
26.5 cm



Jamison
11-2134
23 cm



Needle Holders



M.F. ELAHI MEDICAL CO
SERVING WORLDWIDE SURGICAL INSTRUMENTS

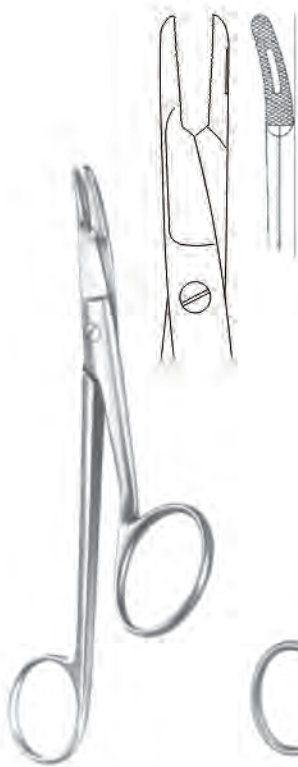

Gillies
11-2135
16 cm

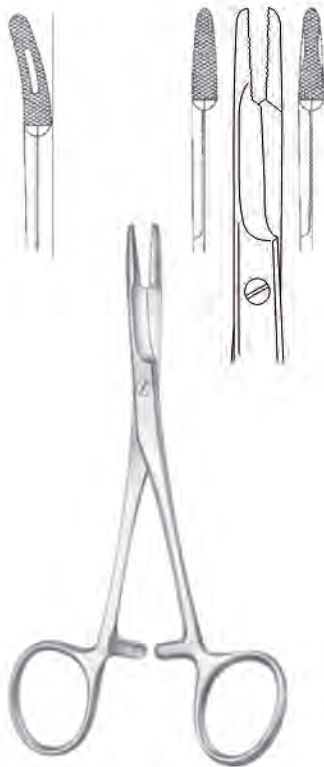

Olsen-Hegar
11-2136
14 cm

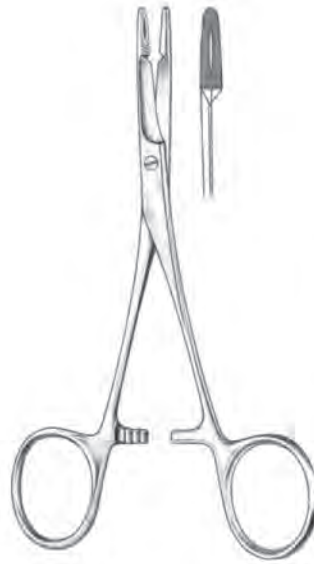

Olsen-Hegar
11-2137
14 cm



Crile
11-2138
15 cm



Toennis
11-2139
18.5 cm



Lichtenberg
11-2140
20 cm



Macphail
11-2141
14 cm, 16 cm
11-2142
18 cm, 20 cm



Mathieu
11-2143-11-2145

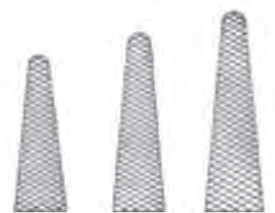

11-21423 14 cm
11-2144 17 cm
11-2145 20 cm

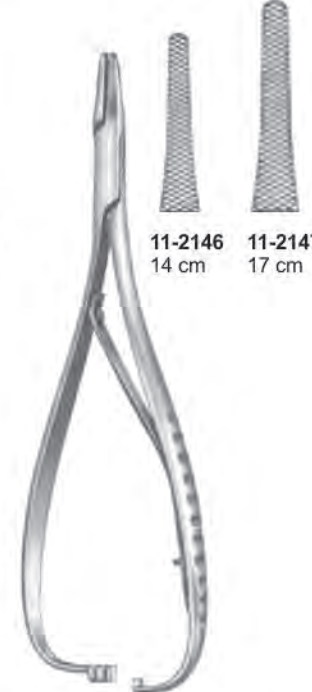

Mathieu
11-2146-11-2147

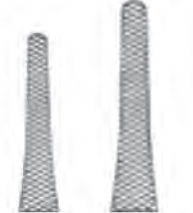

11-2146 14 cm
11-2147 17 cm



Needle Holders, Micro Needle Holders



M.F. ELAHI MEDICAL CO
SERVING WORLDWIDE SURGICAL INSTRUMENTS



Mathieu
11-2148-11-2150



11-2148
17 cm



11-21449
20 cm



11-2150
23 cm



Arruga
11-2151-11-2152



11-2151
13.5 cm



11-2152
13.5 cm



Kalt
11-2153
13.5 cm



Kalt-arruga
11-2154
14 cm



Castroviejo-kalt
11-2155
14 cm



Boynton
11-2156
12 cm



Arruga
11-2157-11-2158
16 cm



11-2157



11-2158



Arruga
11-2159-11-2160
16 cm



11-2159



11-2160



Stevens
11-2161
13 cm, 15 cm



Barraquer
11-2162
14 cm

Needle Holders, Micro Needle Holders



M.F.ELAHI MEDICAL CO
SERVING WORLDWIDE SURGICAL INSTRUMENTS

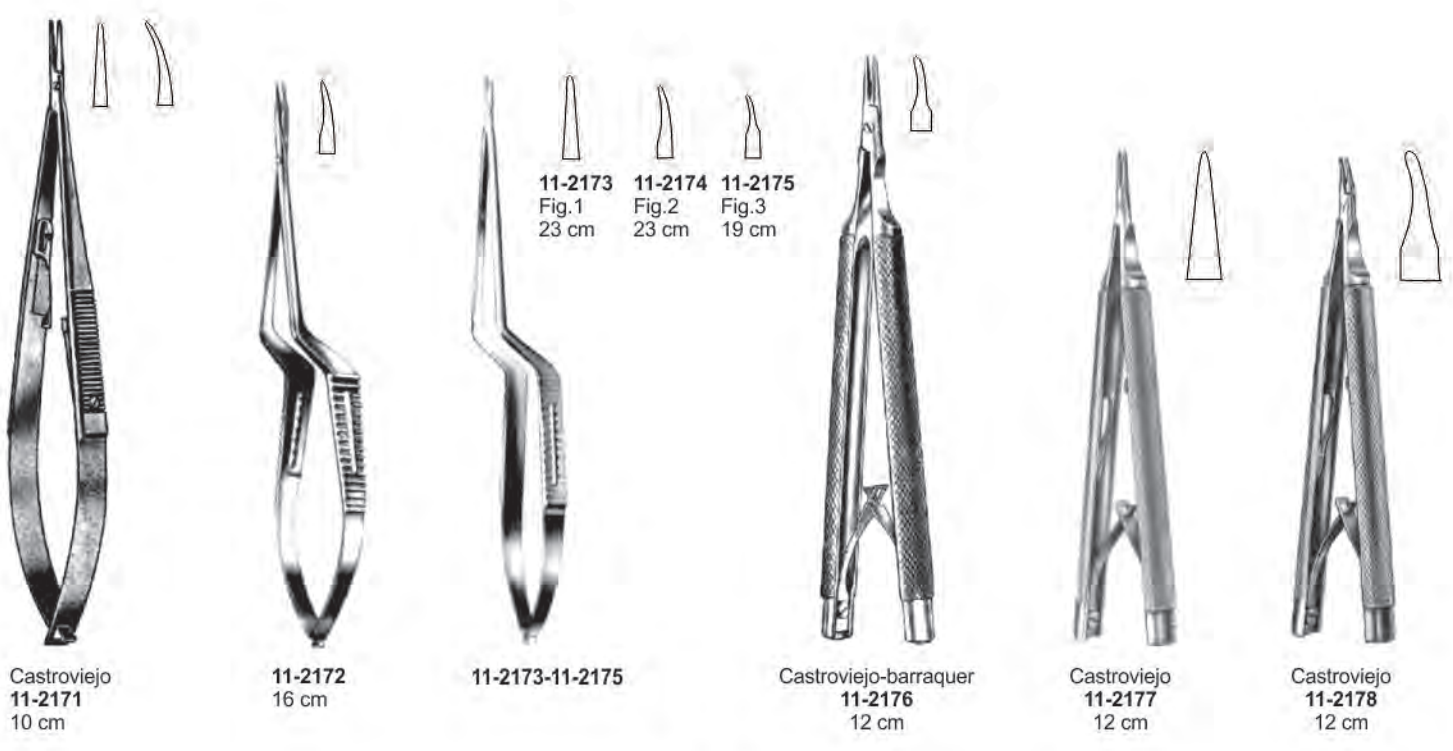
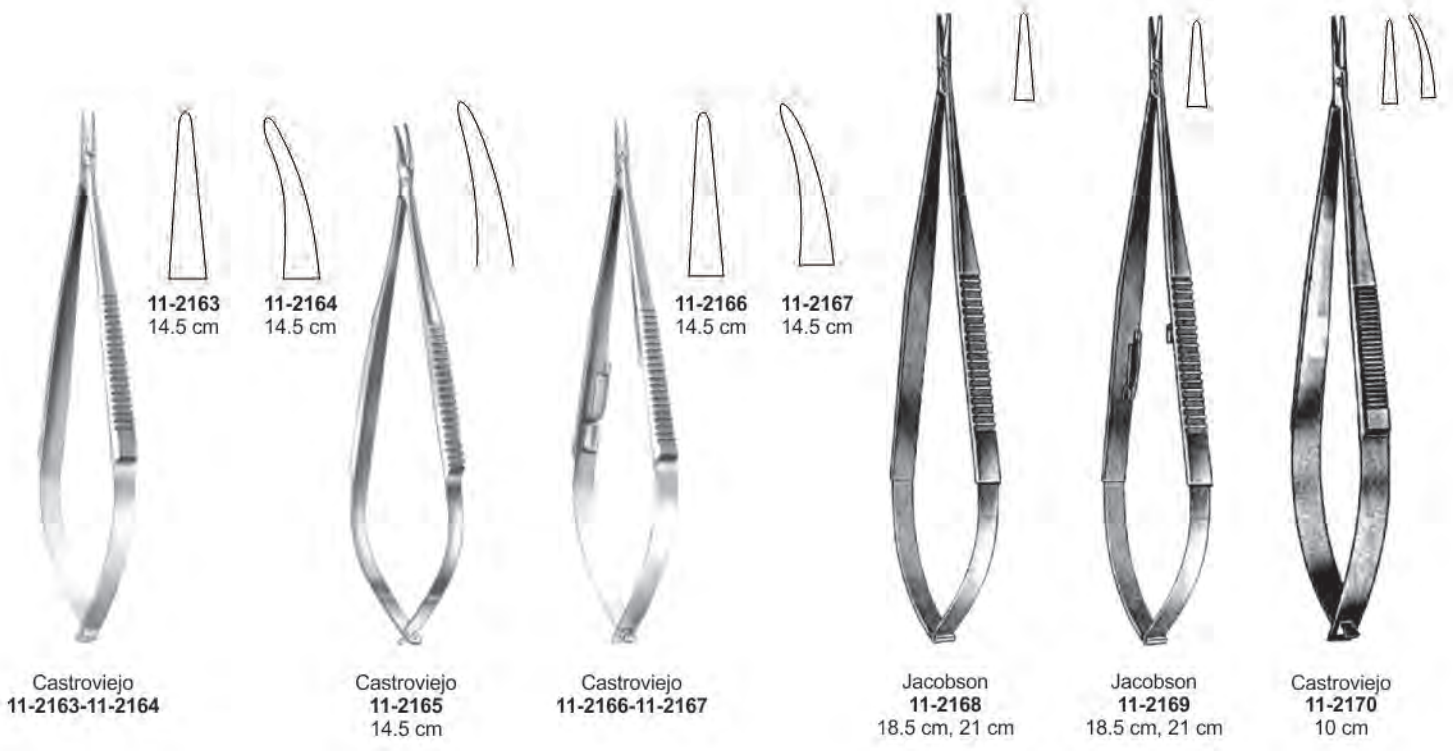

Reverdin Needles, Ligature Needles



M.F.ELAHI MEDICAL CO
SERVING WORLDWIDE SURGICAL INSTRUMENTS

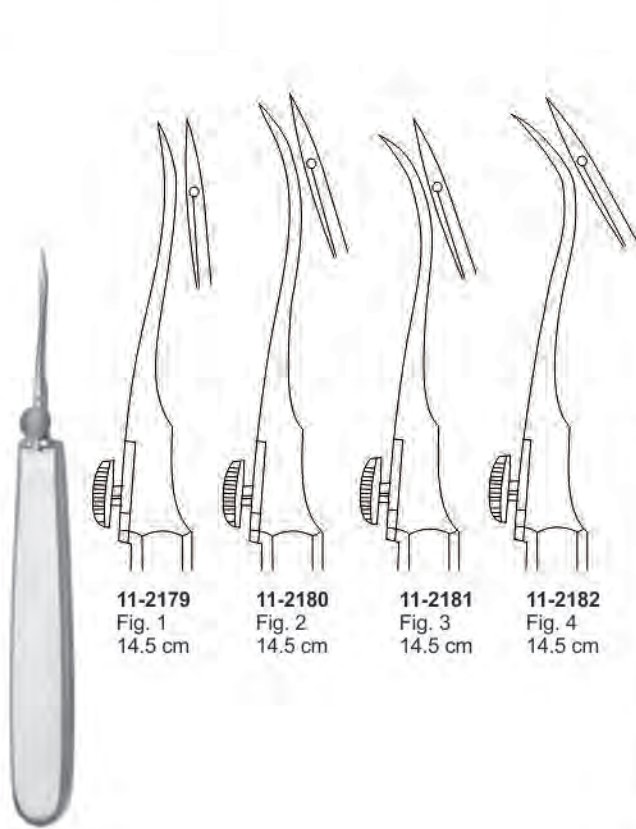

11-2179
Fig. 1
14.5 cm

11-2180
Fig. 2
14.5 cm

11-2181
Fig. 3
14.5 cm

11-2182
Fig. 4
14.5 cm

Reverdin
11-2179-11-2182



11-2183
Fig. 1
20 cm

11-2184
Fig. 2
20 cm

11-2185
Fig. 3
20 cm

11-2186
Fig. 4
20 cm

11-2187
Fig. 1
23 cm

11-2188
Fig. 2
23 cm

11-2189
Fig. 3
23 cm

11-2190
Fig. 4
23 cm

Reverdin
11-2183-11-2186

Reverdin
11-2187-11-2190



Deschamps
11-2191
20 cm

Deschamps
11-2192
20 cm

Deschamps
11-2193
20 cm

Deschamps
11-2194
20 cm

Deschamps
11-2195
24 cm

Deschamps
11-2196
24 cm

Ligature Needles



M.F. ELAHI MEDICAL CO
SERVING WORLDWIDE SURGICAL INSTRUMENTS



Deschamps
11-2197
20 cm

Deschamps
11-2198
20 cm

Deschamps
11-2199
27 cm

Deschamps
11-2200
27 cm

Deschamps
11-2201
27 cm

Deschamps
11-2202
27 cm

Deschamps
11-2203
21 cm

Deschamps
11-2204
21 cm



Deschamps
11-2205
28 cm

Deschamps
11-2206
28 cm

Brunner
11-2207-11-2208
30 cm

11-2206
Fig. 1

11-2207
Fig. 2

11-2207
Fig. 1

11-2208
Fig. 2



Richter
11-2209
14 cm



Collin
11-2210
14 cm



Ligature Needles



M.F. ELAHI MEDICAL CO
SERVING WORLDWIDE SURGICAL INSTRUMENTS



Michel
11-2211
12 cm



Michel
11-2212
12 cm



Wachenfeldt
11-2213
12.5 cm



Wachenfeldt
11-2214
12 cm



Wachenfeldt
11-2215
12 cm



Michel
11-2216
12.5 cm



Cooper
11-2217
20 cm



Kronecker
11-2218
12 cm



Kronecker
11-2219
12 cm



Schmieden-Dick
11-2220
30 cm



Schmieden
11-2221
18 cm



Schmieden-Payr
11-2222
18 cm



König
11-2223-11-2225



11-2223
18 cm
Fig. 1

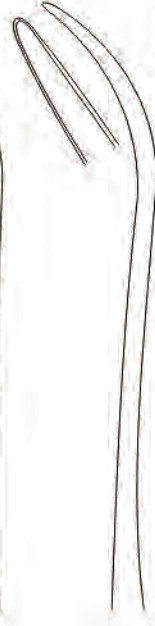

11-2224
18 cm
Fig. 2

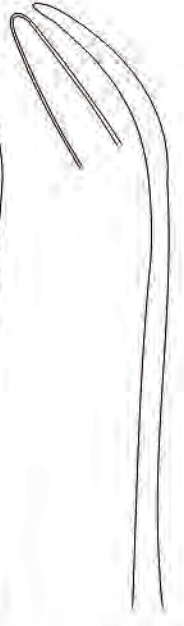

11-2225
18 cm
Fig. 3

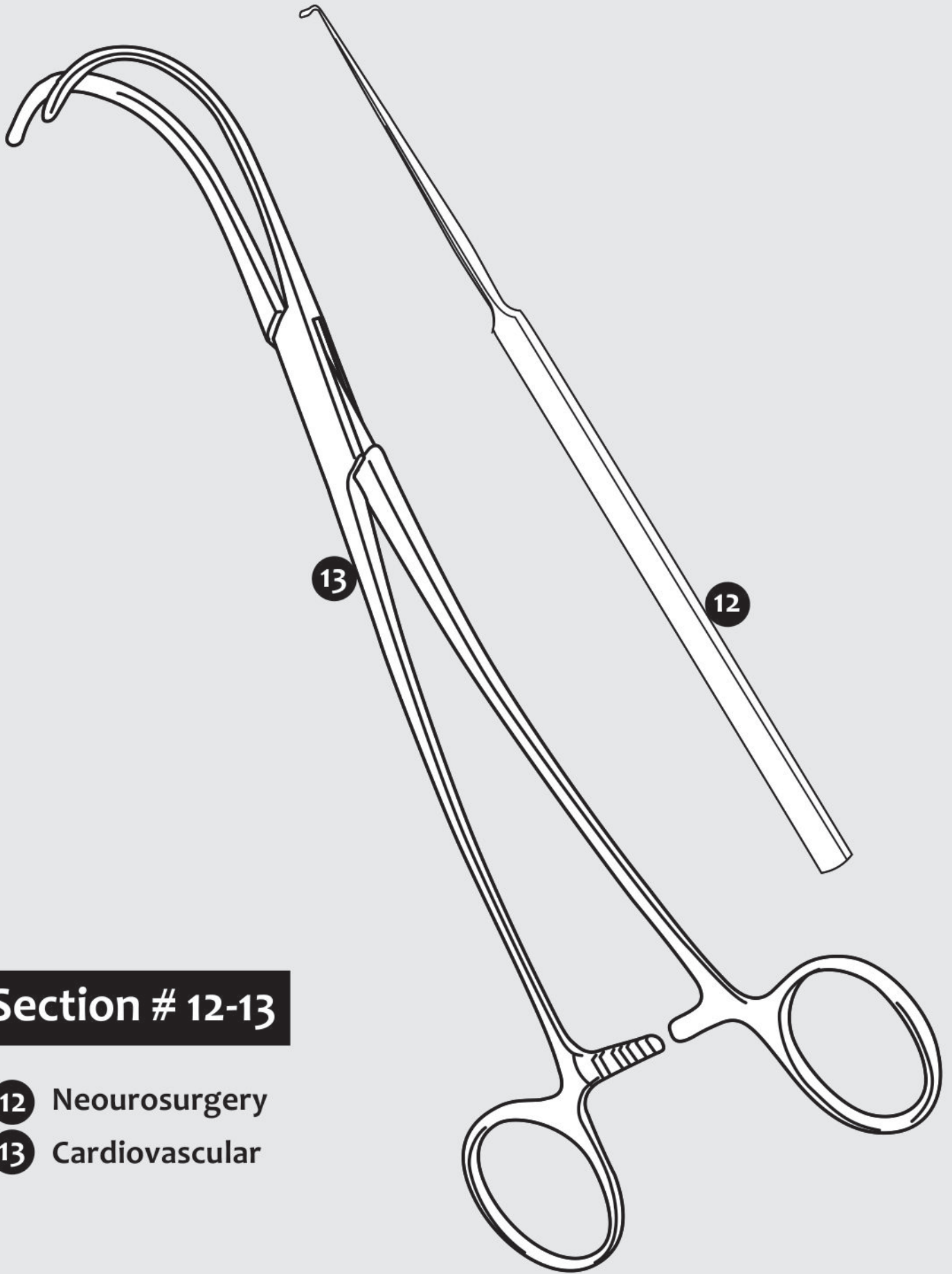

Section # 12-13

- 12** Neurosurgery
- 13** Cardiovascular

Dura Dissectors & Hooks



M.F. ELAHI MEDICAL CO
SERVING WORLDWIDE SURGICAL INSTRUMENTS



12-2300
Frazier
24 cm / 9 4/8"
Ø 3.3 mm



12-2301-12-2308
Frazier

- 12-2301 19,5 cm / 7 5/8" Ø 2,0 mm
- 12-2302 19,5 cm / 7 5/8" Ø 2,3 mm
- 12-2303 19,5 cm / 7 5/8" Ø 2,7 mm
- 12-2304 19,5 cm / 7 5/8" Ø 3,0 mm
- 12-2305 19,5 cm / 7 5/8" Ø 3,3 mm
- 12-2306 19,5 cm / 7 5/8" Ø 3,6 mm
- 12-2307 19,5 cm / 7 5/8" Ø 4,0 mm
- 12-2308 19,5 cm / 7 5/8" Ø 5,0 mm



12-2309
HOEN
15 cm / 5 7/8"



12-2310
HOEN
15 cm / 5 7/8"



12-2311
Sachs
20,5 cm / 8 1/8"



12-2312
Milligan
21,5 cm / 8 4/8"



12-2313
SACHS
21 cm / 8 1/4"



12-2314
WOODSON
22 cm / 8 5/8"



12-2315
WOODSON
25 cm / 9 7/8"



12-2316
Davis
21,5 cm / 8 4/8"



12-2317
Davis
24,5 cm / 9 5/8"



12-2318
21 cm / 8 1/4"

Dura Dissectors ,Nerve Hooks ,
Nerve Root Retractors



M.F.ELAHI MEDICAL CO
SERVING WORLDWIDE SURGICAL INSTRUMENTS



12-2319
FAGER
20 cm / 7 7/8"



12-2320
FAGER
20 cm / 7 7/8"



12-2321
Love
21,5 cm / 8 4/8"
Fig. 1



12-2322
Love
17,5 cm / 6 7/8"
Fig. 2

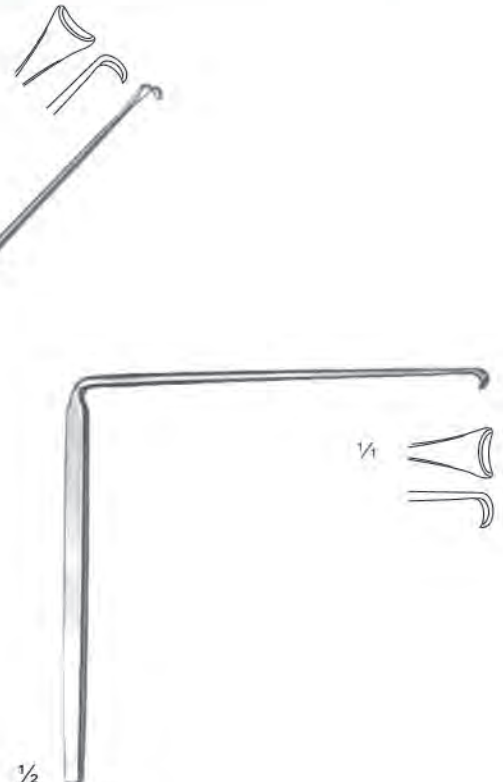

12-2323
Love
11 cm / 4 3/8"
Fig. 3



12-2324
WOODSON
17 cm / 6 3/4"

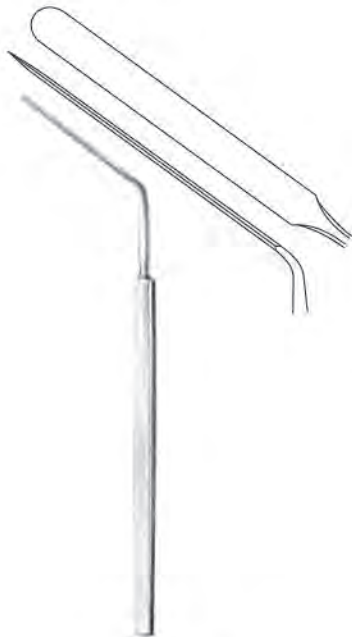

12-2325
HORSLEY
20 cm / 7 7/8"



12-2326
SACHS
21 cm / 8 1/4"



12-2327
16 cm / 6 1/4"



12-2328
Toennis
24 cm / 9 4/8"



Nerve Hooks, Wire Saws



12-2329
Groningen
26,5 cm / 10 3/8"



12-2330
Groningen
26,5 cm / 10 3/8"

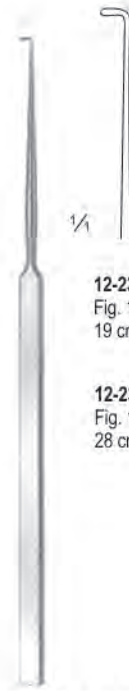

12-2331
Fig. 1
19 cm / 7 4/8"

12-2332
Fig. 1
28 cm / 11"

12-2331-12-2332
Cushing



12-2333
Fig. 2
19 cm / 7 4/8"

12-2334
Fig. 2
28 cm / 11"

12-2333-12-2334
Cushing

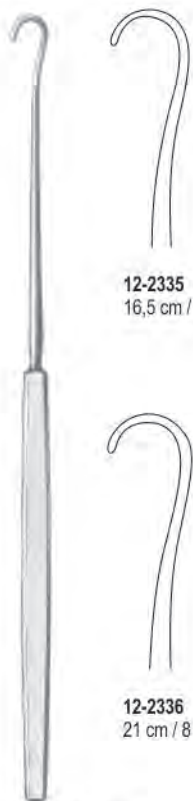

12-2335
16,5 cm / 6 4/8"



12-2336
21 cm / 8 4/8"

12-2335-12-2336
Smithwick



12-2337-12-2341
Gigli Wire Saw

12-2337
30 cm / 11 6/8"

12-2338
40 cm / 15 6/8"

12-2339
50 cm / 19 5/8"

12-2340
60 cm / 23 5/8"

12-2341
70 cm / 27 4/8"



12-2342
Gigli



12-2343
De Martel
33 cm / 13"

Cranial Rongeurs, Applying Forceps,
Lamina Spreaders



M.F. ELAHI MEDICAL CO
SERVING WORLDWIDE SURGICAL INSTRUMENTS



12-2344
Dahlgren
19,5 cm / 7 5/8"



12-2345
De Vibiss
21 cm / 8 2/8"



12-2346
McKenzie
18,5 cm / 7 2/8"



McKENZIE
12-2347 15cm/5"
12-2348 19cm/7 1/2"



12-2349
Raney
15,5 cm / 6"

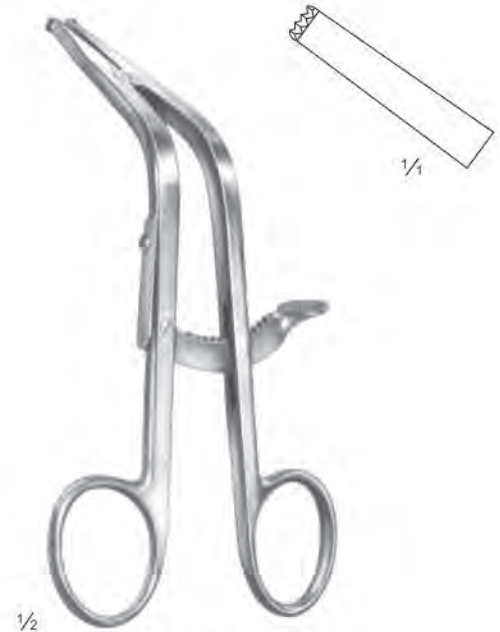

12-2350
Cloward
16 cm / 6 2/8"



Lamina Spreaders, Laminectomy Punches



M.F. ELAHI MEDICAL CO
SERVING WORLDWIDE SURGICAL INSTRUMENTS



12-2351
Inge
16 cm / 6 2/8"



12-2352
De Vibiss
21 cm / 8 2/8"



12-2353
3mm, bite



12-2354
5mm, bite



12-2355
3mm, bite



12-2356
5mm, bite

180 mm

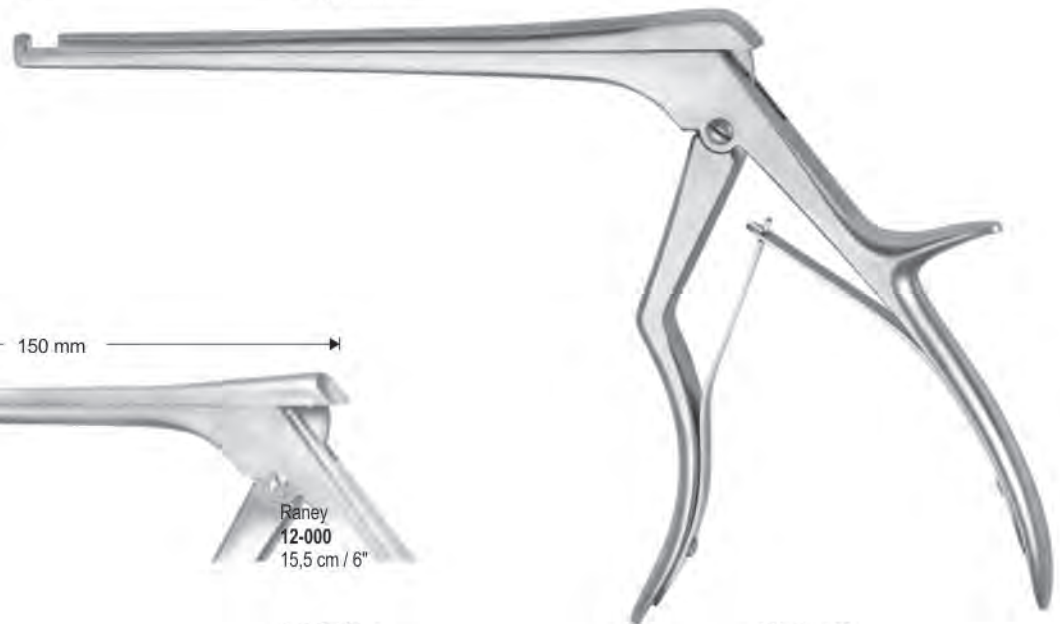

Raney
12-000
15,5 cm / 6"

12-2355-2356
Colclough

12-2353-2354
Colclough

150 mm



Laminectomy Punches

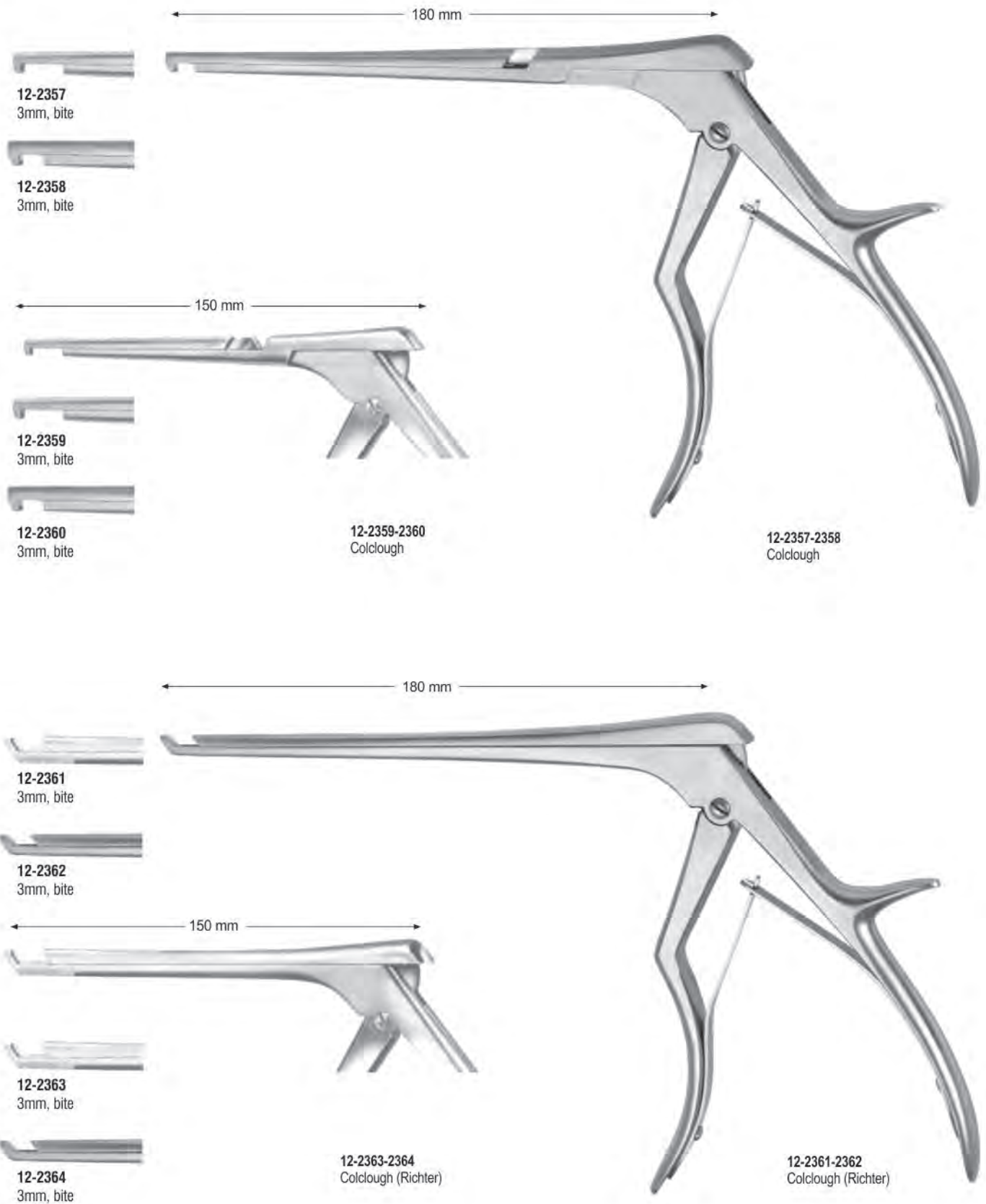



Laminectomy Punches

upwards cutting	12-2365 shaft length 180mm	12-2366 shaft length 230mm
	12-2365A 1mm	12-2366A 1mm
	12-2365B 2mm	12-2366B 2mm
	12-2365C 3mm	12-2366C 3mm
	12-2365D 4mm	12-2366D 4mm
	12-2365E 5mm	12-2366E 5mm
	12-2365F 6mm	12-2366F 6mm

40° upwards cutting	12-2367 shaft length 180mm	12-2368 shaft length 230mm
	12-2367A 1mm	12-2368A 1mm
	12-2367B 2mm	12-2368B 2mm
	12-2367C 3mm	12-2368C 3mm
	12-2367D 4mm	12-2368D 4mm
	12-2367E 5mm	12-2368E 5mm
	12-2367F 6mm	12-2368F 6mm



12-2365-2368
Ferris-Smith Kerrison

upwards cutting	12-2369 shaft length 180mm	12-2370 shaft length 230mm	upwards cutting	12-2371 shaft length 180mm	12-2372 shaft length 230mm
	12-2369A 1mm	12-2370A 1mm		12-2371A 1mm	12-2372A 1mm
	12-2369B 2mm	12-2370B 2mm		12-2371B 2mm	12-2372B 2mm
	12-2369C 3mm	12-2370C 3mm		12-2371C 3mm	12-2372C 3mm
	12-2369D 4mm	12-2370D 4mm		12-2371D 4mm	12-2372D 4mm
	12-2369E 5mm	12-2370E 5mm		12-2371E 5mm	12-2372E 5mm
	12-2369F 6mm	12-2370F 6mm		12-2371F 6mm	12-2372F 6mm

40° upwards cutting	12-2373 shaft length 180mm	12-2374 shaft length 230mm
	12-2373A 1mm	12-2374A 1mm
	12-2373B 2mm	12-2374B 2mm
	12-2373C 3mm	12-2374C 3mm
	12-2373D 4mm	12-2374D 4mm
	12-2373E 5mm	12-2374E 5mm
	12-2373F 6mm	12-2374F 6mm

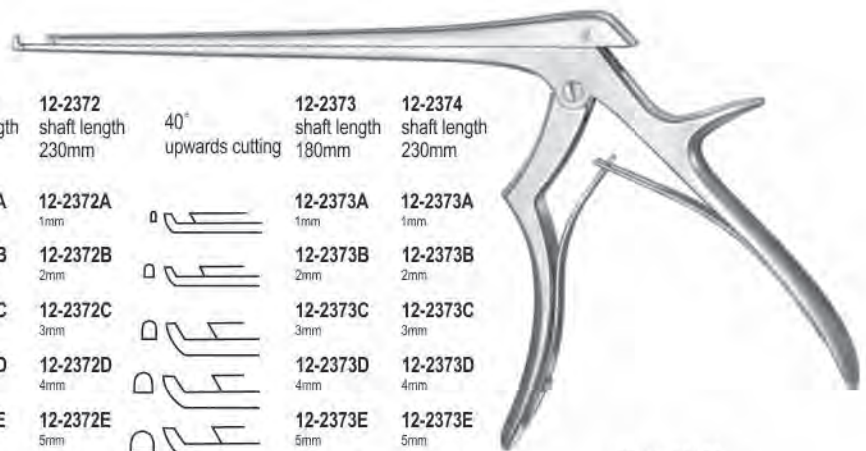

12-2369-2374
Ferris-Smith Kerrison

12-2375
Ø 2.2 mm

12-2376
Ø 3.5 mm



12-2375-12-2376
YASARGIL

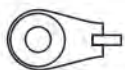

12-2377
Ø 9.0 mm

12-2377
LANDOLT
Tumor grasping forceps,
blunt

Laminectomy Punches, Rongeurs



M.F. ELAHI MEDICAL CO
SERVING WORLDWIDE SURGICAL INSTRUMENTS



12-2378
Ø 7.0 mm

12-2378
OLDBERG



12-2379
25 cm / 9 3/4"
Ø 8,0 mm

1/2
12-2379
Shaft Length

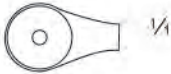
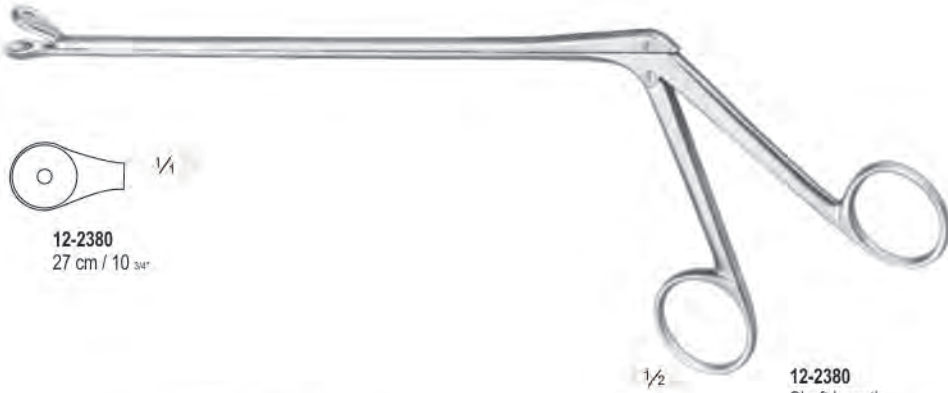

12-2380
27 cm / 10 3/4"

1/2
12-2380
Shaft Length



12-2381
25,5 cm / 10"

1/2
12-2381
Shaft Length



Rongeurs



12-2382- Shaft 12.5 cm
12-2382- Shaft 14 cm
12-2382- Shaft 16 cm
12-2382- Shaft 18.5 cm
2 x 10mm



12-2385- Shaft 12.5 cm
12-2385- Shaft 14 cm
12-2385- Shaft 16 cm
12-2385- Shaft 18.5 cm
3 x 10mm



12-2388- Shaft 12.5 cm
12-2388- Shaft 14 cm
12-2388- Shaft 16 cm
12-2388- Shaft 18.5 cm
4 x 10mm



12-2391- Shaft 12.5 cm
12-2391- Shaft 14 cm
12-2391- Shaft 16 cm
12-2391- Shaft 18.5 cm
5 x 10mm



12-2383- Shaft 12.5 cm
12-2383- Shaft 14 cm
12-2383- Shaft 16 cm
12-2383- Shaft 18.5 cm
2 x 10mm



12-2386- Shaft 12.5 cm
12-2386- Shaft 14 cm
12-2386- Shaft 16 cm
12-2386- Shaft 18.5 cm
3 x 10mm



12-2389- Shaft 12.5 cm
12-2389- Shaft 14 cm
12-2389- Shaft 16 cm
12-2389- Shaft 18.5 cm
4 x 10mm



12-2392- Shaft 12.5 cm
12-2392- Shaft 14 cm
12-2392- Shaft 16 cm
12-2392- Shaft 18.5 cm
5 x 10mm



12-2384- Shaft 12.5 cm
12-2384- Shaft 14 cm
12-2384- Shaft 16 cm
12-2384- Shaft 18.5 cm
2 x 10mm



12-2387- Shaft 12.5 cm
12-2387- Shaft 14 cm
12-2387- Shaft 16 cm
12-2387- Shaft 18.5 cm
3 x 10mm



12-2390- Shaft 12.5 cm
12-2390- Shaft 14 cm
12-2390- Shaft 16 cm
12-2390- Shaft 18.5 cm
4 x 10mm



12-2393- Shaft 12.5 cm
12-2393- Shaft 14 cm
12-2393- Shaft 16 cm
12-2393- Shaft 18.5 cm
5 x 10mm

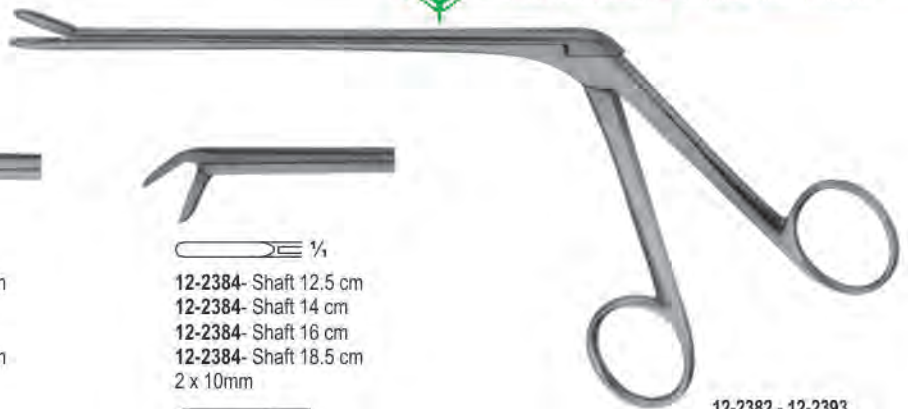

12-2382 - 12-2393
CASPAR

12-2382 - 2384



2 mm

12-2385 - 2387



3 mm

12-2388 - 2390



4 mm

12-2391 - 2393



5 mm

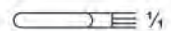

CUSHING
12-2394- Shaft 12 cm
12-2394- Shaft 15 cm
12-2394- Shaft 16 cm
12-2394- Shaft 18 cm
2 x 10mm

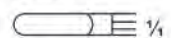

LOVE-GRUENWALD
12-2397- Shaft 12 cm
12-2397- Shaft 15 cm
12-2397- Shaft 16 cm
12-2397- Shaft 18 cm
3 x 10mm

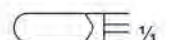

SPURING
12-2400- Shaft 12 cm
12-2400- Shaft 15 cm
12-2400- Shaft 16 cm
12-2400- Shaft 18 cm
4 x 10mm



CUSHING
12-2395- Shaft 12 cm
12-2395- Shaft 15 cm
12-2395- Shaft 16 cm
12-2395- Shaft 18 cm
2 x 10mm



LOVE-GRUENWALD
12-2398- Shaft 12 cm
12-2398- Shaft 15 cm
12-2398- Shaft 16 cm
12-2398- Shaft 18 cm
3 x 10mm



SPURING
12-2401- Shaft 12 cm
12-2401- Shaft 15 cm
12-2401- Shaft 16 cm
12-2401- Shaft 18 cm
4 x 10mm



CUSHING
12-2396- Shaft 12 cm
12-2396- Shaft 15 cm
12-2396- Shaft 16 cm
12-2396- Shaft 18 cm
2 x 10mm



LOVE-GRUENWALD
12-2399- Shaft 12 cm
12-2399- Shaft 15 cm
12-2399- Shaft 16 cm
12-2399- Shaft 18 cm
3 x 10mm



SPURING
12-2402- Shaft 12 cm
12-2402- Shaft 15 cm
12-2402- Shaft 16 cm
12-2402- Shaft 18 cm
4 x 10mm

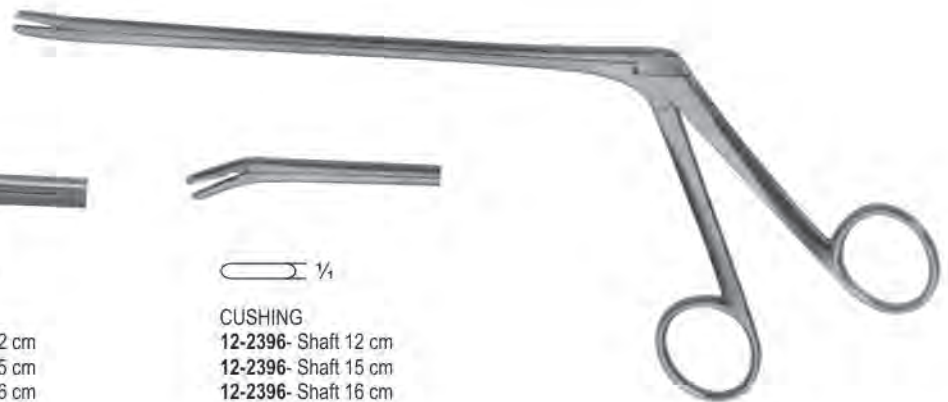

12-2394 - 12-2402
CASPAR





Rongeurs



12-2403 - 12-2417
CASPAR



12-2403- Shaft 12.5 cm
12-2403- Shaft 14 cm
12-2403- Shaft 16 cm
12-2403- Shaft 18.5 cm
2 x 12mm Size of Jaws



12-2404- Shaft 12.5 cm
12-2404- Shaft 14 cm
12-2404- Shaft 16 cm
12-2404- Shaft 18.5 cm
3 x 12mm Size of Jaws



12-2405- Shaft 12.5 cm
12-2405- Shaft 14 cm
12-2405- Shaft 16 cm
12-2405- Shaft 18.5 cm
4 x 12mm Size of Jaws



12-2406- Shaft 12.5 cm
12-2406- Shaft 14 cm
12-2406- Shaft 16 cm
12-2406- Shaft 18.5 cm
3 x 12mm Size of Jaws



12-2407- Shaft 12.5 cm
12-2407- Shaft 14 cm
12-2407- Shaft 16 cm
12-2407- Shaft 18.5 cm
4 x 12mm Size of Jaws



12-2408- Shaft 12.5 cm
12-2408- Shaft 14 cm
12-2408- Shaft 16 cm
12-2408- Shaft 18.5 cm
5 x 12mm Size of Jaws



12-2409- Shaft 12.5 cm
12-2409- Shaft 14 cm
12-2409- Shaft 16 cm
12-2409- Shaft 18.5 cm
4 x 12mm Size of Jaws



12-2410- Shaft 12.5 cm
12-2410- Shaft 14 cm
12-2410- Shaft 16 cm
12-2410- Shaft 18.5 cm
5 x 12mm Size of Jaws



12-2411- Shaft 12.5 cm
12-2411- Shaft 14 cm
12-2411- Shaft 16 cm
12-2411- Shaft 18.5 cm
6 x 12mm Size of Jaws



12-2412- Shaft 12.5 cm
12-2412- Shaft 14 cm
12-2412- Shaft 16 cm
12-2412- Shaft 18.5 cm
5 x 12mm Size of Jaws



12-2413- Shaft 12.5 cm
12-2413- Shaft 14 cm
12-2413- Shaft 16 cm
12-2413- Shaft 18.5 cm
6 x 12mm Size of Jaws



12-2414- Shaft 12.5 cm
12-2414- Shaft 14 cm
12-2414- Shaft 16 cm
12-2414- Shaft 18.5 cm
6 x 12mm Size of Jaws



12-2415- Shaft 12.5 cm
12-2415- Shaft 14 cm
12-2415- Shaft 16 cm
12-2415- Shaft 18.5 cm
6 x 12mm Size of Jaws



12-2416- Shaft 12.5 cm
12-2416- Shaft 14 cm
12-2416- Shaft 16 cm
12-2416- Shaft 18.5 cm
6 x 12mm Size of Jaws



12-2417- Shaft 12.5 cm
12-2417- Shaft 14 cm
12-2417- Shaft 16 cm
12-2417- Shaft 18.5 cm
6 x 12mm Size of Jaws



Rib Shears, Sternum Chisel



M.F.ELAHI MEDICAL CO
SERVING WORLDWIDE SURGICAL INSTRUMENTS



Bone Shears
13-2400
23 cm



13-2401
23 cm



Gluck
13-2402
21 cm



Brunner
13-2403
32 cm



Giertz-Stille
13-2404
24.5 cm



Sauerbruch
13-2405
26 cm



Bethune
13-2406
34.5 cm



Lebsche
13-2407
24.5 cm





Rib Retractors



13-2408 with 2 pairs of blades spreading
for babies (9x20) (9x10) (52 mm)



13-2409 for babies lateral blades spreading
Cooley (12x16) (95 mm)



13-2410 for children lateral blades spreading
Cooley (15x30) (21x44) (140 mm) (150 mm)



13-2411 for adults lateral blades spreading
Cooley (35x50) (200 mm)



13-2412 for babies lateral blades spreading
Finocchio, Infant (15x15) (75 mm)



13-2413 for children lateral blades spreading
Finocchio, Baby (31x31) (100 mm)





Rib Retractors, Sternal Retractors



13-2414 lateral blades spreading
Finochietto (40x45)(52x62)(85x65) (135 mm) (175 mm)



13-2415 with 2 pairs of blades spreading
Burford (47x62) + (65x62) (200 mm)
(47x62) + (65x62) (260 mm)



13-2416 for babies lateral blades spreading
Castañeda (10.5x32) (65 mm)



13-2417 for infants lateral blades spreading
Castañeda (12x45) (70 mm)



13-2418 for infants lateral blades spreading
Castañeda (15x60) (120 mm)



13-2419 lateral blades spreading
Finochietto (modif.) (14x15) (120 mm)





Rib Retractors,



13-2420 lateral blades spreading
Haigh (30x30) (120 mm)

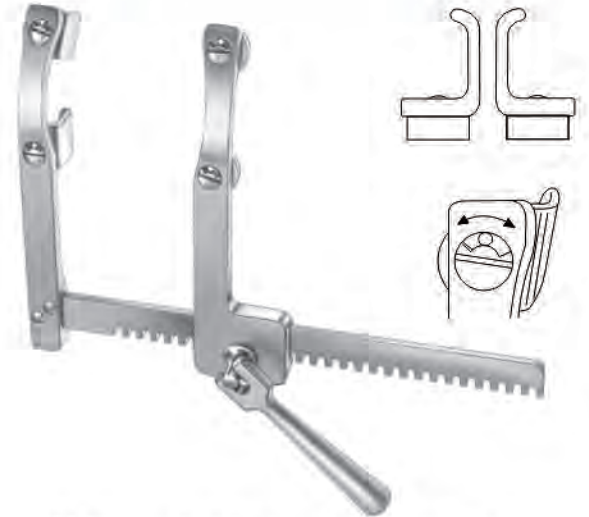

13-2421 for children 4 movable blades spreading
Morse-Favaloro (17x22) (160 mm)



13-2422 for adults 4 movable blades spreading
Morse (22x27) (200 mm)



13-2423 lateral blades spreading
Tuffier (45x45) (160 mm)

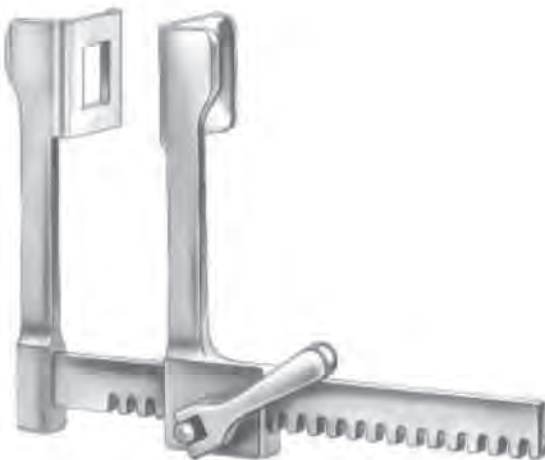

13-2424 lateral blades spreading
Finochietto, Baby (14x15) (75 mm)



13-2425 lateral blades spreading
Finochietto (30x45) (46x62) (150 mm) (190 mm) (80x65)





Rib Retractors, Thoracic Retractor



13-2426 with 3 pairs of blades spreading (150 mm)
De Bakey (30x30) (40x40)

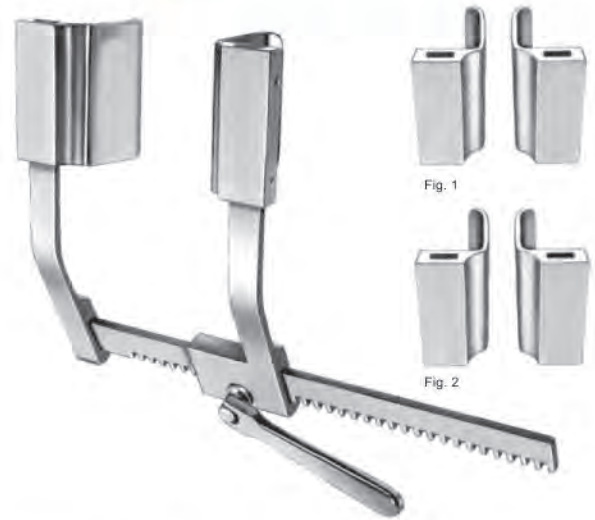

13-2427 with 3 pairs of blades spreading (200 mm)
De Bakey (60x60) (50x80) (40x100)



13-2428 with 1 pair of blades each
(Mercedes Retractor)



Fig 1



Fig 2

Lateral Blades Pair (48x68) (70x75)
Fig 1
Fig 2

Rib Contractors, Lung Spatulas,
Bronchus Clamps



M.F. ELAHI MEDICAL CO
SERVING WORLDWIDE SURGICAL INSTRUMENTS



13-2429
Sellers
20 cm / 7 7/8"



13-2430
Bailey-Baby
15.5 cm / 6 1/8"



13-2431
Bailey
20 cm / 7 7/8"



13-2432
Bailey-Gibbon
20 cm / 7 7/8"



13-2433
Allison
29.5 cm



13-2434

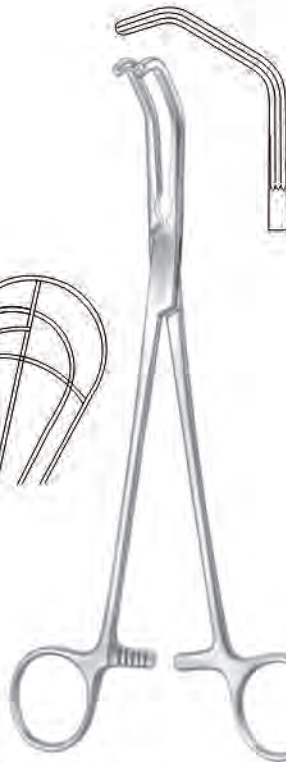
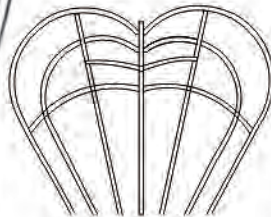

13-2435
Price-Thomas
22 cm / 8 5/8"

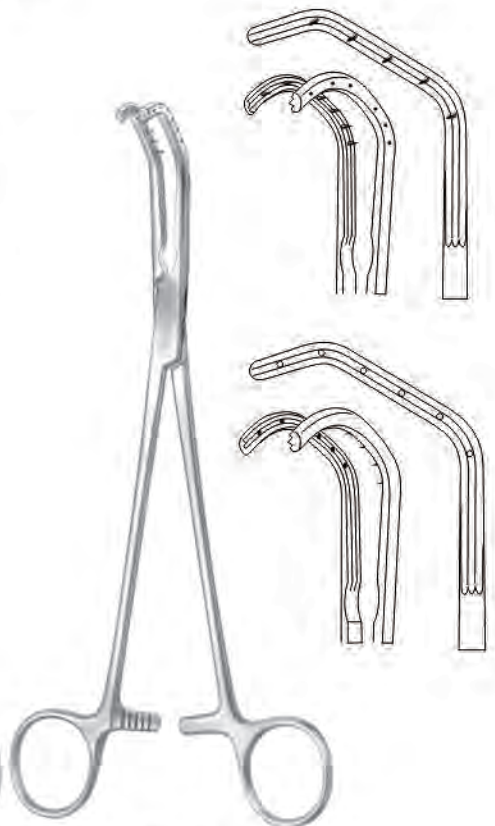

13-2436
Price-Thomas
22 cm / 8 5/8"



Bronchus Clamps, Lung Grasping Forceps, Bulldog Clamps



M.F. ELAHI MEDICAL CO
SERVING WORLDWIDE SURGICAL INSTRUMENTS

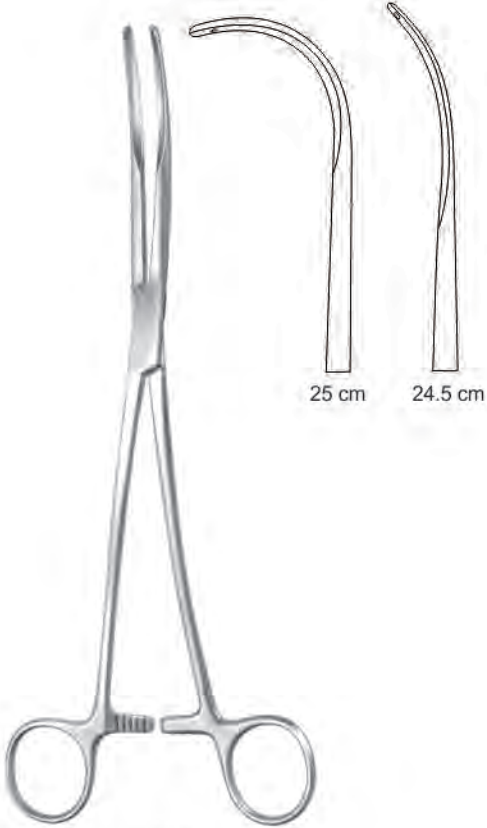

13-2437
Semb



13-2438
Lovelace
20,5 cm / 8 1/8"

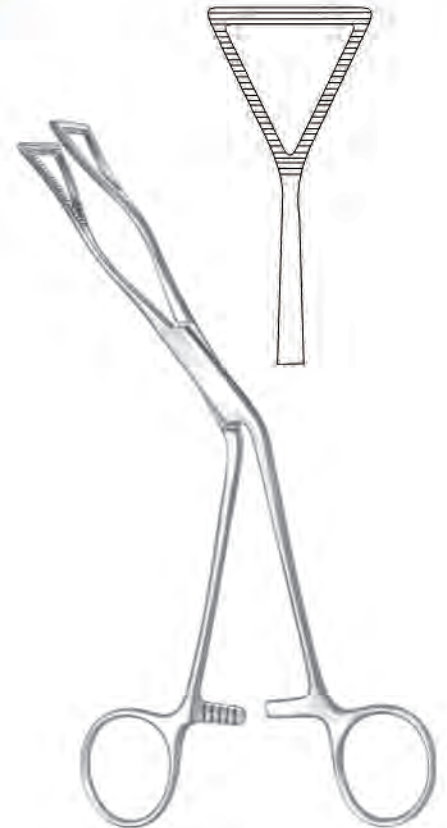

13-2439
Lovelace
19 cm / 7 4/8"



13-2440
De Bakey-Satinsky
7 cm / 2 6/8"

13-2441
De Bakey-Satinsky
9 cm / 3 4/8"

13-2442
De Bakey-Satinsky
10 cm / 3 7/8"

13-2443
Glover
6,5 cm / 2 4/8"

13-2444
Santulli
7 cm / 2 6/8"



Bronchus Clamps, Lung Grasping Forceps, Bulldog Clamps, Aortic Clamps



M.F. ELAHI MEDICAL CO
SERVING WORLDWIDE SURGICAL INSTRUMENTS

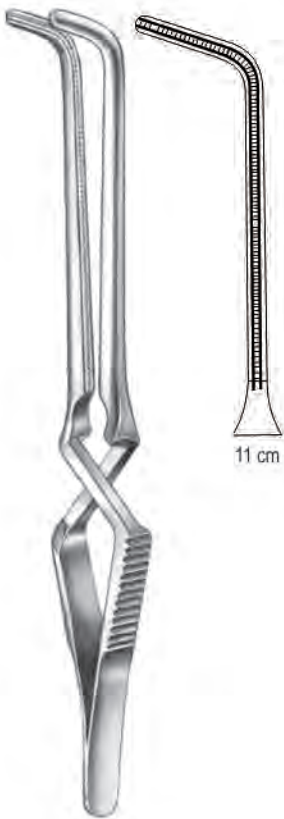

13-2445
Gregory, soft
Carotid clamp



13-2446
Gregory
Carotid clamp

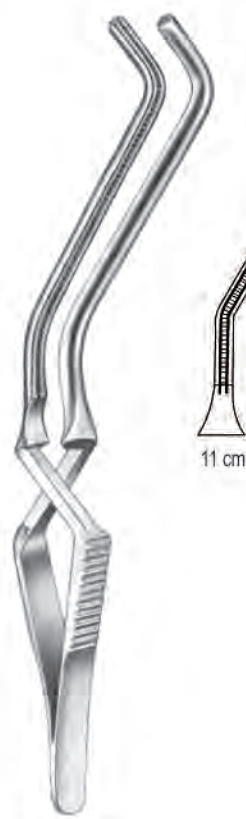

13-2447
De Bakey-Rankin
16 cm

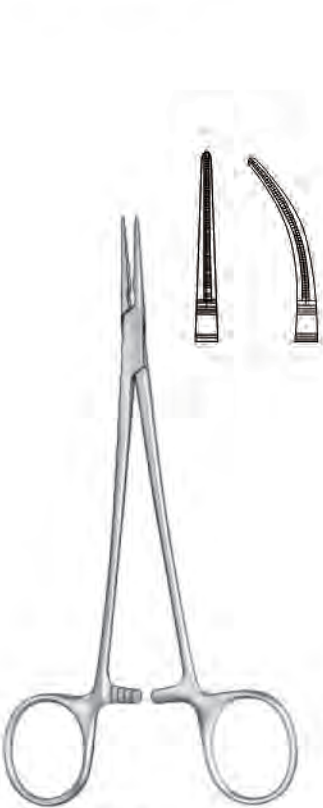

13-2448
De Bakey-Mosquito
15 cm



13-2449
Ochsner
22 cm / 8 5/8"



13-2450
Diethrich
22 cm / 8 5/8"

Multi purpose Vascular Clamps,
Peripheral Vascular Clamps



M.F. ELAHI MEDICAL CO
SERVING WORLDWIDE SURGICAL INSTRUMENTS



13-2451-13-2460
Dardik



13-2451
15 cm / 5 7/8"



13-2452
15,5 cm / 6 1/8"
15°



13-2453
15,5 cm / 6 1/8"
30°

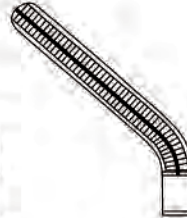

13-2454
15 cm / 5 7/8"
45°



13-2455
13,5 cm / 5 3/8"
90°



13-2456
17 cm / 6 5/8"



13-2457
16,5 cm / 6 4/8"
15°

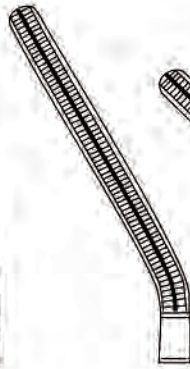

13-2458
16,5 cm / 6 4/8"
30°

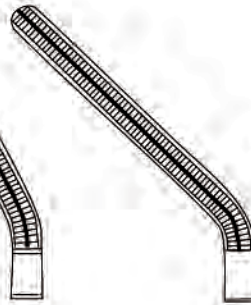

13-2459
17 cm / 6 5/8"
45°

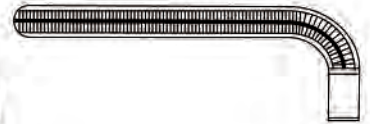

13-2460
13,5 cm / 5 3/8"
90°



13-2461
Dale
18 cm / 7 1/8"

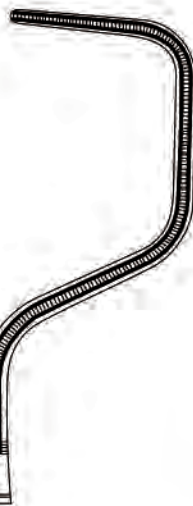

13-2462
17,5 cm / 6 7/8"

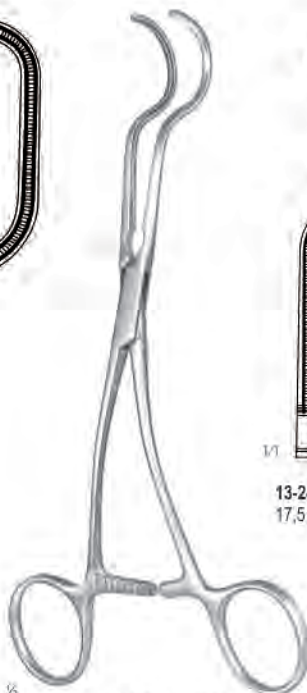

13-2462-13-2464
Dale



13-2463
18 cm / 7 1/8"



13-2464
18,5 cm / 7 2/8"

Profunda Clamps, Carotid Shunt Clamps



M.F. ELAHI MEDICAL CO
SERVING WORLDWIDE SURGICAL INSTRUMENTS



1/2

13-2465-13-2467
Gregory

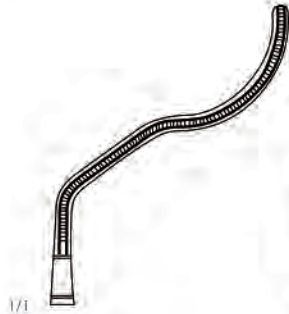

1/1

13-2465
13,5 cm / 5 3/8"



13-2466
16 cm / 6 2/8"



13-2467
18 cm / 7 1/8"

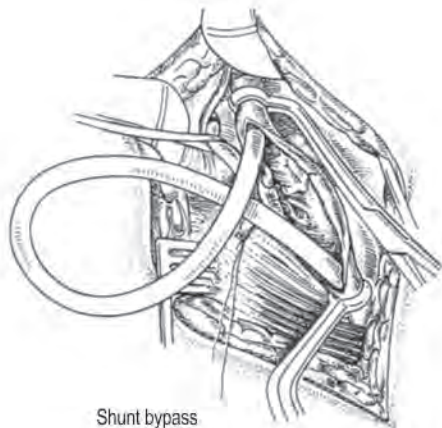

Shunt bypass



1/2

13-2468
Javid
17.5 cm

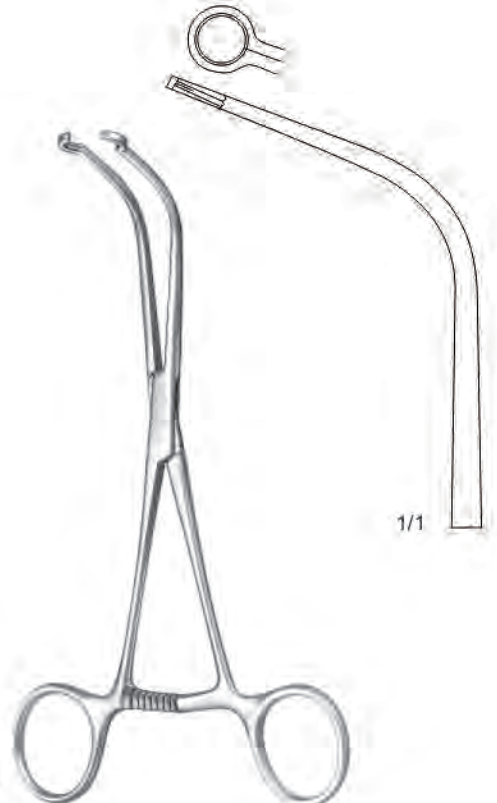

1/2

13-2469
Javid
18.5 cm



Aortic Clamps, Vascular Forceps



M.F. ELAHI MEDICAL CO
SERVING WORLDWIDE SURGICAL INSTRUMENTS



13-2470
De Bakey
30 cm



13-2471-13-2474
De Bakey
2,7 mm



13-2475-13-2477
De Bakey
1,5 mm



13-2478-13-2481
De Bakey
2,0 mm

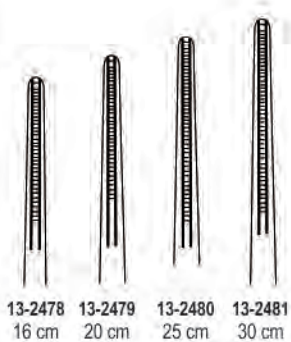

13-2482-13-2485
De Bakey
2,0 mm



13-2486-13-2489
De Bakey
3,5 mm

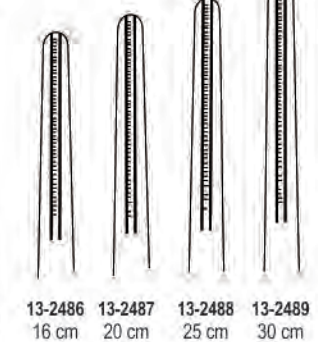



Bulldog Clamps, Coarctation Clamps

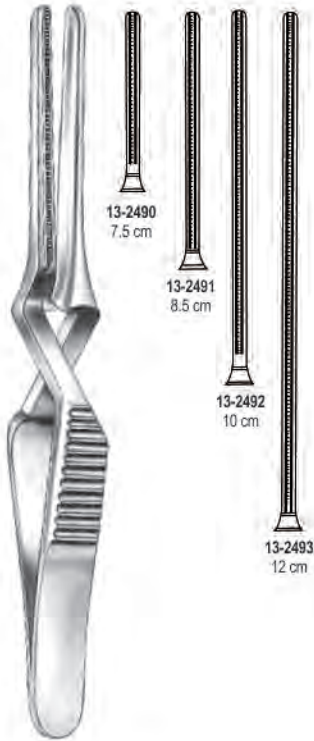

13-2490-13-2493
De Bakey



13-2494-13-2497
De Bakey

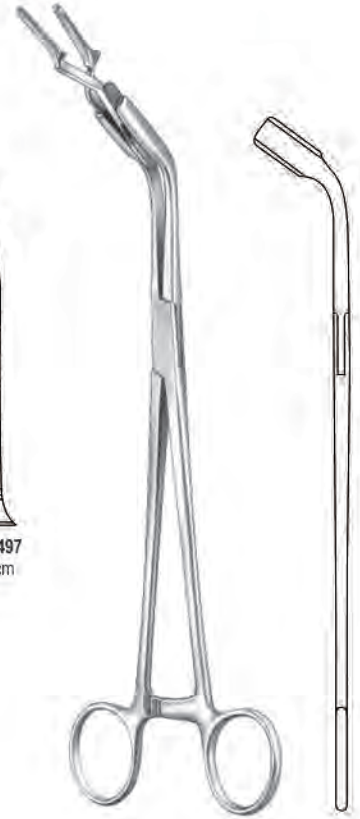

13-2498
Applying Forceps for
Bulldog clamps (24 cm)

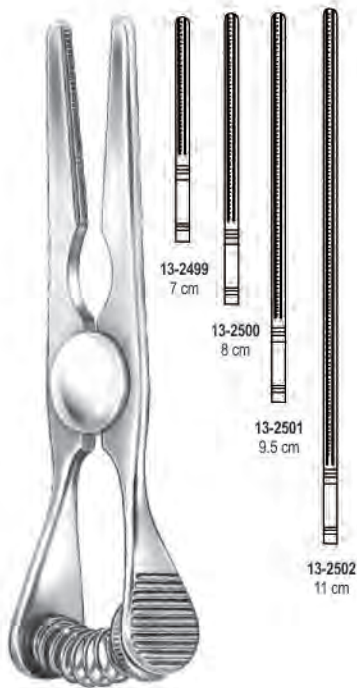

13-2499
Glover

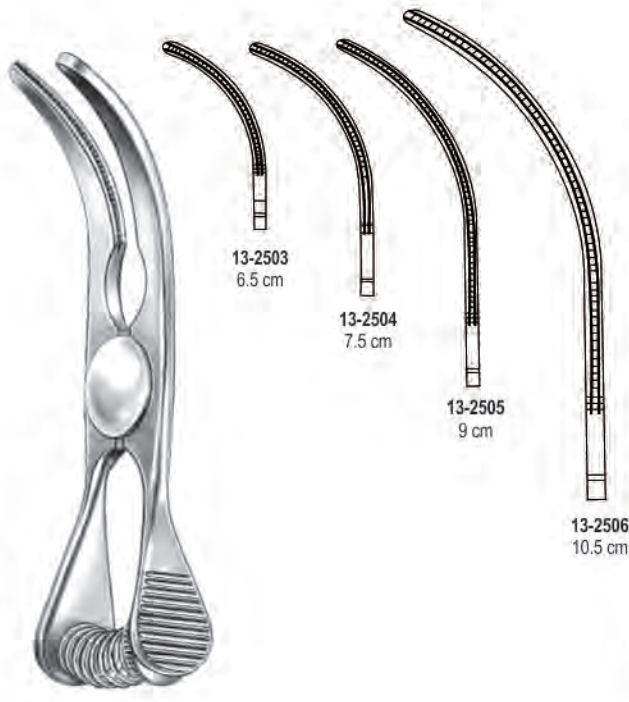

13-2503-13-2506
Glover

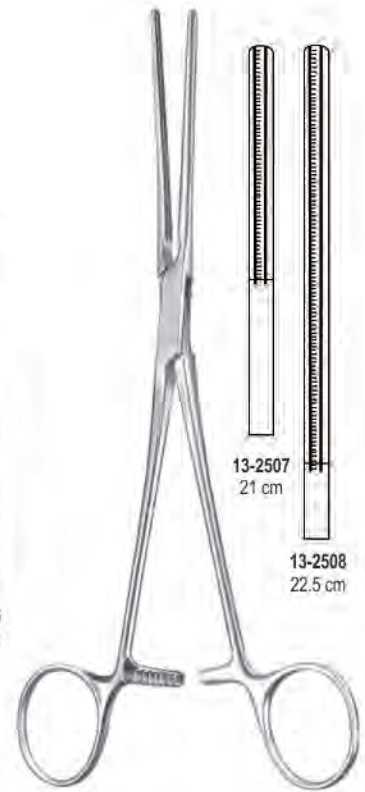

13-2507-13-2508
Potts

Coarctation Clamps, Anastomosis Clamps,
Ligature Forceps, Peripheral Vascular Clamps



M.F. ELAHI MEDICAL CO
SERVING WORLDWIDE SURGICAL INSTRUMENTS

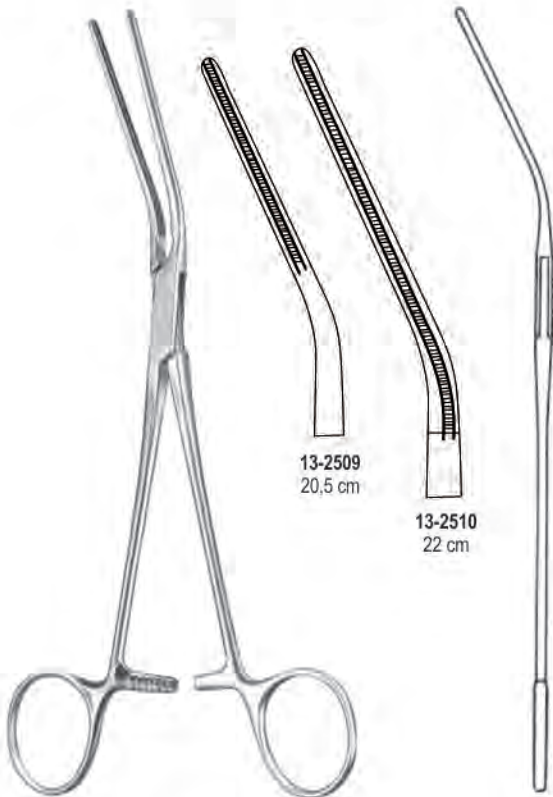

13-2509
20,5 cm

13-2510
22 cm

13-2509-13-2510
Potts

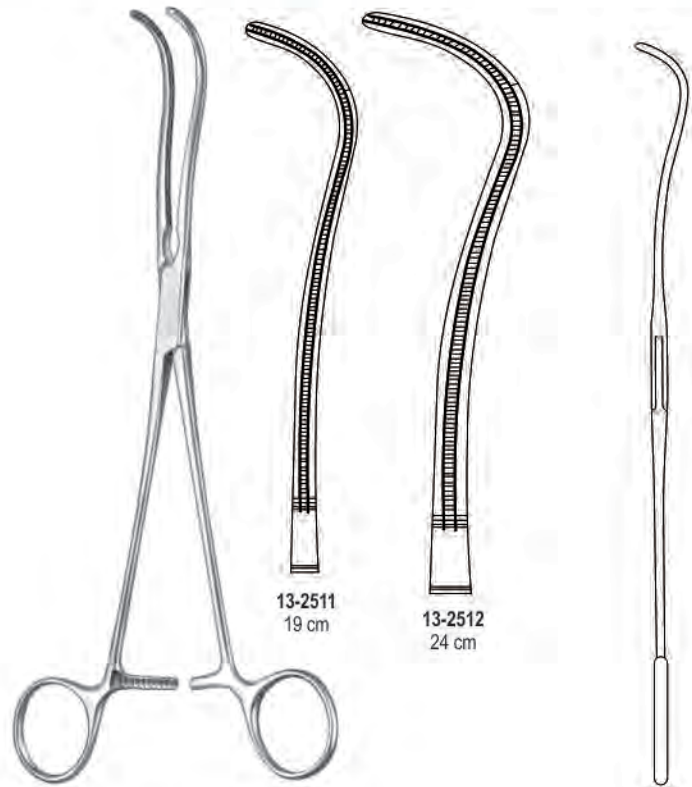

13-2511
19 cm

13-2512
24 cm

13-2511-13-2512
De Bakey
Dissecting and Ligature Forceps



13-2513
De Bakey
16 cm



13-2514
De Bakey
19 cm

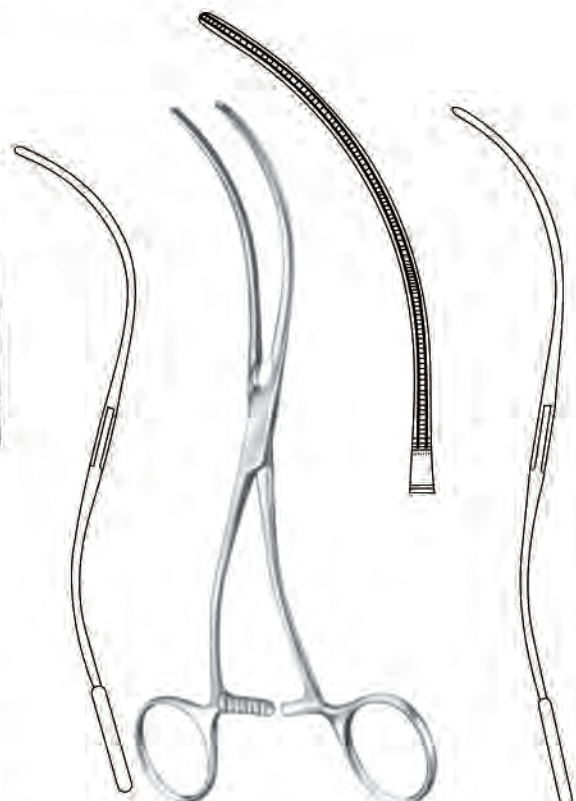

13-2515
De Bakey
20 cm





Peripheral Vascular Clamps, Multi purpose
Vascular Clamps



13-2516-13-2518
Leland-Jones

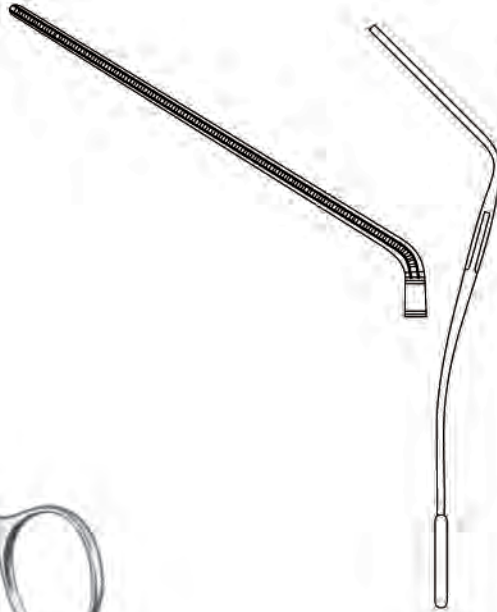

13-2516
18 cm

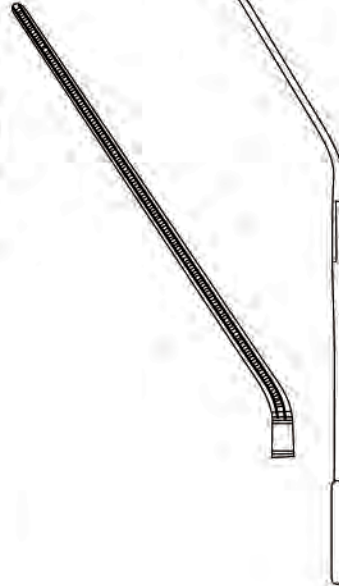

13-2517
19 cm



13-2518
20 cm



13-2519-13-2520
Bainbridge



13-2519
15 cm



13-2520
18.5 cm



13-2521-13-2522
Bainbridge



13-2521
15 cm



13-2522
18.5 cm



Multi purpose Vascular Clamps, Aortic
Aneurysm Clamps, Aortic Ligature Forceps



M.F. ELAHI MEDICAL CO
SERVING WORLDWIDE SURGICAL INSTRUMENTS



13-2523
De Bakey
20 cm



13-2524
De Bakey
28 cm



13-2525
De Bakey
30 cm



13-2526-13-2529
De Bakey

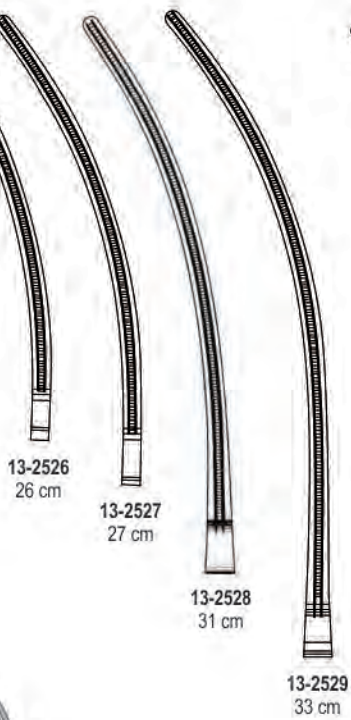

13-2526
26 cm

13-2527
27 cm

13-2528
31 cm

13-2529
33 cm



13-2530
Cooley
25 cm



Ligature Forceps, Aortic Clamps,
Ligature Forceps



M.F. ELAHI MEDICAL CO
SERVING WORLDWIDE SURGICAL INSTRUMENTS



13-2531
De Bakey
24,5 cm



13-2532
De Bakey
24,5 cm



13-2533
De Bakey
27 cm



13-2534
De Bakey
27 cm



Aortic Clamps, Forceps for kidney and pancreas



M.F. ELAHI MEDICAL CO
SERVING WORLDWIDE SURGICAL INSTRUMENTS



13-2535
Weber
24 cm

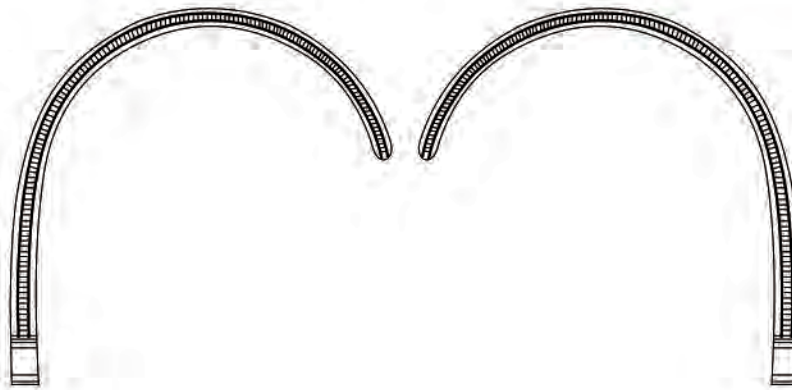

13-2536
Weber
24 cm

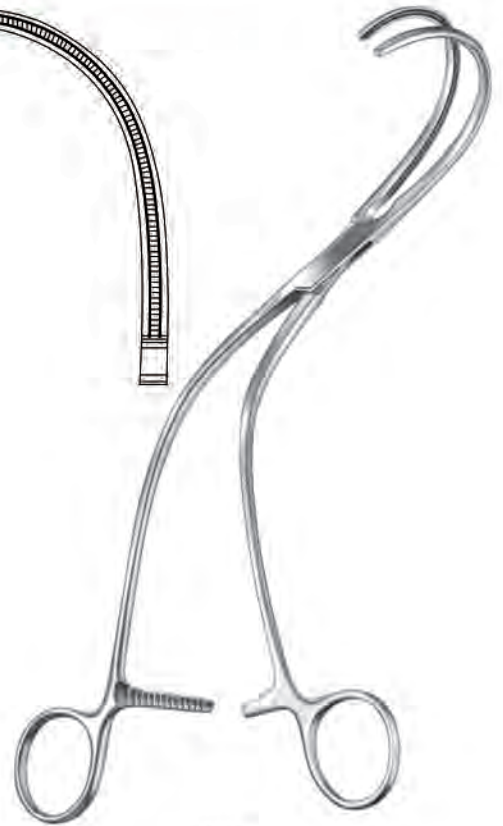

13-2537
20 cm

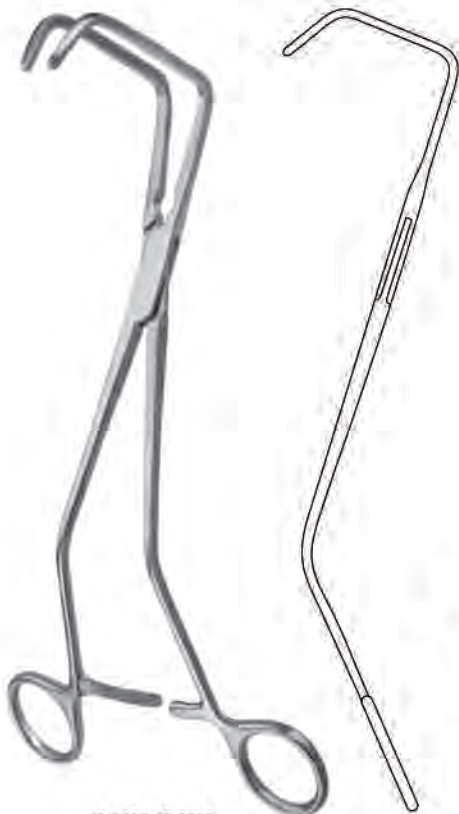

13-2537-13-2539

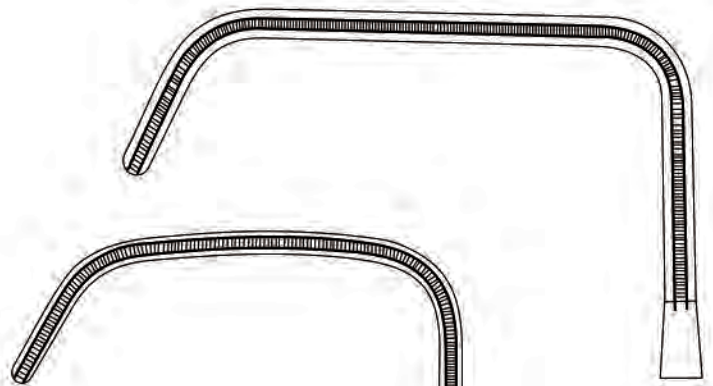

13-2539
20 cm

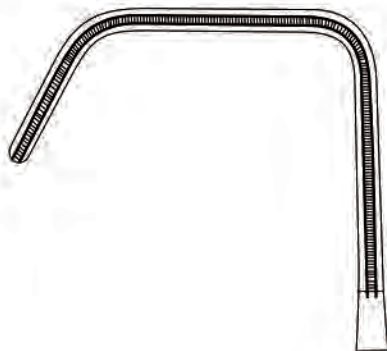

13-2538
20 cm



Forceps for kidney and pancreas,
Auricle Clamps, Bronchus Clamps



M.F. ELAHI MEDICAL CO
SERVING WORLDWIDE SURGICAL INSTRUMENTS

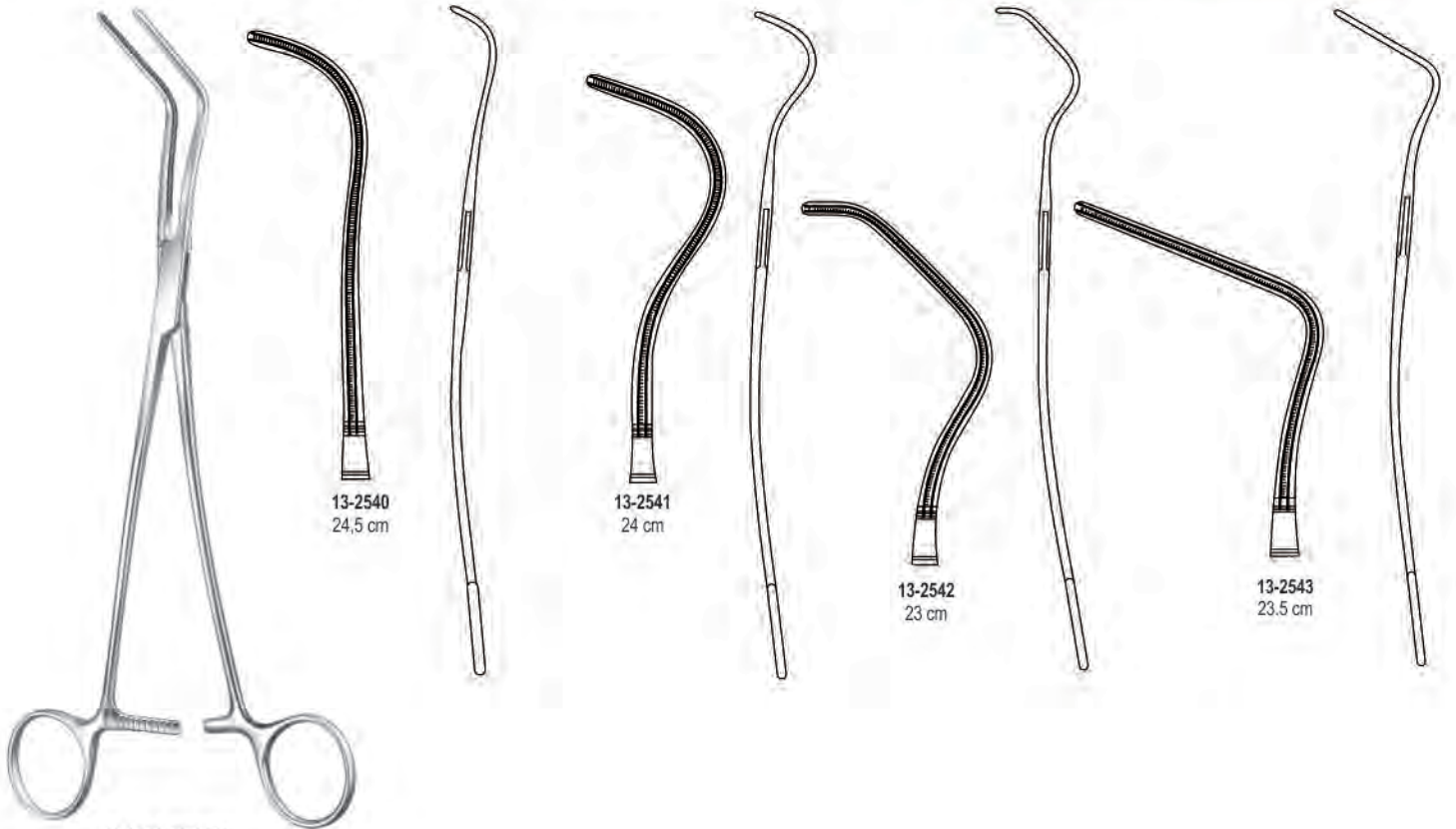

13-2540-13-2543
Harken

13-2540
24,5 cm

13-2541
24 cm

13-2542
23 cm

13-2543
23.5 cm



13-2544
Satinsky
15,5 cm



13-2545-13-2546
Lees

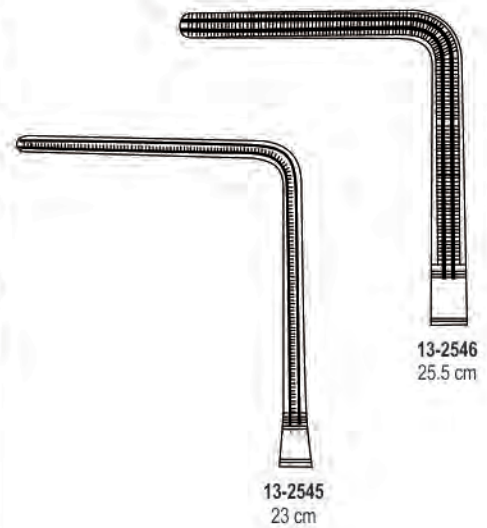

13-2545
23 cm

13-2546
25.5 cm



Bronchus Clamps, Anastomosis Clamps,
Aorta-Anastomosis Clamps



M.F. ELAHI MEDICAL CO
SERVING WORLDWIDE SURGICAL INSTRUMENTS

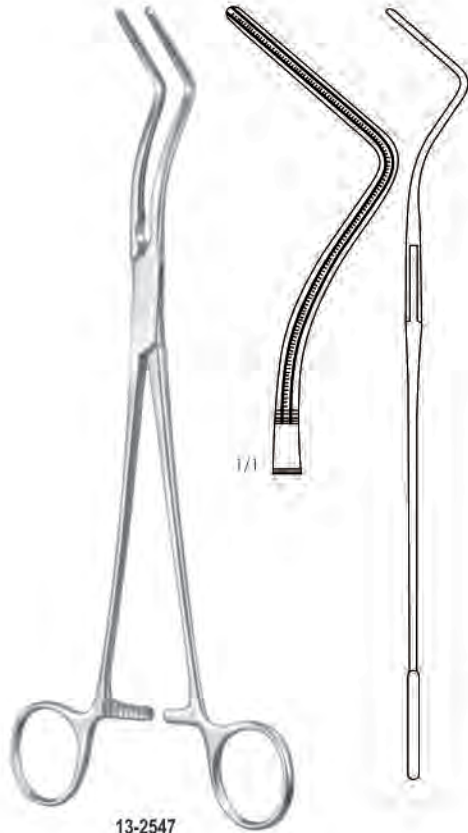

13-2547
Lees
26 cm



13-2548-13-2549
Glover

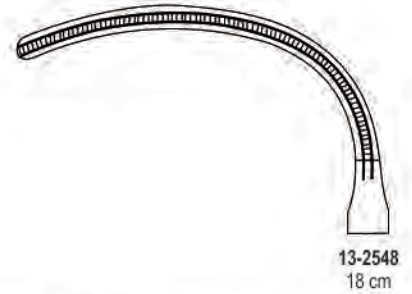

13-2548
18 cm

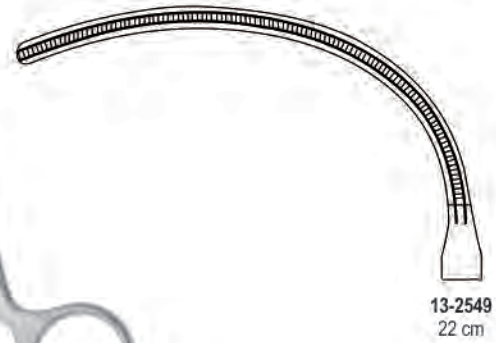

13-2549
22 cm



13-2550-13-2551
Lambert-Kay

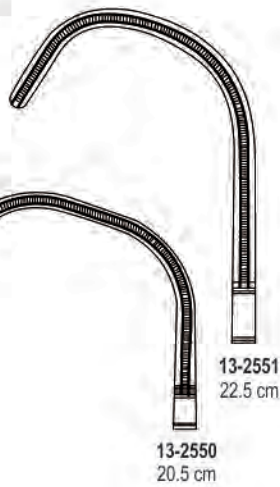

13-2550
20.5 cm

13-2551
22.5 cm



13-2552
De Bakay
16,5 cm

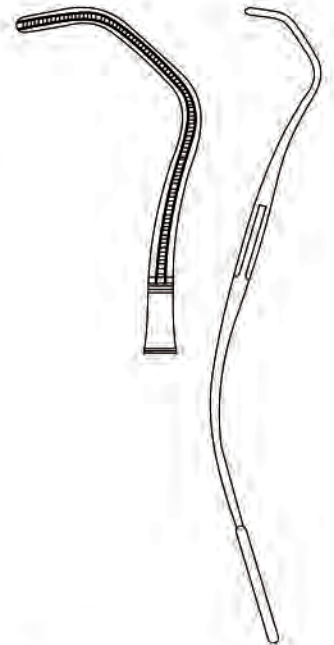

Aortic Clamps, Aneurysm Clamps,
Multi purpose Vascular Clamps



M.F. ELAHI MEDICAL CO
SERVING WORLDWIDE SURGICAL INSTRUMENTS



13-2553-13-2556
Morris-De Bakey

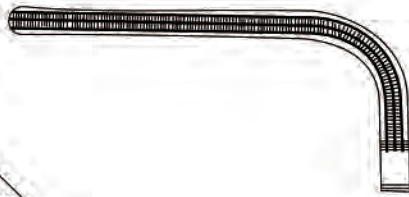

13-2553
18,5 cm



13-2554
26 cm

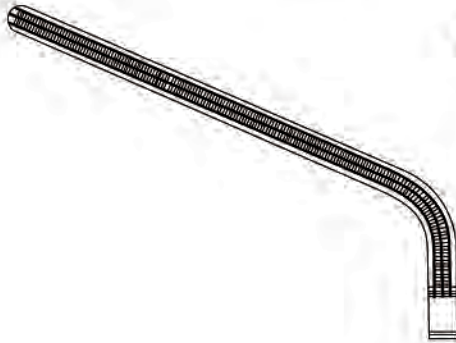

13-2555
27,5 cm

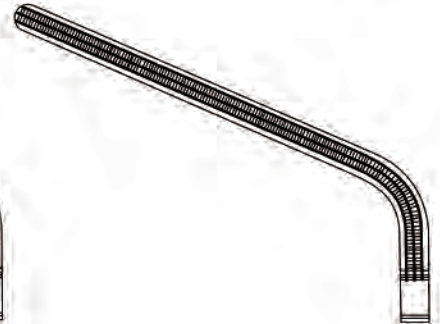

13-2556
20 cm



13-2557-13-2559
De Bakey-Bahnson



13-2557
23,5 cm

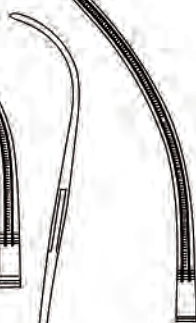

13-2558
24,5 cm

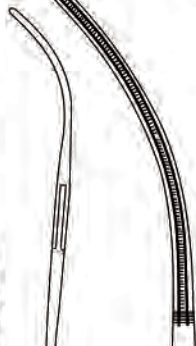

13-2559
25,5 cm



13-2560-13-2563
Potts



13-2560
21,5 cm



13-2561
23,5 cm



13-2562
27 cm



13-2563
31 cm

Multi purpose Vascular Clamps



M.F. ELAHI MEDICAL CO
SERVING WORLDWIDE SURGICAL INSTRUMENTS



13-2564-13-2567
Potts

13-2564
21 cm

13-2565
23 cm

13-2566
26 cm

13-2567
31 cm

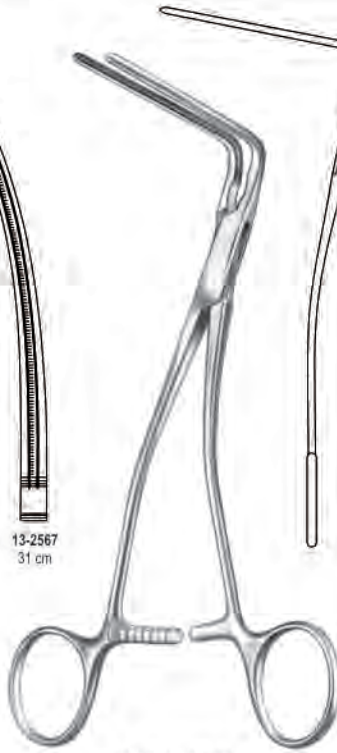

13-2568-13-2571
De Bakey

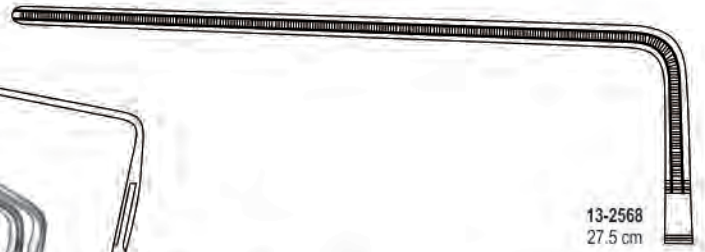

13-2568
27.5 cm



13-2569
23 cm



13-2570
20 cm



13-2571
19 cm



13-2571-13-2575
De Bakey-Bahnson



13-2572
21 cm

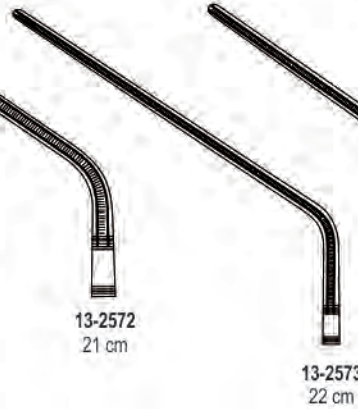

13-2573
22 cm



13-2574
26 cm

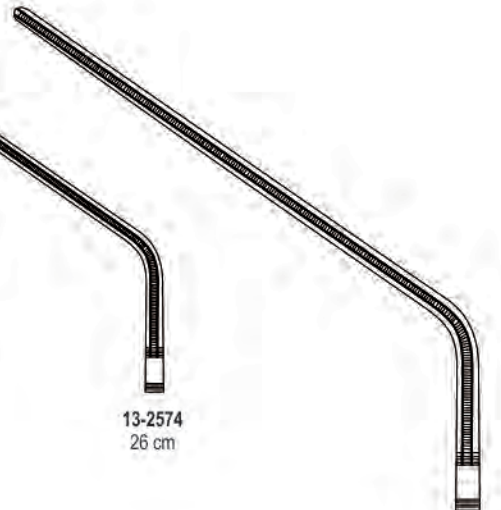

13-2575
31.5 cm



Haemostatic Forceps, Multi purpose
Vascular Clamps



M.F. ELAHI MEDICAL CO
SERVING WORLDWIDE SURGICAL INSTRUMENTS

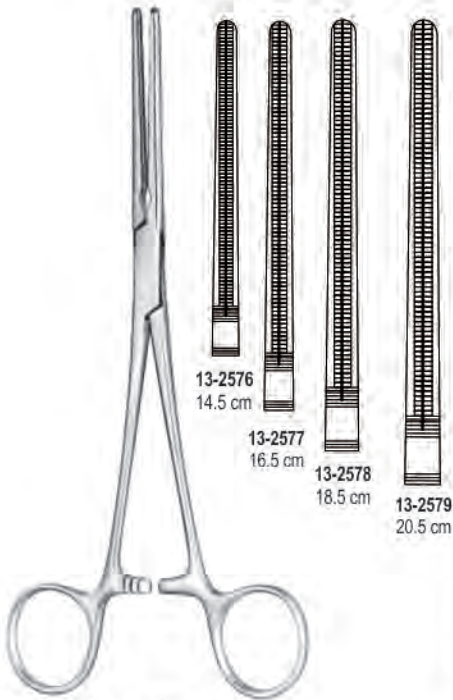

13-2576-13-2579
De Bakey-Pean

13-2576
14.5 cm
13-2577
16.5 cm
13-2578
18.5 cm
13-2579
20.5 cm

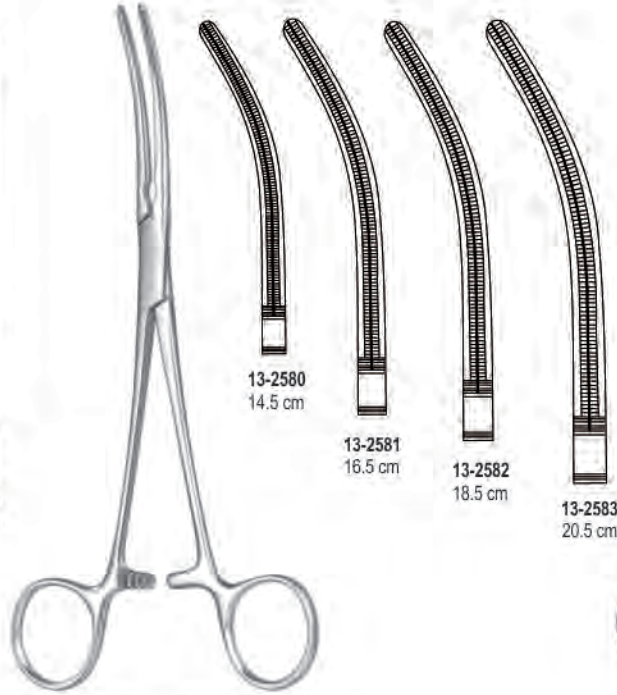

13-2580-13-2583
De Bakey-Pean

13-2580
14.5 cm
13-2581
16.5 cm
13-2582
18.5 cm
13-2583
20.5 cm

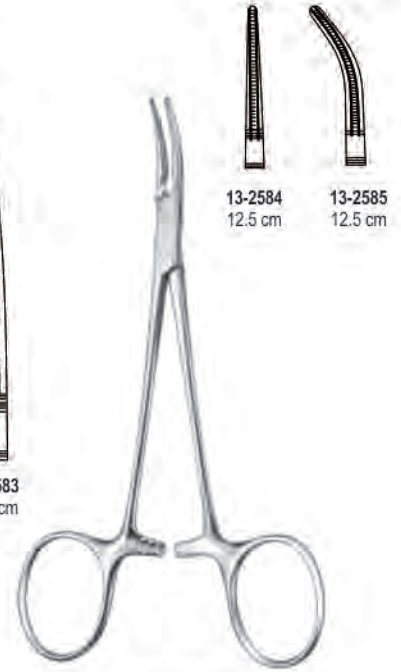

13-2584-13-2585
De Bakey-Mosquito

13-2584
12.5 cm
13-2585
12.5 cm

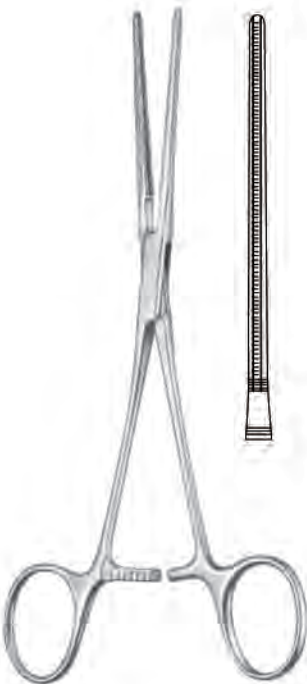

13-2586
De Bakey
17.5 cm

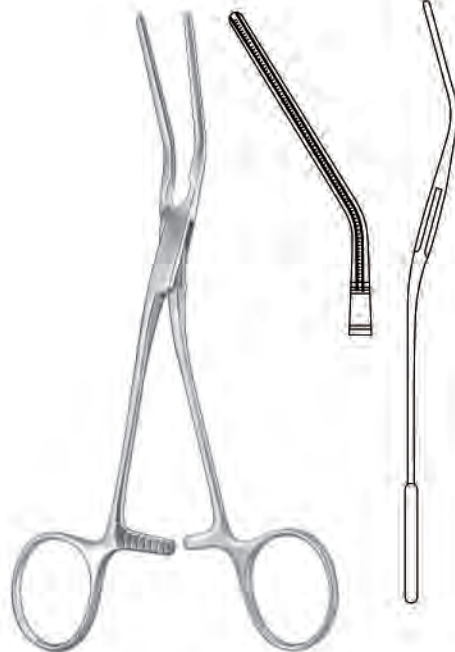

13-2587
De Bakey
16.5 cm



13-2588
De Bakey
16 cm



Haemostatic Forceps, Multi purpose
Vascular Clamps, Anastomosis Clamps



M.F. ELAHI MEDICAL CO
SERVING WORLDWIDE SURGICAL INSTRUMENTS



13-2589
De Bakey
15 cm

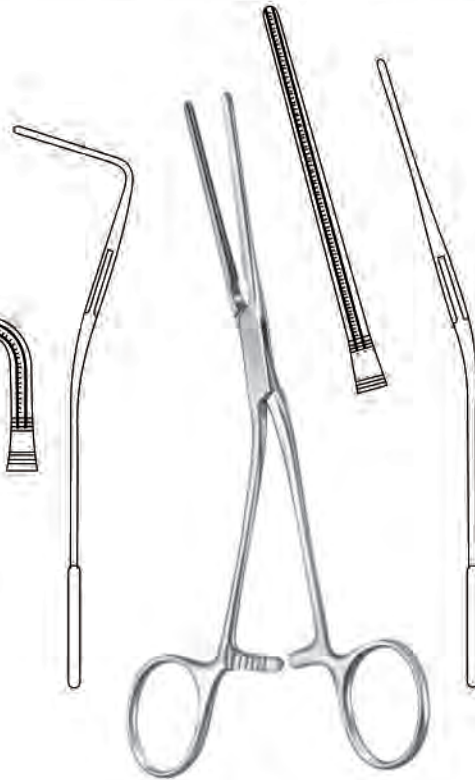

13-2590
De Bakey
16,5 cm



13-2591
Glover
17 cm

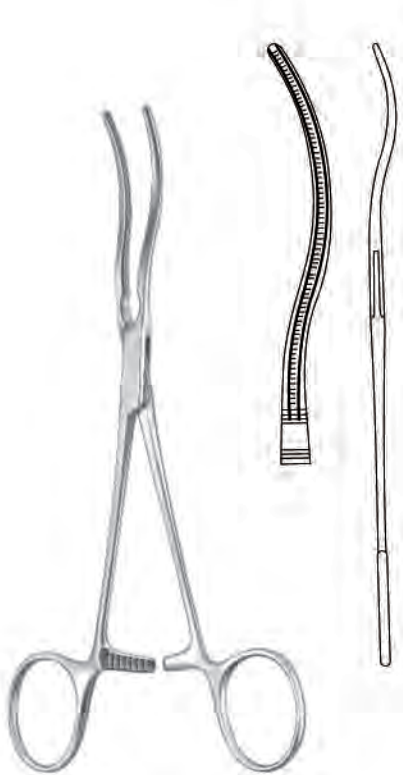

13-2592
Glover
17,5 cm

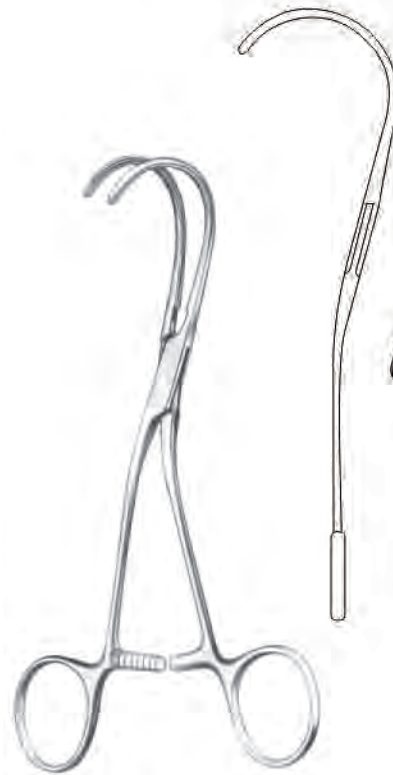

13-2593-13-2594
De Bakey

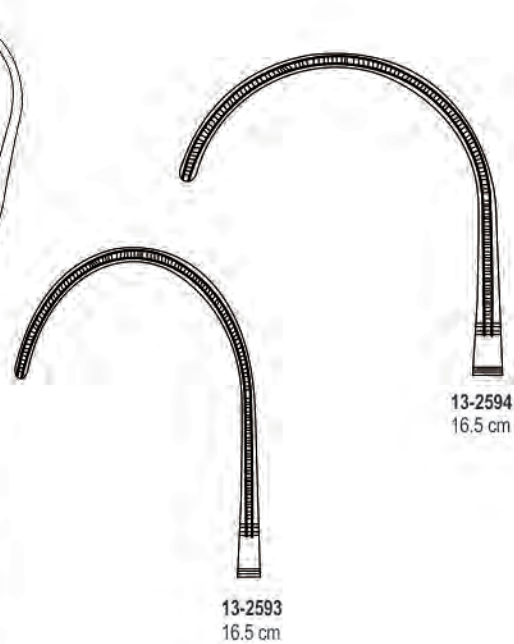

13-2594
16.5 cm

13-2593
16.5 cm



Anastomosis Clamps



M.F.ELAHI MEDICAL CO
SERVING WORLDWIDE SURGICAL INSTRUMENTS

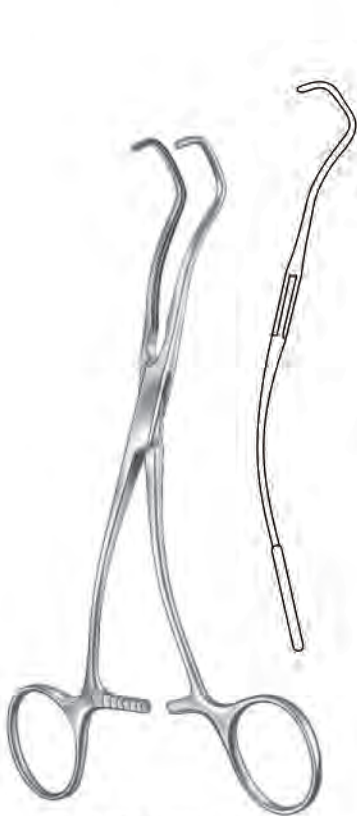

13-2595-13-2597
Derra

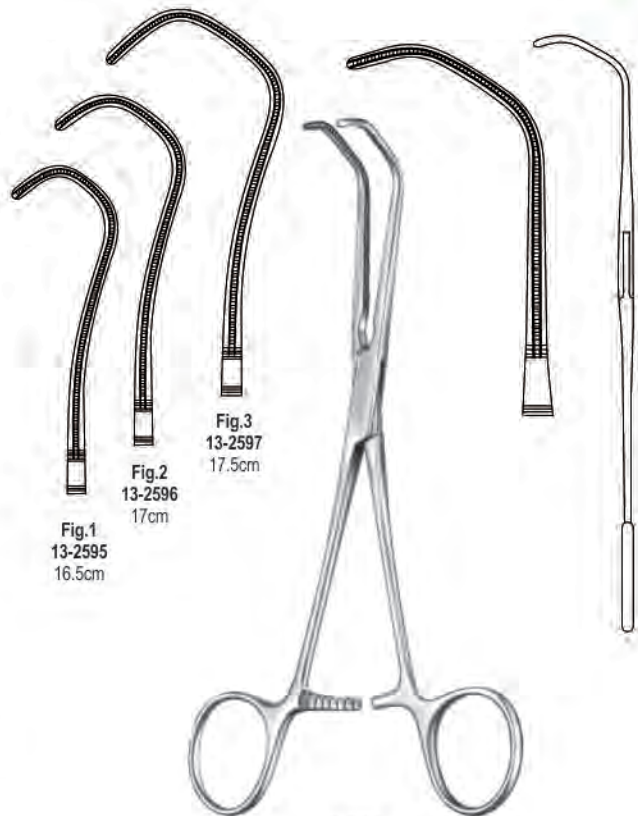

Fig.1
13-2595
16.5cm

Fig.2
13-2596
17cm

Fig.3
13-2597
17.5cm

13-2598
De Bakey-Beck
17 cm



13-2599
13 cm



13-2600
De Bakey
10 cm



13-2601
De Bakey
13 cm

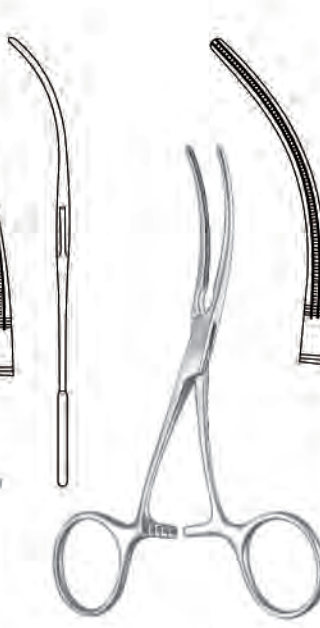

13-2602
De Bakey
12,5 cm

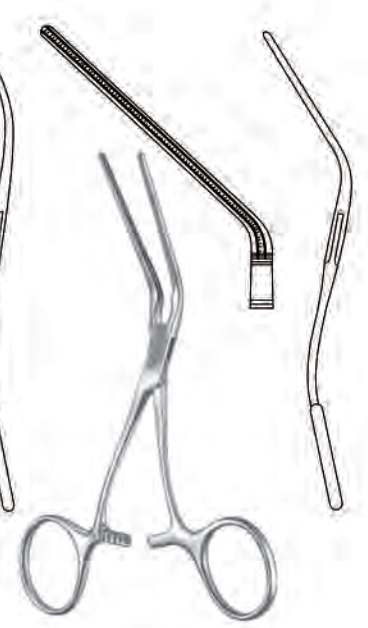

13-2603
De Bakey
12,5 cm

Pediatric Vascular Clamps, Anastomosis Clamps,
Multi purpose Vascular Clamps



M.F. ELAHI MEDICAL CO
SERVING WORLDWIDE SURGICAL INSTRUMENTS



13-2604-13-2605
Cooley
14,5 cm

13-2606
Cooley
14,5 cm

13-2607
Cooley
14 cm

13-2608
Cooley
14,5 cm



13-2609
Cooley
20 cm

13-2610
Cooley
17 cm

13-2611
Cooley
22 cm

13-2612
Cooley
17 cm



Anastomosis Clamps, Multi purpose
Vascular Clamps,



M.F. ELAHI MEDICAL CO
SERVING WORLDWIDE SURGICAL INSTRUMENTS



13-2613
Cooley
16 cm



13-2614
Cooley
14,5 cm



13-2615
Cooley
16 cm

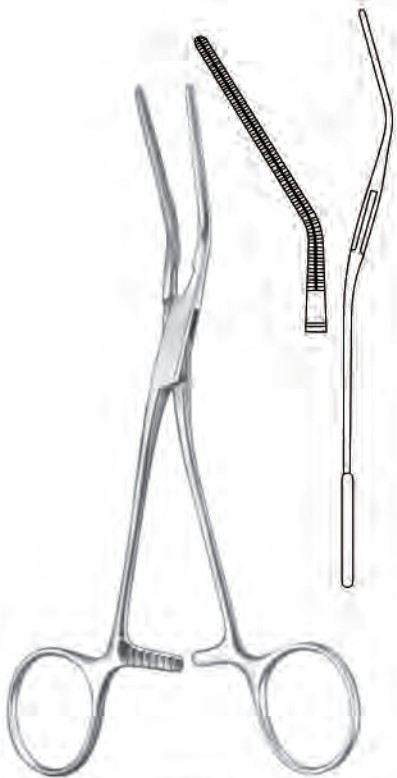

13-2616
Cooley
16,5 cm



13-2617
Cooley
17 cm

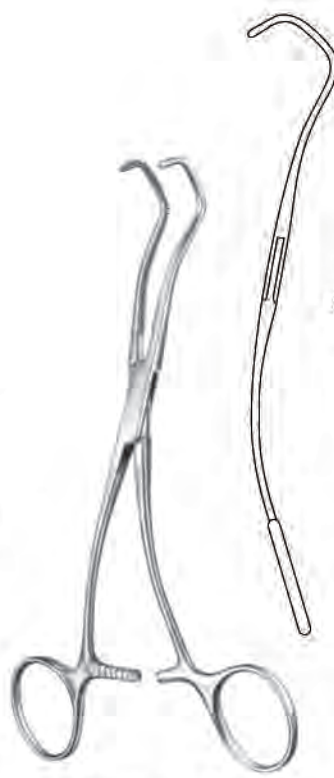

13-2618-13-2620
Cooley-Derra

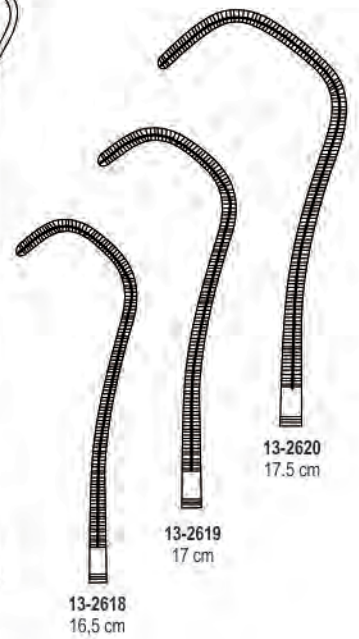

13-2618
16,5 cm

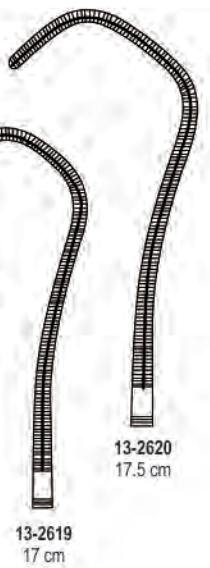

13-2619
17 cm

13-2620
17,5 cm



Anastomosis Clamps, Vascular Dilators,
Nerve Hooklets, Tourniquets



M.F. ELAHI MEDICAL CO
SERVING WORLDWIDE SURGICAL INSTRUMENTS



13-2621
Tubbs
spreading 8 - 42 mm, with fixation screw
for mitral stenosis



13-2622
Cooley
spreading 5 - 20 mm, with thread fixation
for mitral stenosis



13-2623-13-2634
De Bakey
19 cm

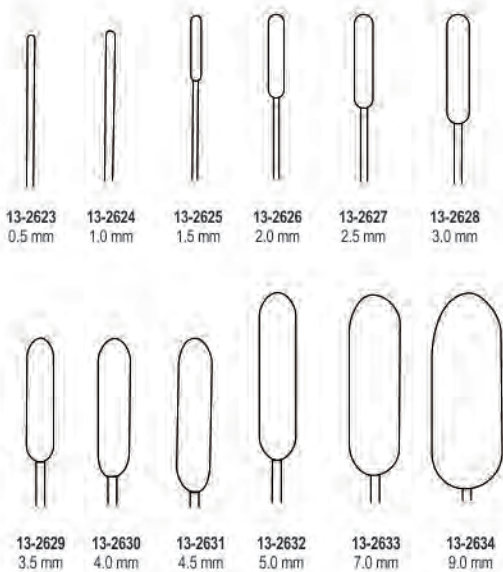

13-2623 0.5 mm
13-2624 1.0 mm
13-2625 1.5 mm
13-2626 2.0 mm
13-2627 2.5 mm
13-2628 3.0 mm

13-2629 3.5 mm
13-2630 4.0 mm
13-2631 4.5 mm
13-2632 5.0 mm
13-2633 7.0 mm
13-2634 9.0 mm



13-2635
Criele
20 cm

13-2636
Criele
20,5 cm



13-2637-13-2640
26 cm

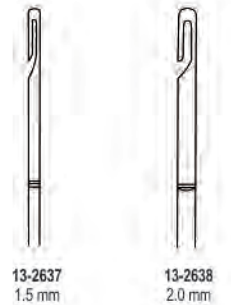

13-2637 1.5 mm
13-2638 2.0 mm

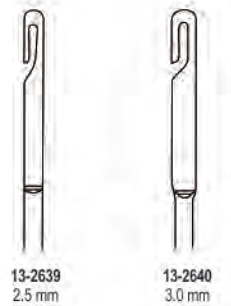

13-2639 2.5 mm
13-2640 3.0 mm

Pediatric Aortic Clamps, Pediatric Vascular Clamps



M.F. ELAHI MEDICAL CO
SERVING WORLDWIDE SURGICAL INSTRUMENTS



13-2641
Subramanian-Miniature
16,5 cm

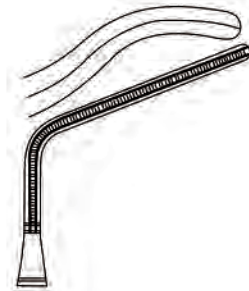

135°



13-2642-13-2648
Castañeda

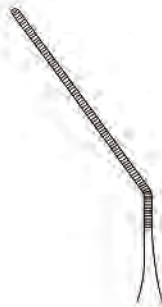

13-2642
12,5 cm



13-2643
12 cm



13-2644
11 cm



13-2645
12 cm



13-2646
12 cm



13-2647
12 cm



13-2648
12 cm

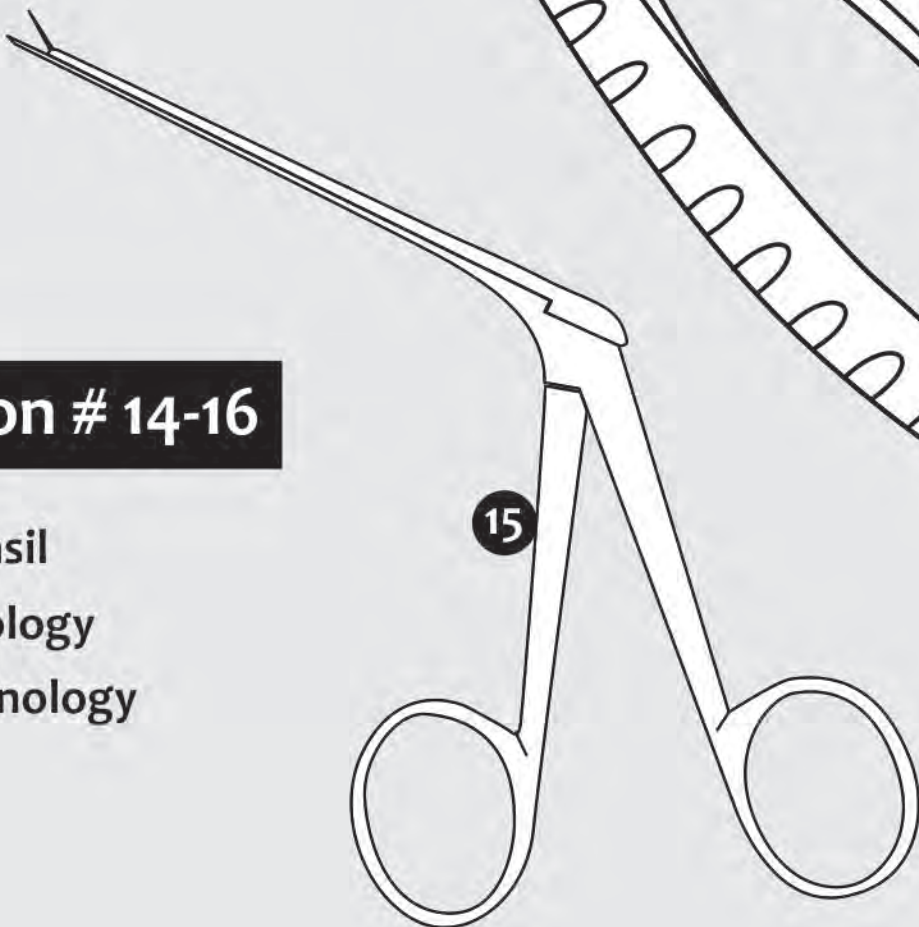
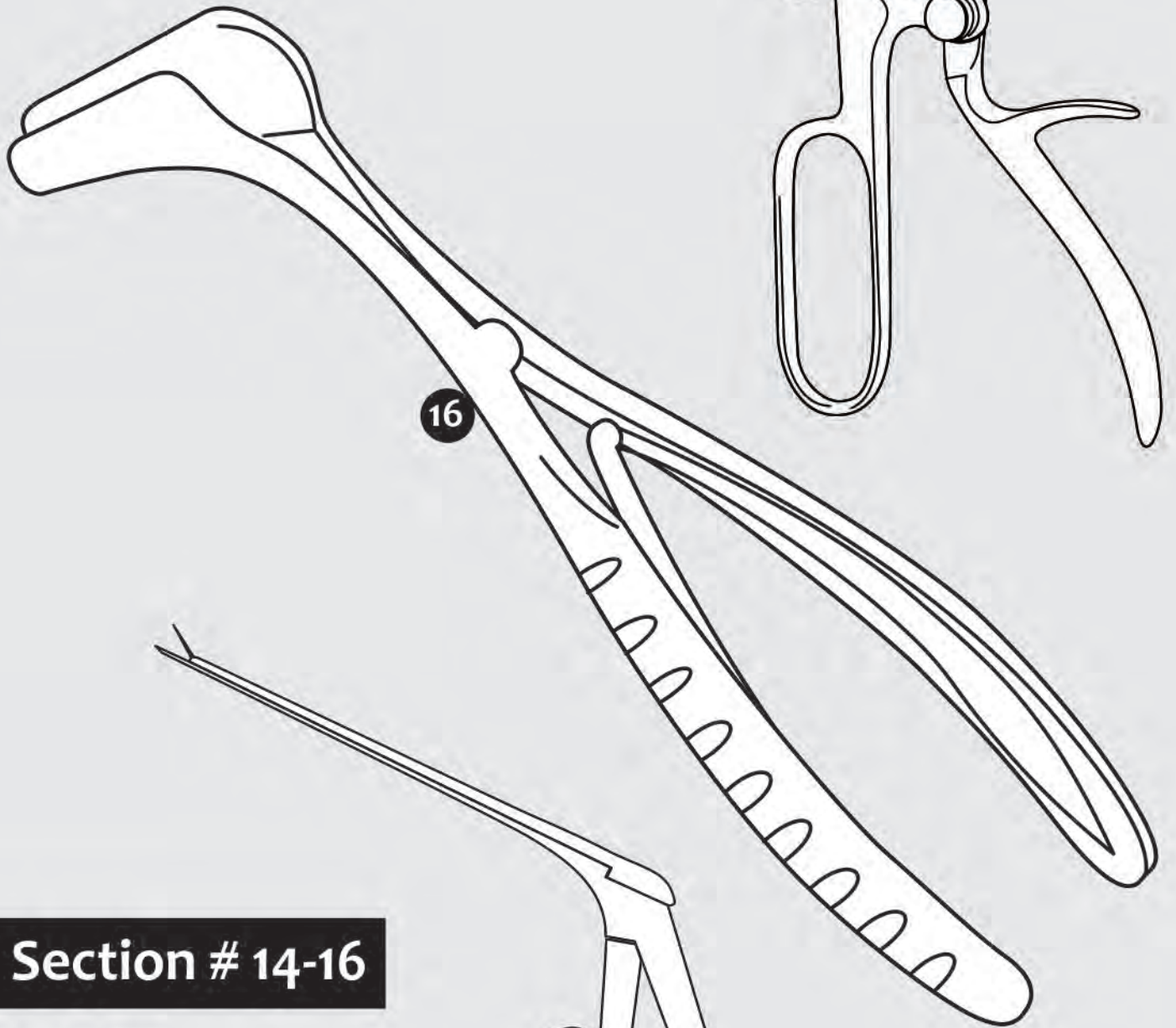
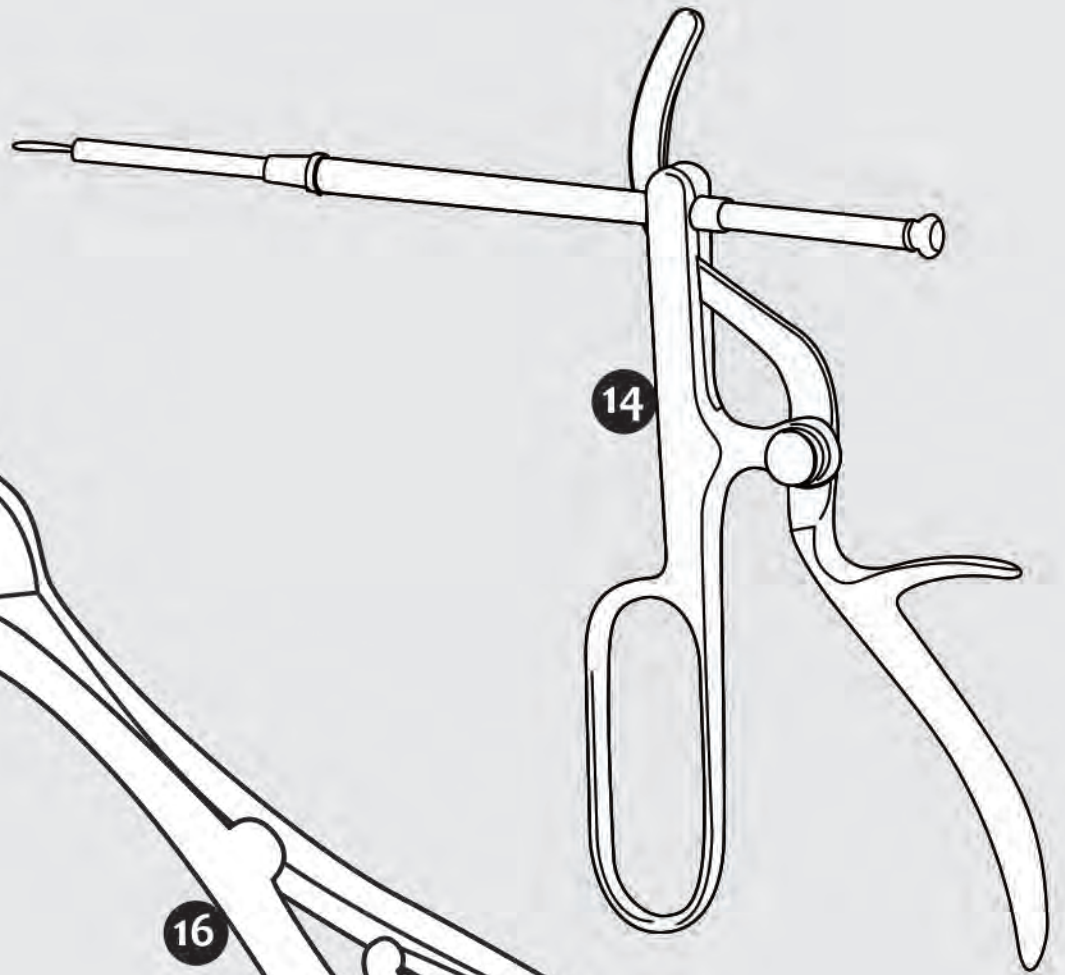

Section # 14-16

- 14** Tonsil
- 15** Otology
- 16** Rhinology

Cleft Palate Needles, Tonsil Knife



M.F. ELAHI MEDICAL CO
SERVING WORLDWIDE SURGICAL INSTRUMENTS



14-2700
Hurd
20,5 cm / 8 1/8"



14-2701
Hurd
20,5 cm / 8 1/8"



14-2702
Day
21.5 cm



2 mm

14-2703

2 mm

14-2703-14-2704
Luniatschek
17,5 cm / 6 7/8"



3 mm

14-2704

2 mm



14-2705
Luniatschek
17,5 cm / 6 7/8"



2 mm

2 mm



14-2706
Nager
24 cm / 9 1/2"



14-2707
Falk
24 cm / 9 1/2"

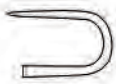

14-2708
Falk
24 cm / 9 1/2"



14-2709
Claus-Eicken
23 cm / 9"



14-2710-14-2711
DURHAM



14-2712-14-2713
Rotter



14-2714
Fisher
22,5 cm / 8 7/8"



14-2715
Douglas
21 cm / 8 1/4"



4.5 mm



14-2716
Brünings
23 cm / 9"

9.0 mm

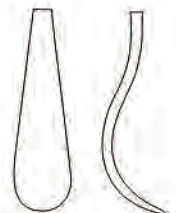

14-2717
Carpenter
25 cm / 9 7/8"



Cleft Palate Needles, Tonsil Knife, Tonsil Dissectors



M.F. ELAHI MEDICAL CO
SERVING WORLDWIDE SURGICAL INSTRUMENTS



14-2718
Carpenter
25.0cm



14-2719
Abraham
21 cm/8 1/4"



14-2720
Tydins
21 cm



14-2721
Canfield
21 cm/8 1/4"



14-2722
Colver
22.5 cm



14-2723-14-2724
Dupy-Weiss
22 cm



14-2725
Lynch
20 cm



14-2726
Marschik
22 cm



14-2727
Hurd
22.5 cm / 8 7/8"



14-2728
Henke
24.5 cm / 9 5/8"

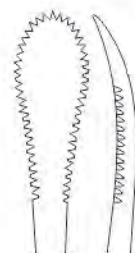

11.5mm



16.5mm

5.0mm

5.0mm

14-2729
Henke
24.5 cm / 9 5/8"



14-2730
Molison Pillar
double ended
21cm/8 1/4"



14-2731
Gwynee Evans Dissector
double ended,
6mm, 20cm/8"
8mm, 20cm/8"



14-2732
Yankauer
21cm/8 1/4"



14-2733
Negus Knot Tier
and Pusher
20 cm/8"



Tonsil Dissectors, Tonsil Seizing Forceps



M.F. ELAHI MEDICAL CO
SERVING WORLDWIDE SURGICAL INSTRUMENTS



14-2734
Nager
23 cm/9"



14-2735
Love
23 cm/9"



14-2736
Haslinger



14-2737
Hofer
24 cm/9 1/2"

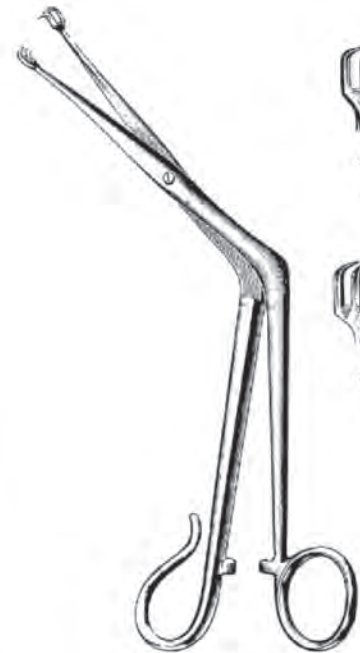

14-2738-14-2739
TIVNEN-TYDING
21.0cm



14-2738
Fig. 1



14-2739
Fig. 2



14-2740
MUSEUX
20.0cm



14-2741
MUSEUX
20.0cm



14-2742
BALLENGER
21.5cm

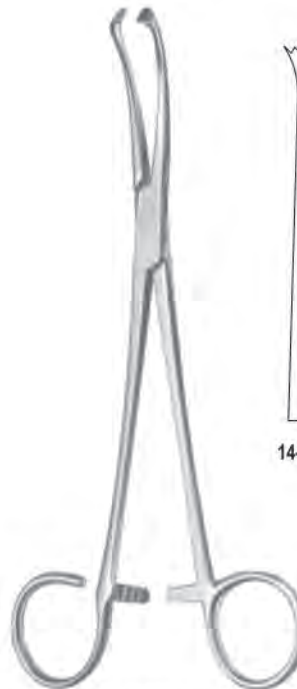

14-2743
White
18 cm / 7 1/8"



14-2744

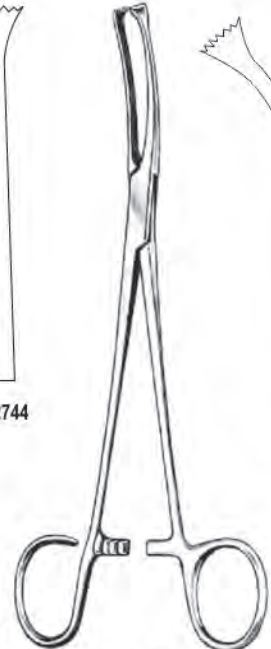

14-2744-14-2745
COLVER
19.0cm

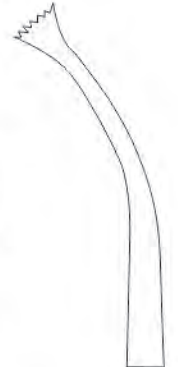

14-2745

Tonsil Dissectors, Tonsil Seizing Forceps



M.F. ELAHI MEDICAL CO
SERVING WORLDWIDE SURGICAL INSTRUMENTS



14-2746
19 cm / 7 4/8"

14-2746-14-2747
Schnidt

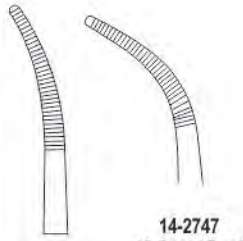

14-2747
18,5 cm / 7 2/8"



14-2748
19 cm / 7 4/8"

14-2748-14-2749
Schnidt

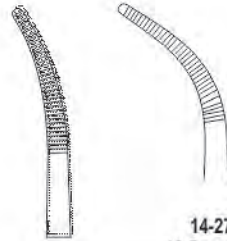

14-2749
18,5 cm / 7 2/8"



14-2750
Blohmke
20 cm / 7 1/8"



14-2751
DENIS-BROWNE
18.0cm
21.0cm



14-2752
McWHOPPER-LOTHROP
18.0cm



14-2753
THILENIUS
20.0cm



14-2754-14-2755
NEGUS
19.0cm



14-2754 14-2755

Tonsil Seizing Forceps, Tonsil Snares



M.F. ELAHI MEDICAL CO
SERVING WORLDWIDE SURGICAL INSTRUMENTS

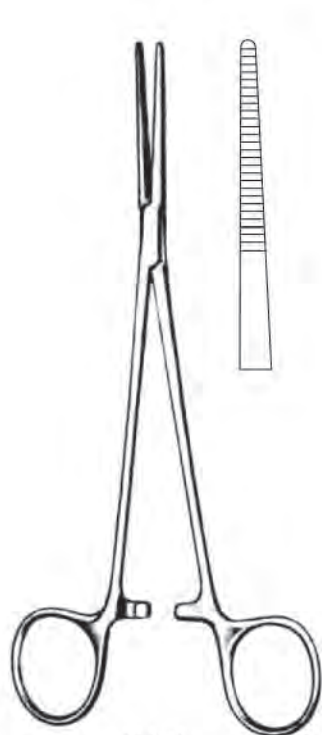

14-2756
BIRKETT
19.0cm

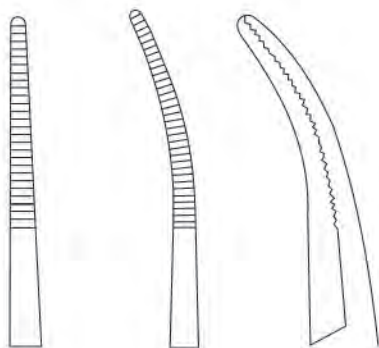

14-2757
WILSON
19.0cm



14-2758
Mollison
18.0cm (with horizontal opening)
18.0cm (with vertical opening)



14-2759
Eves
28.5 cm / 11 2/8"



14-2760
Eves
28.5 cm / 11 2/8"



14-2761
Brünings
29 cm / 11 3/8"



39-511-40
Ø 40 x 0,3 mm
39-511-50
Ø 50 x 0,3 mm

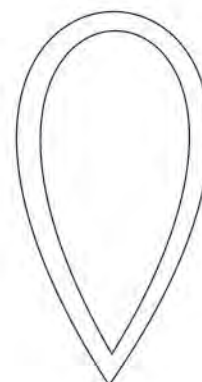

14-2762



Tonsil Snares, Broncho-Esophagoscopy Forceps



M.F.ELAHI MEDICAL CO
SERVING WORLDWIDE SURGICAL INSTRUMENTS

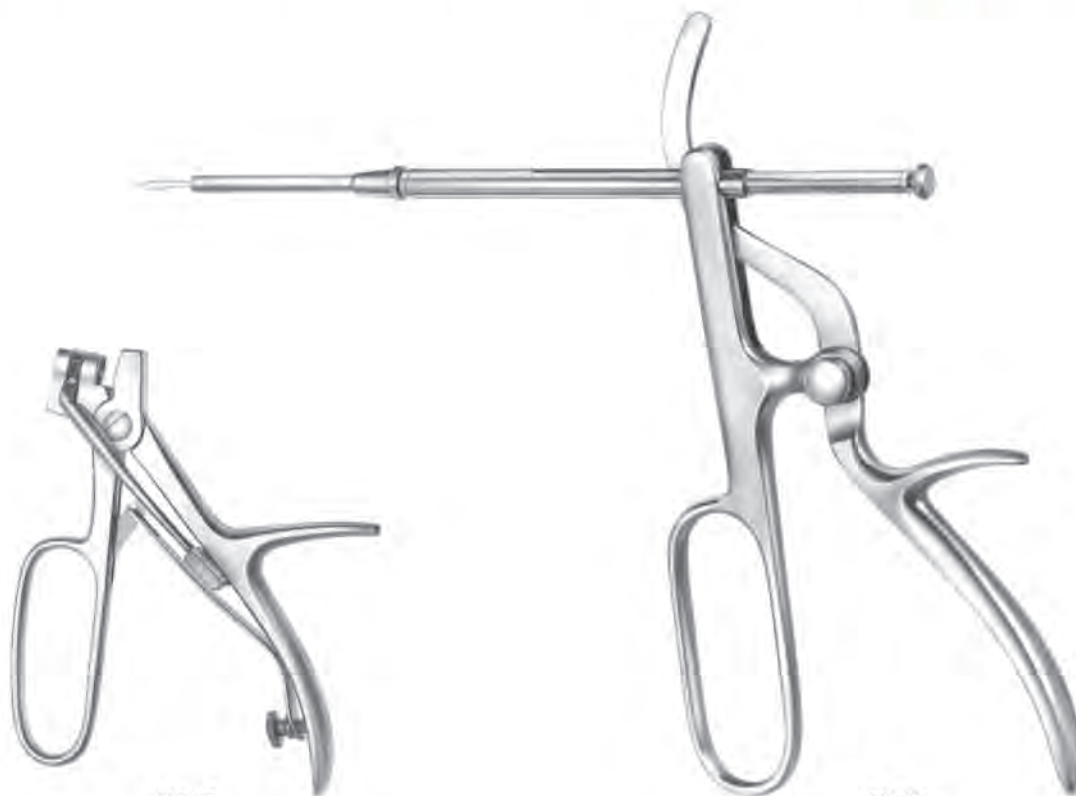

14-2763
Huber

14-2764
Tyding



14-2765
Brünings

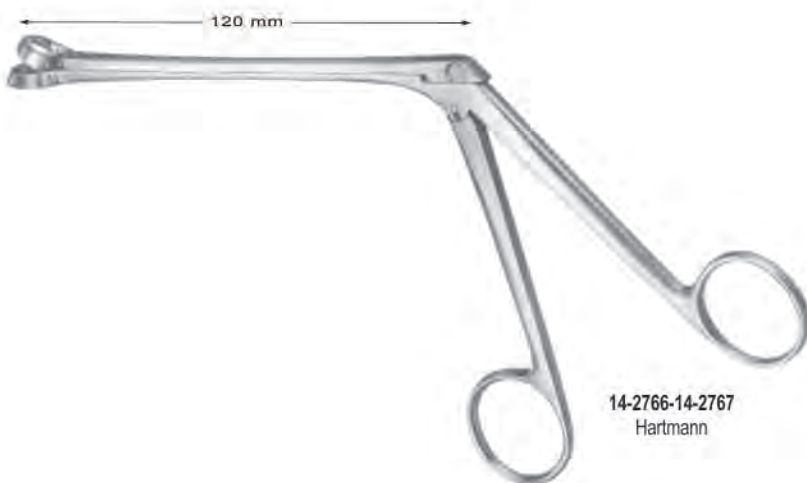

14-2766-14-2767
Hartmann



14-2766
Schnitt
cut
corte
tranchant
tagliente
Ø 13 mm



14-2767
Schnitt
cut
corte
tranchant
tagliente
Ø 15 mm

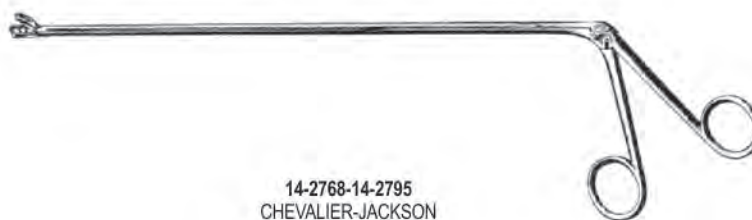

14-2768-14-2795
CHEVALIER-JACKSON

30.0cm	14-2768	14-2772	14-2776	14-2780	14-2784	14-2788	14-2792	
40.0cm	14-2769	14-2773	14-2777	14-2781	14-2785	14-2789	14-2793	
50.0cm	14-2770	14-2774	14-2778	14-2782	14-2786	14-2790	14-2794	
60.0cm	14-2771	14-2775	14-2779	14-2783	14-2787	14-2791	14-2795	



14-2796
Brünings



Exchangeable Tips



14-2797
Fraenkel



14-2798
Seiffert



14-2799
Fraenkel



14-2800
Scheinmann



14-2801
Scheinmann



14-2802
Brünings



14-2803
Lange



14-2804
Brünings



14-2805
Krause



14-2806
Krause



14-2807
Cordes



14-2808
Schumacher



14-2809
Cordes



14-2810
Cordes



14-2811
Rosenberg



14-2812
Baracani



14-2813-14-2825
Laryngeal mirrors with hexagonal handle
Size: 180 mm



14-2813
Fig. 000
Ø 6mm



14-2814
Fig. 00
Ø 8mm



14-2815
Fig. 0
Ø 10mm



14-2816
Fig. 1
Ø 12mm



14-2817
Fig. 2
Ø 14mm



14-2818
Fig. 3
Ø 16mm



14-2819
Fig. 4
Ø 18mm



14-2820
Fig. 5
Ø 20mm



14-2821
Fig. 6
Ø 22mm



14-2822
Fig. 7
Ø 24mm



14-2823
Fig. 8
Ø 26mm



14-2824
Fig. 9
Ø 28mm



14-2825
Fig. 10
Ø 30mm



14-2826
FRANCKE
Automatic blood lancet



14-2827
Mirror handle
Size: 105 mm



14-2828
KOLLE
Microscopic
Needle Holder
with plastic
handle.
Size: 240 mm



14-2829
Mirror handle
Size: 110 mm



14-2830-14-2831
MICHEL Rhinoscopic
mirrors with interchangeable
mirror inserts, Size: 250 mm



14-2830
Spare mirrors only
Size: 12 mm





14-2831
Spare mirrors only
Size: 14 mm

Ear Specula



M.F.ELAHI MEDICAL CO
SERVING WORLDWIDE SURGICAL INSTRUMENTS

		<p>①</p> <p>Fig. 0 15-2903 3.6 cm Ø 3.0 mm</p>			
		<p>①</p> <p>Fig. 1 15-2904 3.6 cm Ø 4.0 mm</p>		<p>①</p> <p>Fig. 1 15-2908 3.6 cm Ø 4.0 mm</p>	<p>①</p> <p>Fig. 1 15-2912 3.6 cm Ø 5.5 mm</p>
	<p>①</p> <p>Fig. 0 15-2900 Ø 3 mm</p>	<p>②</p> <p>Fig. 2 15-2905 3.6 cm Ø 5.0 mm</p>		<p>②</p> <p>Fig. 2 15-2909 3.6 cm Ø 5.0 mm</p>	<p>②</p> <p>Fig. 2 15-2913 3.6 cm Ø 6.5 mm</p>
	<p>①</p> <p>Fig. 1 15-2901 Ø 4 mm</p>	<p>③</p> <p>Fig. 3 15-2906 3.6 cm Ø 6.0 mm</p>		<p>③</p> <p>Fig. 3 15-2910 3.6 cm Ø 6.0 mm</p>	<p>③</p> <p>Fig. 3 15-2914 3.6 cm Ø 7.5 mm</p>
	<p>②</p> <p>Fig. 2 15-2902 Ø 5 mm</p>	<p>④</p> <p>Fig. 4 15-2907 3.6 cm Ø 7.5 mm</p>		<p>④</p> <p>Fig. 4 15-2911 3.6 cm Ø 7.5 mm</p>	
<p>Hartmann (for children) 15-2900-15-2902</p>		<p>Hartmann 15-2903-15-2907</p>		<p>Toynbee 15-2908-15-2911</p>	<p>Farrior 15-2912-15-2918</p>
					<p>⑤</p> <p>Fig. 5 15-2916 3.6 cm Ø 9.5 mm</p>
					<p>⑥</p> <p>Fig. 6 15-2917 3.6 cm Ø 10.5 mm</p>
					<p>⑦</p> <p>Fig. 7 15-2918 3.6 cm Ø 11.5 mm</p>

		<p>①</p> <p>Fig. 1 15-2922 Ø 4.5 mm</p>		<p>①</p> <p>Fig. 1 15-2926 Ø 4.5 mm</p>	<p>①</p> <p>Fig. 1 15-2930 Ø 3 mm</p>
	<p>①</p> <p>Fig. 1 15-2919 Ø 6 mm</p>	<p>②</p> <p>Fig. 2 15-2923 Ø 5.5 mm</p>		<p>②</p> <p>Fig. 2 15-2927 Ø 5.5 mm</p>	<p>②</p> <p>Fig. 2 15-2931 Ø 4.5 mm</p>
	<p>②</p> <p>Fig. 2 15-2920 Ø 7 mm</p>	<p>③</p> <p>Fig. 3 15-2924 Ø 6.5 mm</p>		<p>③</p> <p>Fig. 3 15-2928 Ø 6.5 mm</p>	<p>③</p> <p>Fig. 3 15-2932 Ø 5.5 mm</p>
	<p>③</p> <p>Fig. 3 15-2921 Ø 8 mm</p>	<p>④</p> <p>Fig. 4 15-2925 Ø 7.5 mm</p>		<p>④</p> <p>Fig. 4 15-2929 Ø 7.5 mm</p>	
<p>Troeltsch 15-2919-15-2921</p>		<p>Gruber (for adults) 15-2922-15-2925</p>		<p>Gruber 15-2926-15-2929</p>	<p>Politzer 15-2930-15-2933</p>
					<p>④</p> <p>Fig. 4 15-2933 Ø 6.5 mm</p>

Ear Specula, Ear Syringes, Tuning Forks



M.F. ELAHI MEDICAL CO
SERVING WORLDWIDE SURGICAL INSTRUMENTS



Siegle
15-2934



15-2935



Bruenings
15-2936



15-2937



15-2938



15-2939



15-2940

Tuning Forks



M.F. ELAHI MEDICAL CO
SERVING WORLDWIDE SURGICAL INSTRUMENTS



Hartmann
15-2941
C 128



Hartmann
15-2942
C1 256



Hartmann
15-2943
C2 512



Hartmann
15-2944
C3 1024



Hartmann
15-2945
C4 2048



Hartmann
15-2946
C5 4096



French
15-2947
C2 16



French
15-2948
C1 32



Hartmann
15-2949
C 64



Hartmann
15-2950
C 128



Hartmann
15-2951
C1 256



15-2952
Lucae
C 128



15-2953
Lucae
C1 256



15-2954
Lucae
C2 512



15-2955
Lucae
C3 1024



15-2956
Lucae
C4 2048



15-2957
Lucae
C5 4096



15-2958
Lucae
C 128



15-2959
Hartmann
C 128



15-2960
Hartmann
C1 256



Tuning Forks, Ear Catheters, Polypus Snare



M.F.ELAHI MEDICAL CO
SERVING WORLDWIDE SURGICAL INSTRUMENTS



15-2961
Rydel-Seiffert
C 64 / C 128

15-2962
Neuro

15-2963
Martin
C 128

15-2964
Martin
C 256

15-2965
Martin-Alloy
C 512

15-2966
Martin-Alloy
C 1024

15-2967
Martin-Alloy
C 2048

15-2971
Fig. 1

15-2976
Fig. 1

15-2972
Fig. 2

15-2977
Fig. 2

15-2968
Fig. 1

15-2973
Fig. 3

15-2978
Fig. 3

15-2969
Fig. 2

15-2974
Fig. 4

15-2979
Fig. 4

15-2970
Fig. 3

15-2975
Fig. 5

15-2980
Fig. 5

15-2968-15-2970
Hartmann
15 cm

15-2971-15-2975
Troeltsch

15-2976-15-2980
Lucae

15-2981
Woakes

15-2982-15-2986
Itard

15-2982
Fig. 1

15-2983
Fig. 2

15-2984
Fig. 3

15-2985
Fig. 4

15-2986
Fig. 5



15-2988
Krause-Voss
18.5 cm

15-2987
Krause
18.5 cm

15-2989
Ø 0.3 mm
Ø 0.4 mm

Ear Forceps, Ear Polypus Forceps



M.F.ELAHI MEDICAL CO
SERVING WORLDWIDE SURGICAL INSTRUMENTS



15-2990
Tröltsch (Wilde)
10.5 cm



15-2991
Tröltsch (Wilde)
11 cm



15-2992
Tröltsch (Wilde)
12.5 cm



15-2993
Grünwald
14.5 cm



15-2994
Jansen
16 cm

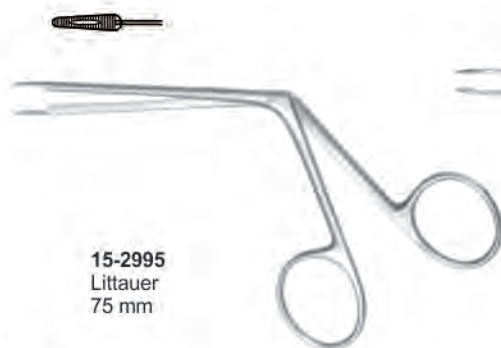

15-2995
Littauer
75 mm

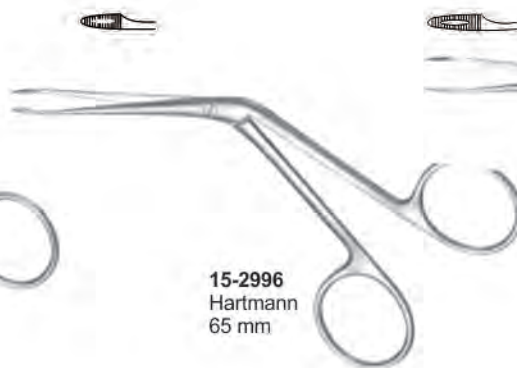

15-2996
Hartmann
65 mm

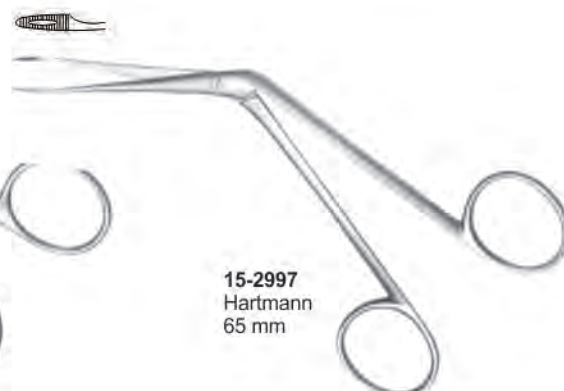

15-2997
Hartmann
65 mm



15-2998
Buck
11.5 cm



15-2999
Hartmann-Wullstein
85 mm



15-3000
Hartmann-Wullstein
85 mm
1.0 mm Ø



15-3001
Hartmann
85 mm



15-3002
Hartmann
85 mm



15-3003
Quire
10.5 cm



15-3004



Micro Ear Forceps

15-3005
4.0 x 0.8 mm

15-3006
4.0 x 0.8 mm

15-3007
4.0 x 0.8 mm

15-3008
4.0 x 0.8 mm

15-3009
4.0 x 0.8 mm

15-3010
3.5 x 0.6 mm

15-3011
3.5 x 0.6 mm

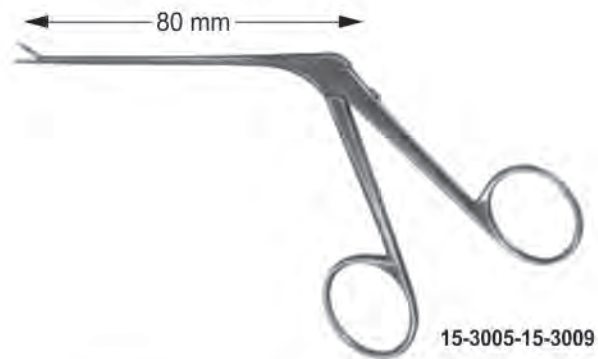
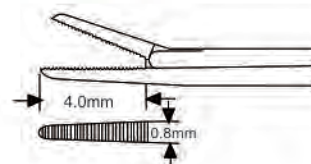
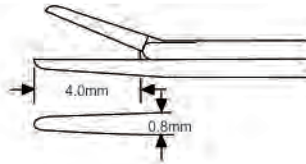

15-3005-15-3009

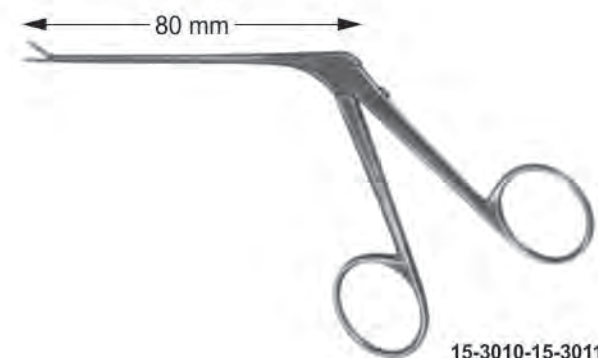
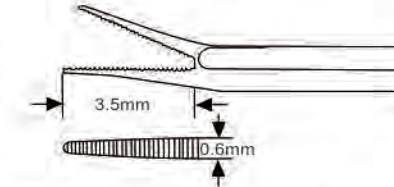
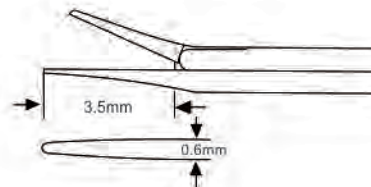

15-3010-15-3011
Mini-McGee

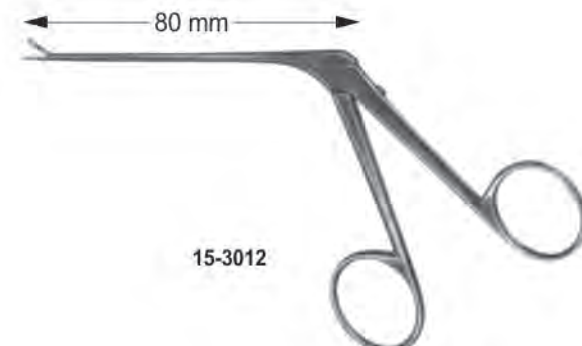
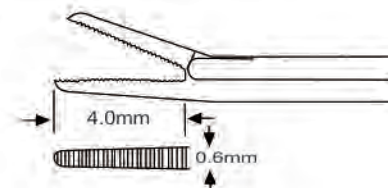

15-3012



Micro Ear Forceps



M.F.ELAHI MEDICAL CO
SERVING WORLDWIDE SURGICAL INSTRUMENTS

15-3013
4.0 x 0.6 mm

15-3014

15-3015

15-3016

15-3017
4.0 mm

15-3018
4.0 mm

15-3019
4.0 mm

15-3020
4.0 mm

15-3021
3.5 mm

15-3022
3.5 mm

15-3023
3.5 mm

15-3024
3.5 mm

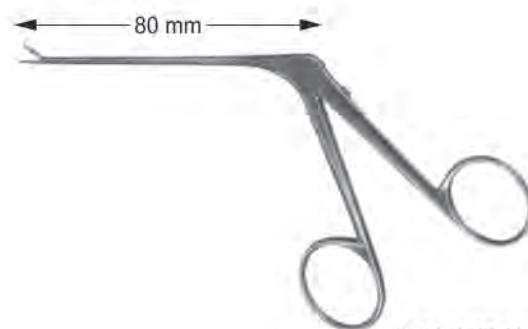
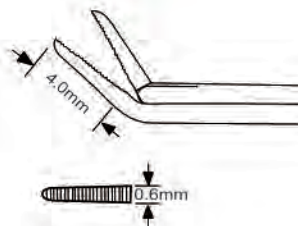
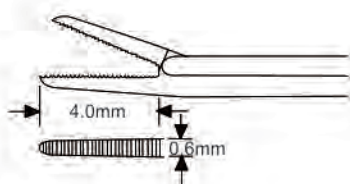

15-3013-15-3016

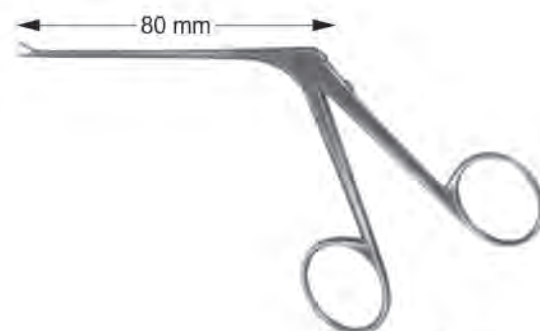
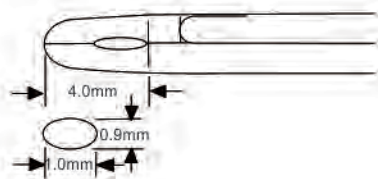

15-3017-15-3020

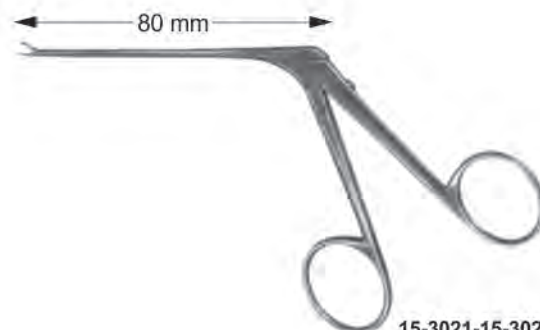
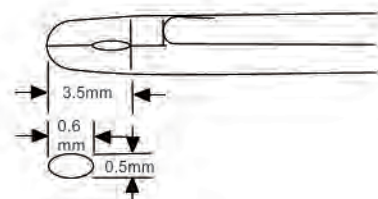

15-3021-15-3024
Mini-McGee





Micro Ear Forceps



15-3025



15-3026



15-3027



15-3028

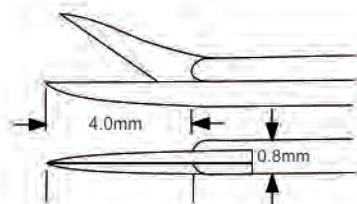

80 mm



15-3025-15-3028
Bellucci



15-3029



15-3030



15-3031



15-3032

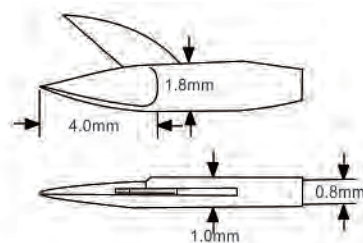

80 mm

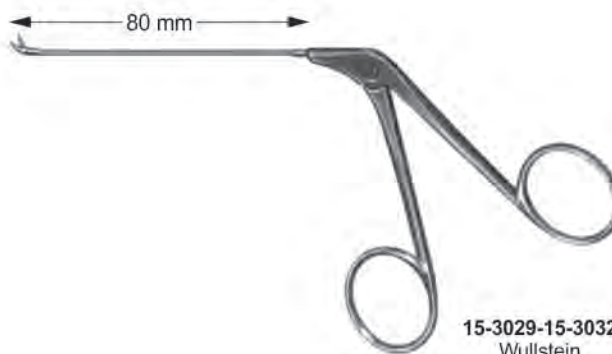

15-3029-15-3032
Wullstein



15-3033
0.8 x 3.5 mm



15-3034
0.8 x 3.5 mm

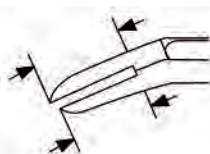

80 mm



15-3033-15-3034
McGee



Micro Ear Forceps



M.F.ELAHI MEDICAL CO
SERVING WORLDWIDE SURGICAL INSTRUMENTS



15-3035

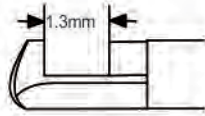

15-3036

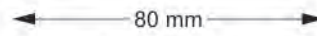

15-3035-15-3036
House-Dieter



15-3037

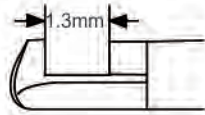

15-3038

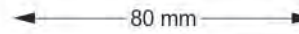

15-3037-15-3038
House-Dieter

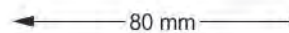
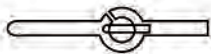

15-3039
Fuller



Micro Ear Hooks, Micro Ear Needles,
Micro Ear Knives, Ear Curettes



M.F.ELAHI MEDICAL CO
SERVING WORLDWIDE SURGICAL INSTRUMENTS



Ear Curettes, Ear Scoop,
Foreign Body Instruments



M.F.ELAHI MEDICAL CO
SERVING WORLDWIDE SURGICAL INSTRUMENTS

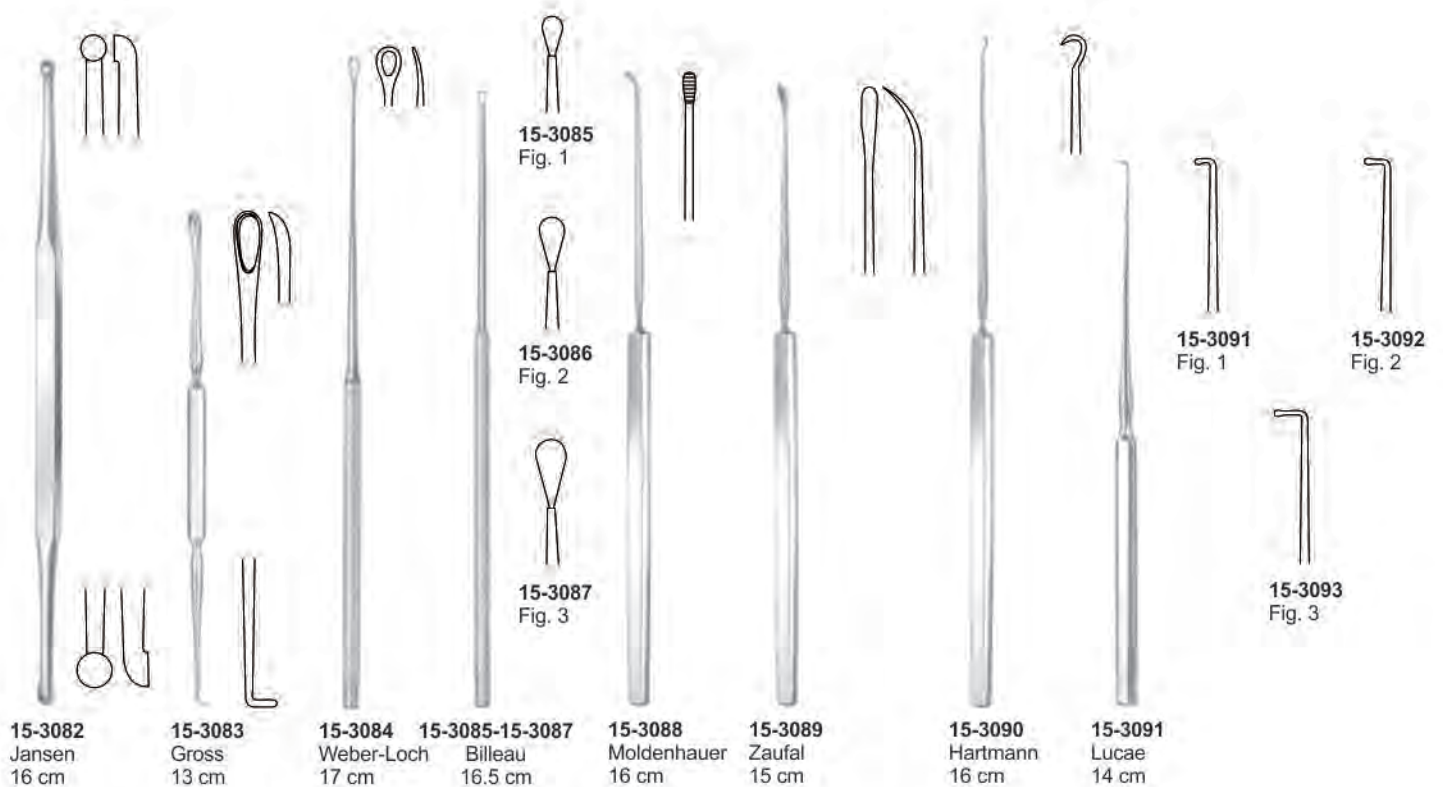
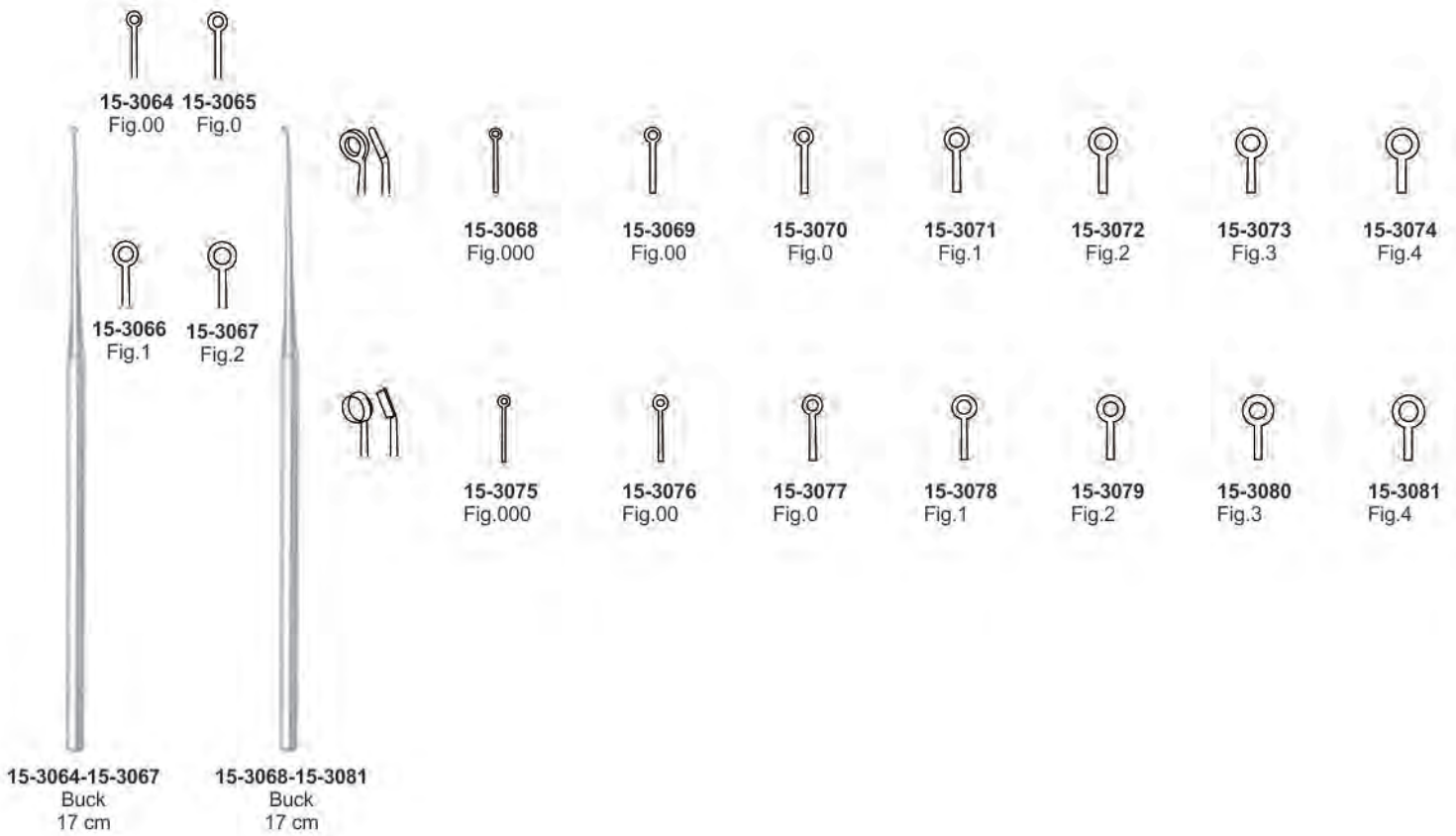

Ear Hooklet, Tympanum Needles, Ear Periosteal Elevators, Ear Scoop



M.F.ELAHI MEDICAL CO
SERVING WORLDWIDE SURGICAL INSTRUMENTS



15-3094
Fig. 1



15-3095
Fig. 2



15-3096
Fig. 3



15-3097
Fig. 4



15-3098
Fig. 5



15-3099
Fig. 6



15-3100
Fig. 7

15-3094-15-3100
Wagener
14 cm



15-3101-15-3102
Day
17 cm



15-3101



15-3102



15-3103
Poltzer
17.5 cm



15-3104
Poltzer
15.5 cm



15-3105
Poltzer
16 cm



15-3106
Lucae
18 cm



15-3107
Lucae
17.5 cm



15-3108
Lempert
20.5 cm



15-3109
6 mm



15-3110
Lempert
18 cm



15-3111
6 mm



15-3112-15-3116
Lempert
21.5 cm

15-3112
Fig. 1

15-3113
Fig. 2

15-3114
Fig. 3

15-3115
Fig. 4

15-3116
Fig. 5



Nasal Specula

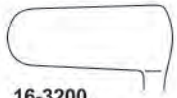

16-3200
Fig. 1
21.0 x 9.5 mm

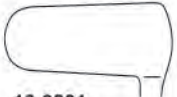

16-3201
Fig. 2
21.0 x 10.5 mm



16-3202
Fig. 3
21.0 x 11.5 mm



16-3200-16-3202
Goldsmith (Thudichum)



16-3203
Fig. 1
35 mm

16-3204
Fig. 2
50 mm

16-3205
Fig. 3
75 mm



16-3203-16-3205
ST. Clair Thomson

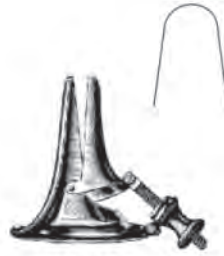

16-3206
Vacher



16-3207
Fig. 1



16-3208
Fig. 2



16-3209
Fig. 3



16-3207-16-3209
Voltolini



16-3210-A
Fig.1



16-3210-B
Fig.2



16-3210-C
Fig.3



16-3210
Hartmann



16-3211
Fig. 1
27 mm

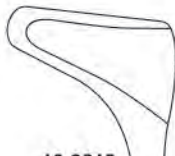

16-3212
Fig. 2
31 mm



16-3213
Fig. 3
35 mm



16-3211-16-3213
Hartmann-Halle
16 cm



16-3214
Schwarz
14 cm



16-3215
Vienna
14.5 cm

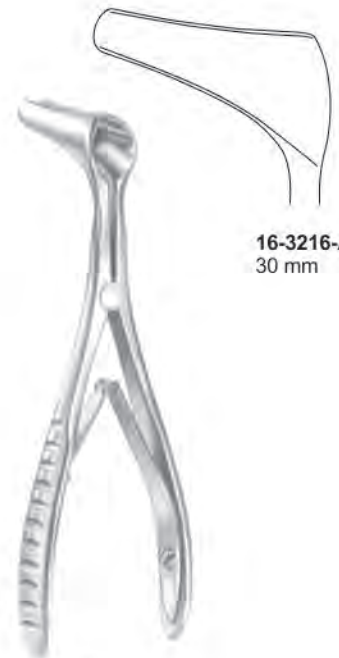

16-3216
Mod. Wien
13.5 cm

16-3216-A
30 mm



Nasal Specula



M.F.ELAHI MEDICAL CO
SERVING WORLDWIDE SURGICAL INSTRUMENTS



16-3218
17 mm



16-3220
17 mm



16-3222
16 mm



16-3223-16-3226
Killian

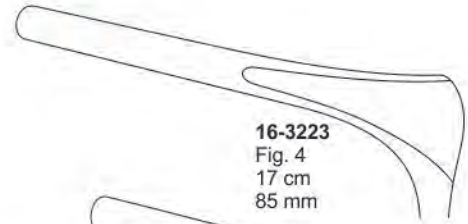

16-3223
Fig. 4
17 cm
85 mm

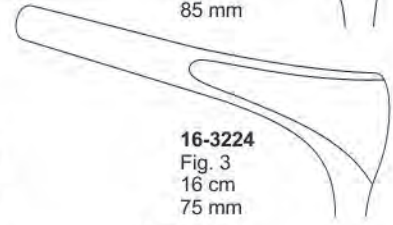

16-3224
Fig. 3
16 cm
75 mm

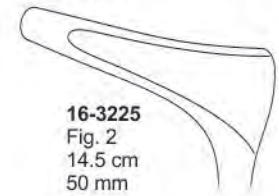

16-3225
Fig. 2
14.5 cm
50 mm

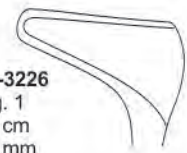

16-3226
Fig. 1
14 cm
35 mm

16-3217
Martin
13 cm

16-3219
Martin
13 cm

16-3221
Tieck-Halle
13 cm

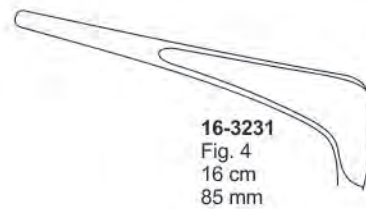

16-3231
Fig. 4
16 cm
85 mm



16-3227-16-3230
Killian
13 cm

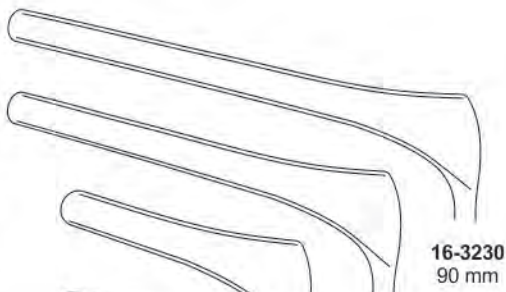

16-3230
90 mm

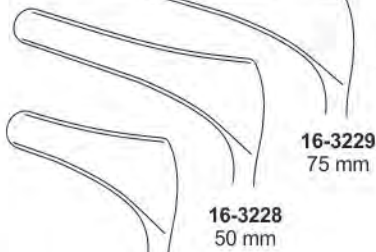

16-3229
75 mm

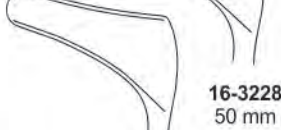

16-3228
50 mm

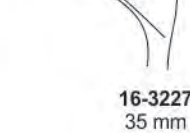

16-3227
35 mm



16-3231-16-3234
Cottle
13 cm

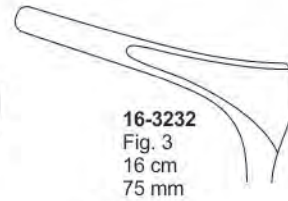

16-3232
Fig. 3
16 cm
75 mm

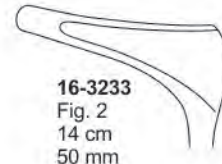

16-3233
Fig. 2
14 cm
50 mm



16-3234
Fig. 1
13.5 cm
35 mm



16-3235
Cottle (with side screw)
13 cm



Nasal Specula, Polypus Snare, Septum Compression Forceps



M.F. ELAHI MEDICAL CO
SERVING WORLDWIDE SURGICAL INSTRUMENTS

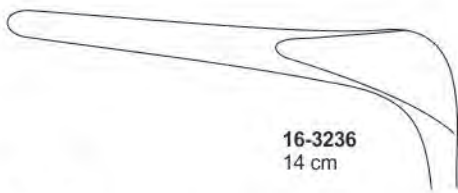

16-3236
14 cm



16-3238
Yankauer
19 cm



16-3240
Ø 3 mm

16-3239
Krause
26 cm



16-3242
Ø 3 mm

16-3241
Krause-Voss
26 cm



16-3243
Ø 0.3 mm
Ø 0.4 mm

16-3244
10.5 cm



16-3236-16-3237
Cottle

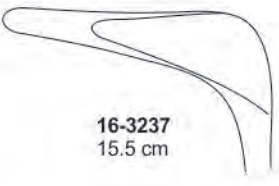

16-3237
15.5 cm



16-3245
Killian
17 cm

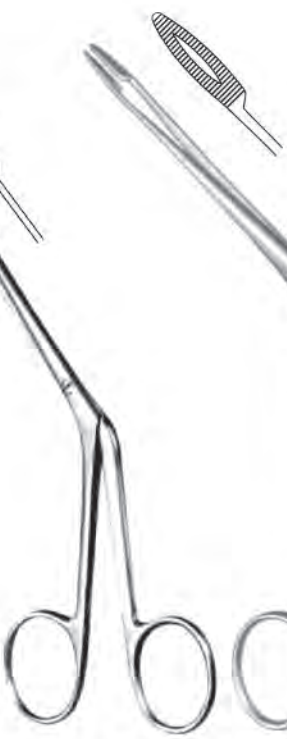

16-3246
Littauer
18 cm



16-3247
Hartmann
18.5 cm



16-3248
Graig
16 cm



16-3249-16-3250
15.5 cm

16-3249

16-3250



Nasal Polypus and Septum Compression Forceps



M.F. ELAHI MEDICAL CO
SERVING WORLDWIDE SURGICAL INSTRUMENTS

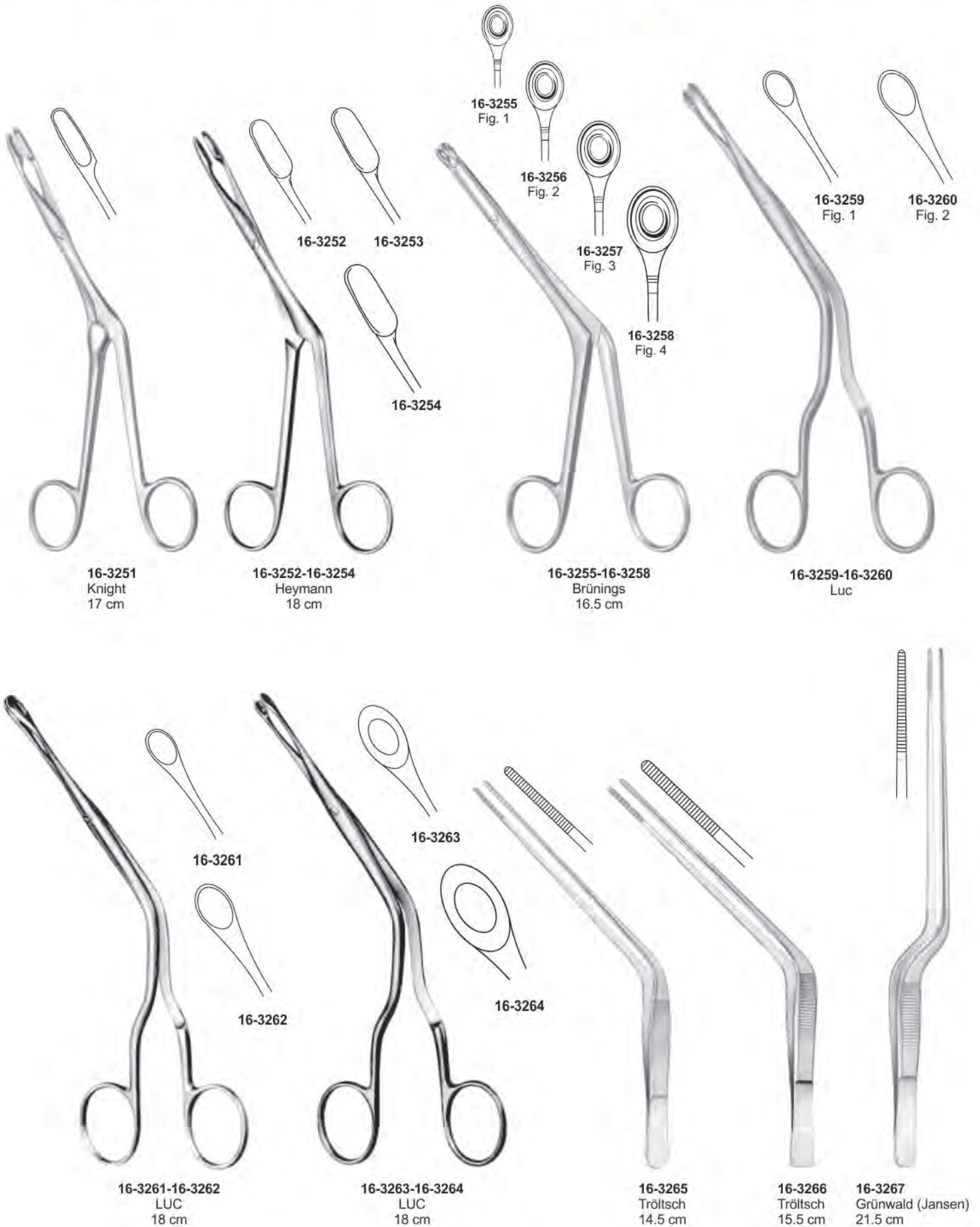

Nasal Polypus and Septum Compression
Forceps, Ethmoid Bone Forceps



M.F. ELAHI MEDICAL CO
SERVING WORLDWIDE SURGICAL INSTRUMENTS

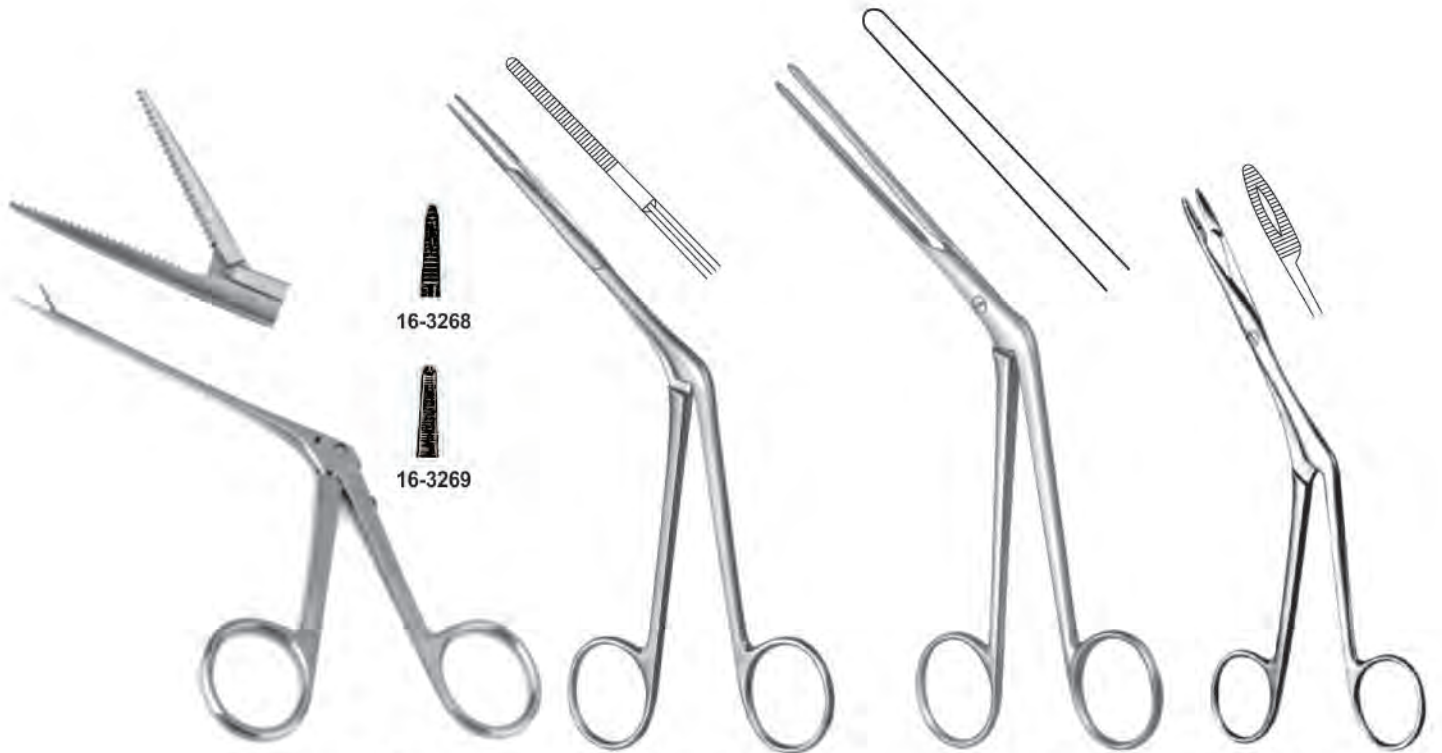

16-3268-16-3269
Noyes
14.5 cm

16-3270
Westmacott
20 cm

16-3271
Lubet-Barbon
18.5 cm

16-3272
Heymann-Knight
18 cm



16-3275



16-3276

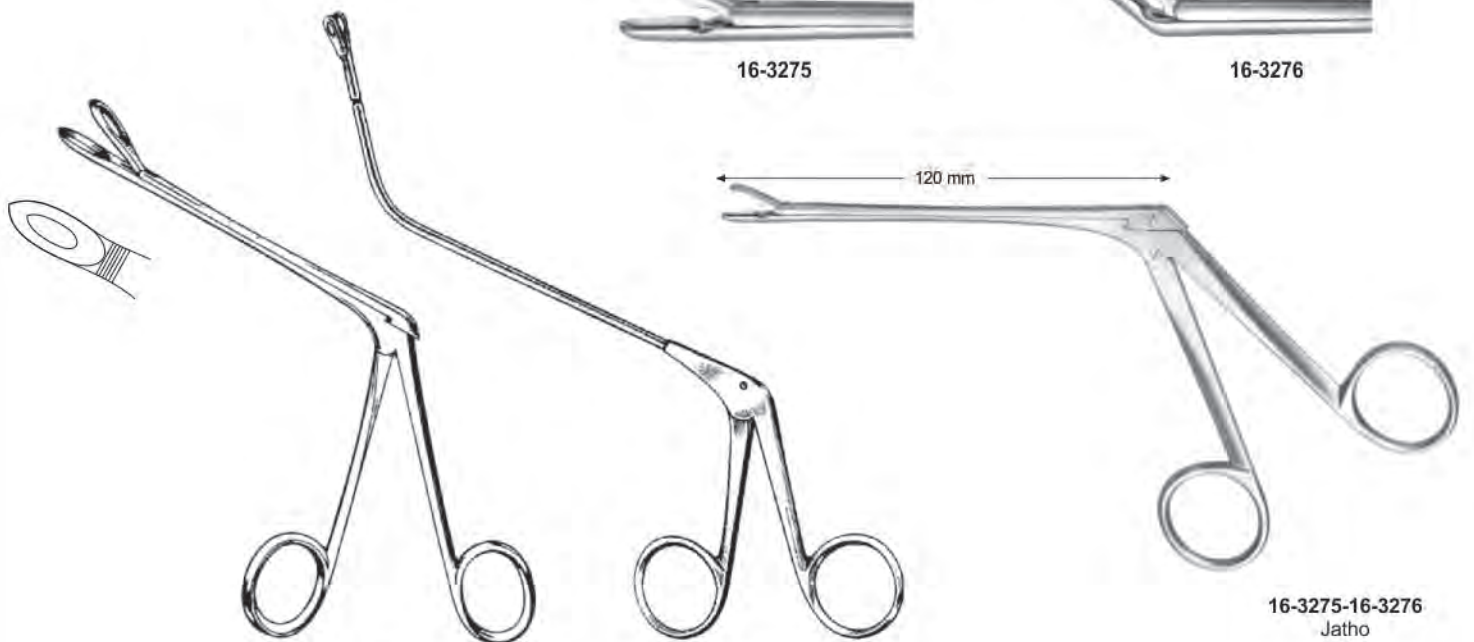

16-3273
Henckel
20 cm

16-3274
Jatho

16-3275-16-3276
Jatho





Ethmoid Bone Forceps

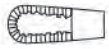

16-3277
Watson-Williams



16-3278



16-3279
Weil

120 mm



16-3277-16-3279

120 mm



16-3280-16-3281
Strycken

16-3280
Fig. 1
0.9 mm

16-3281
Fig. 2
1.2 mm



125 mm



16-3282-16-3286
Weil-Blakesley



16-3282
Fig. 1
3.0 mm



16-3283
Fig. 2
3.5 mm



16-3284
Fig. 3
4.5 mm



16-3285
Fig. 4
5.5 mm



16-3286
Fig. 5
6.0 mm





Ethmoid Bone Forceps



16-3287
Hajek
19 cm
120 mm



16-3288
Hartmann
19 cm
120 mm

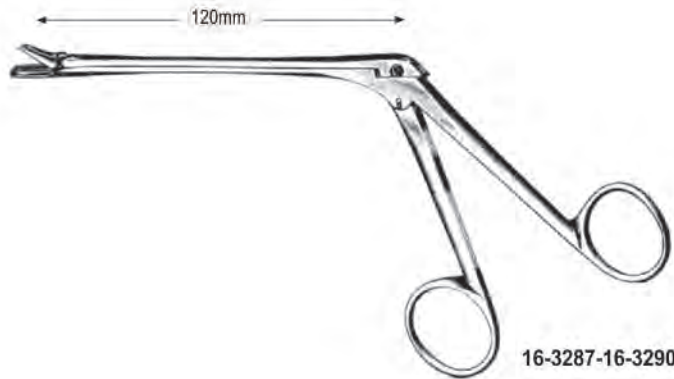

16-3287-16-3290



16-3289
Schmedenschmeden
19 cm
120 mm



16-3290
Myles
19 cm
120 mm

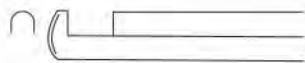

16-3291
3.0 x 3.0 mm

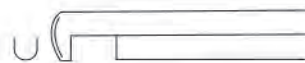

16-3292
3.0 x 3.0 mm

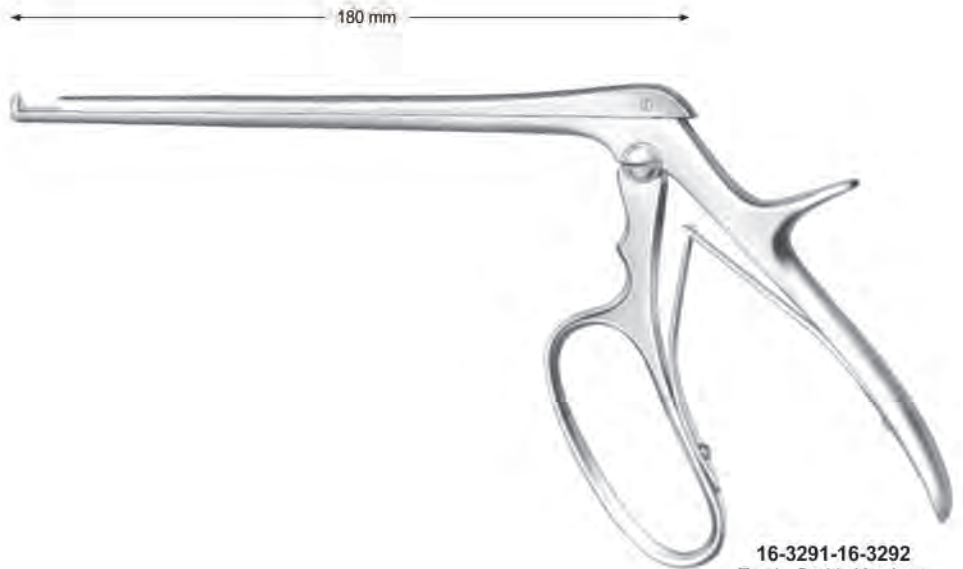

16-3291-16-3292
Ferris-Smith-Kerrison

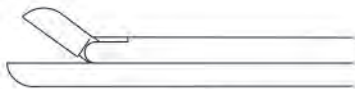

16-3293

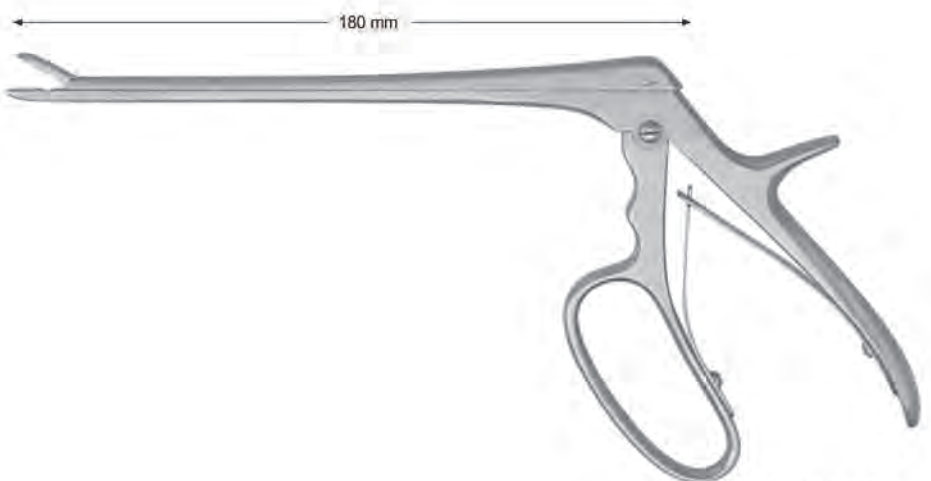

16-3293-16-3295

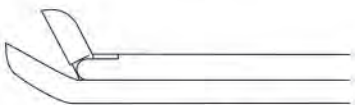

16-3294

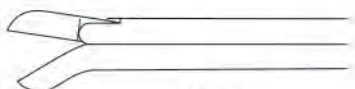

16-3295





Osteotomes, Chisels

16-3296 4 mm	16-3297 7 mm	16-3301 6 mm	16-3303 16 mm	16-3304 2 mm	16-3305 4 mm	16-3310 6 mm		16-3306 7 mm		16-3307 9 mm		16-3308 12 mm			
	16-3298 9 mm		16-3299 12 mm	16-3296-16-3299 Cottle 18.5 cm	16-3300 Cottle 18.5 cm	16-3302 Cottle 18.5 cm	16-3304-16-3308 Cottle 18.5 cm	16-3309 Cottle 18.5 cm							
		16-3312 16 mm			16-3313 4 mm		16-3314 5 mm		16-3317 10 mm		16-3318 12 mm		16-3321 7 mm		16-3322 8 mm
	16-3315 6 mm		16-3316 7 mm		16-3319 14 mm		16-3320 16 mm		16-3323 10 mm		16-3324 12 mm				
16-3311 Cottle 18.5 cm	16-3313-16-3316 Fomon 16 cm	16-3317-16-3320 Cinelli 16 cm	16-3321-16-3324 Sheehan 16 cm												



Rhinoplastic Chisels, Chisels, Cartilage Crusher



M.F.ELAHI MEDICAL CO
SERVING WORLDWIDE SURGICAL INSTRUMENTS

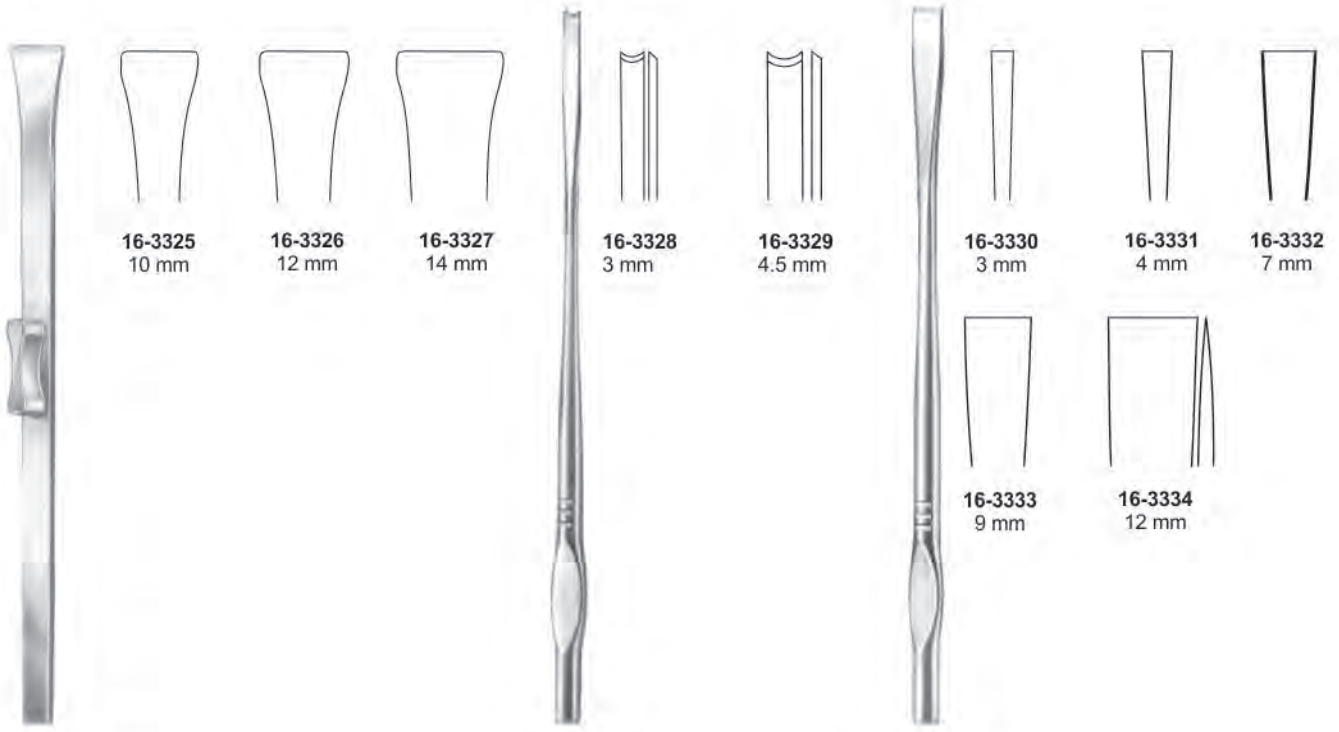

16-3325
10 mm

16-3326
12 mm

16-3327
14 mm

16-3328
3 mm

16-3329
4.5 mm

16-3330
3 mm

16-3331
4 mm

16-3332
7 mm

16-3333
9 mm

16-3334
12 mm

16-3325-16-3327
Rubin
18.5 cm

16-3328-16-3329
Walter
19 cm

16-3330-16-3334
Walter
19 cm



16-3335
Cottle
12 cm



16-3336
Cottle
7 cm



16-3337
Cottle
65 x 30 x 30 mm





Glabella Rasps, Nasal Rasps

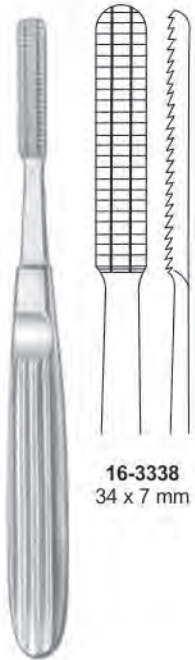

16-3338
34 x 7 mm

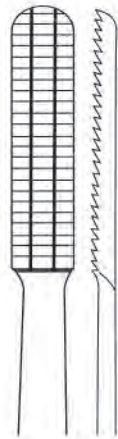

16-3339
34 x 7 mm



16-3340
60 x 8 mm

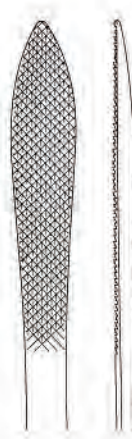

16-3341
45 x 9 mm



16-3343
30 x 8 mm

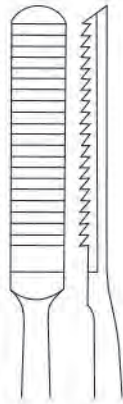

16-3338-16-3339
Maltz
17 cm

16-3340-16-3341
Joseph
16 cm

16-3342
Cottle
21 cm

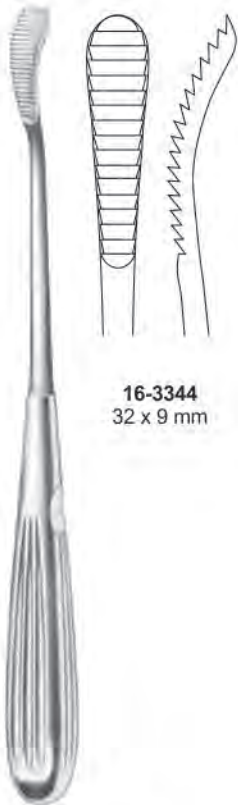

16-3344
32 x 9 mm

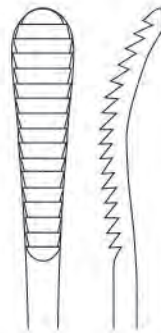

16-3345
32 x 9 mm



16-3346
15 x 8 mm

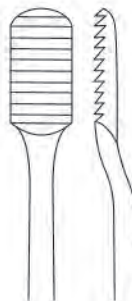

16-3347
15 x 8 mm



16-3348
Fomon
21 cm

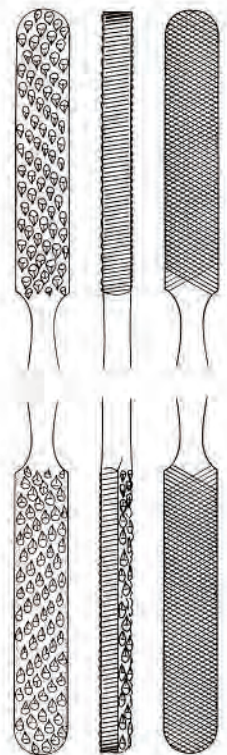

16-3344-16-3345
Aufrecht
21 cm

16-3346-16-3347
Lewis
19 cm



Nasal Hooklets, Alar Hooklets, Mucosa Hooklet



M.F.ELAHI MEDICAL CO
SERVING WORLDWIDE SURGICAL INSTRUMENTS

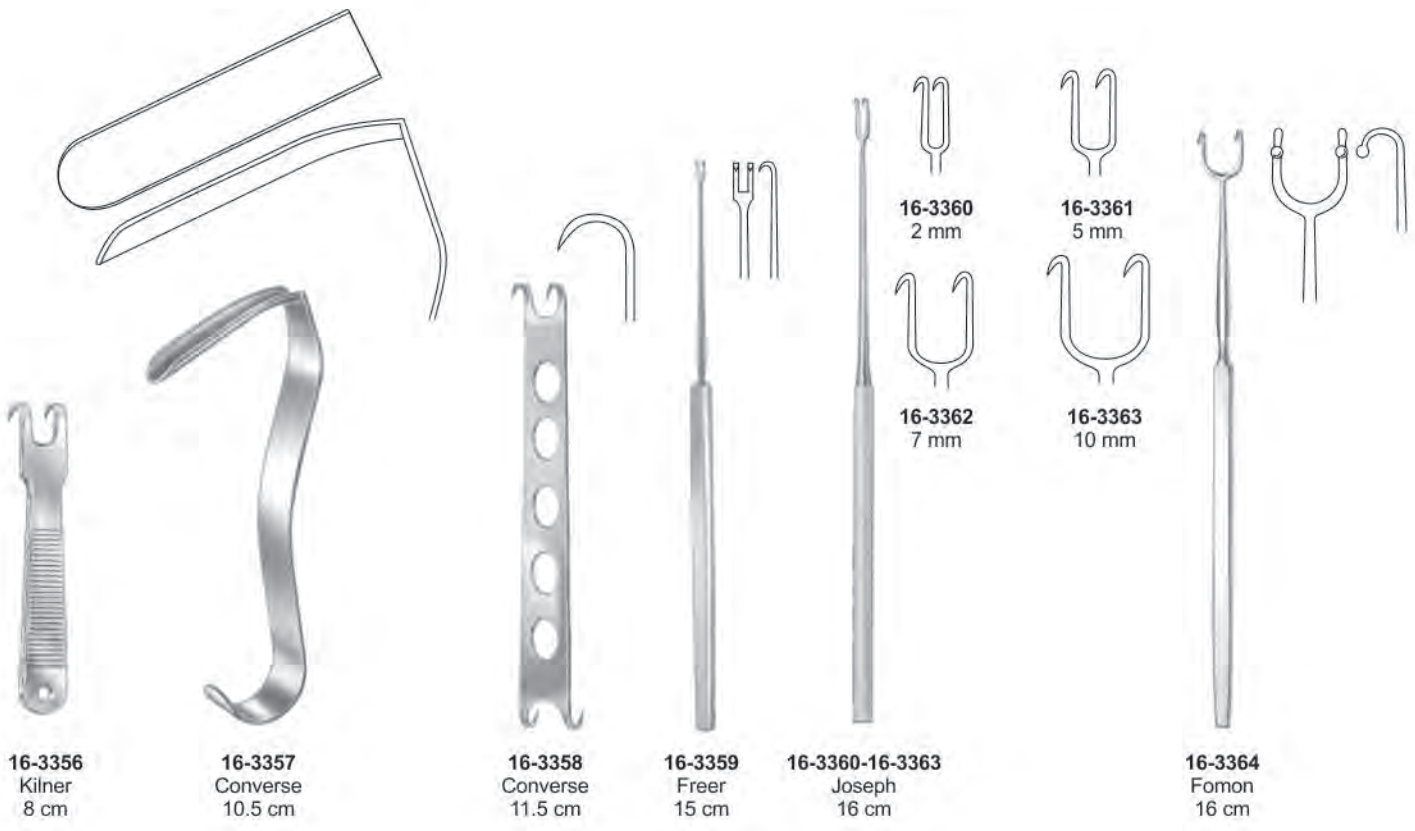
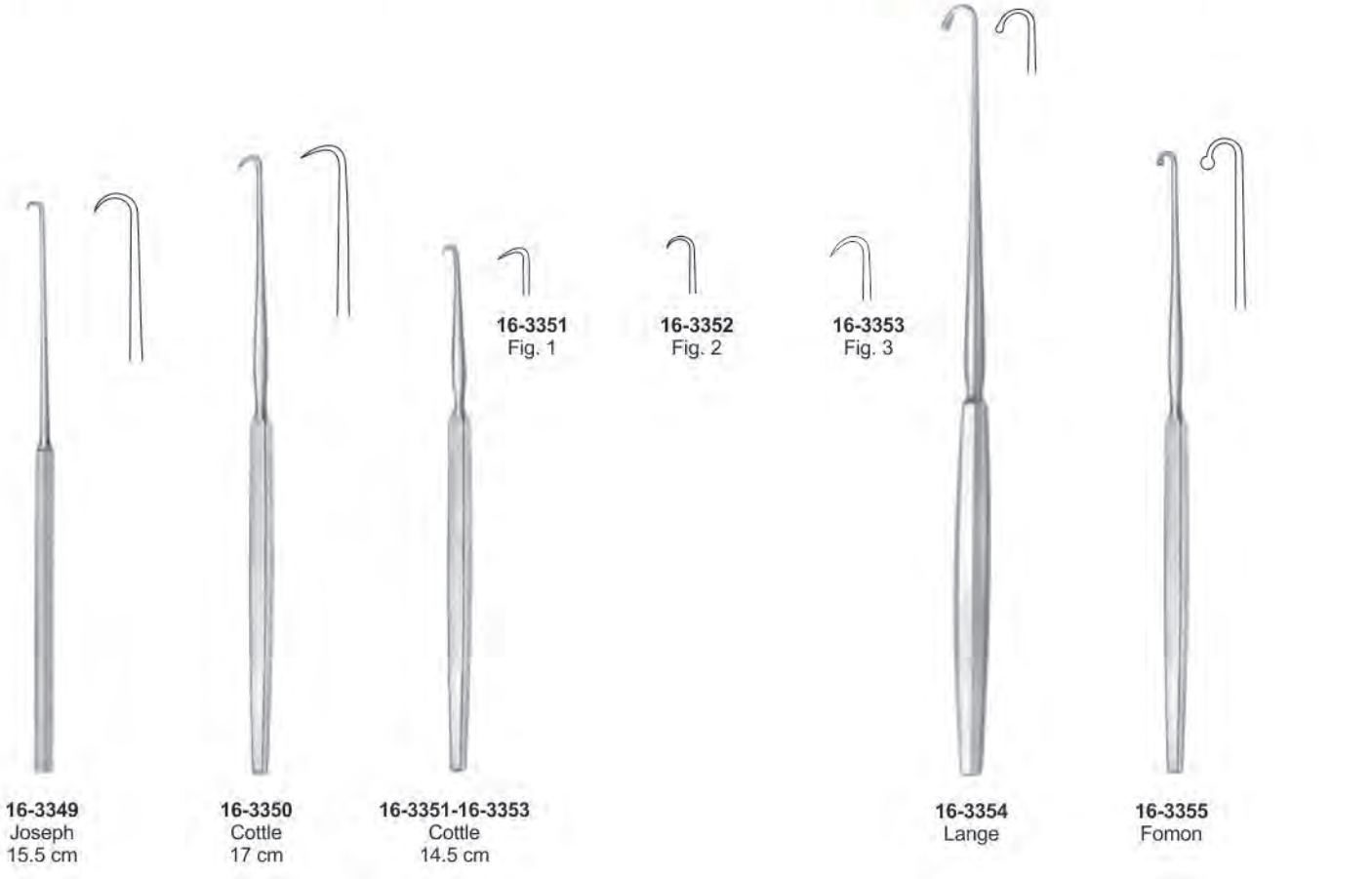



Nasal Retractors, Septum Forceps, Septum Straightening Forceps Skin Grasping Forceps



16-3365
Neivert
17 cm



16-3366
Neivert
14 cm



16-3367
Kressner
22 cm



16-3368-16-3370
Cottle-Walsham
23 cm



16-3368



16-3369



16-3370

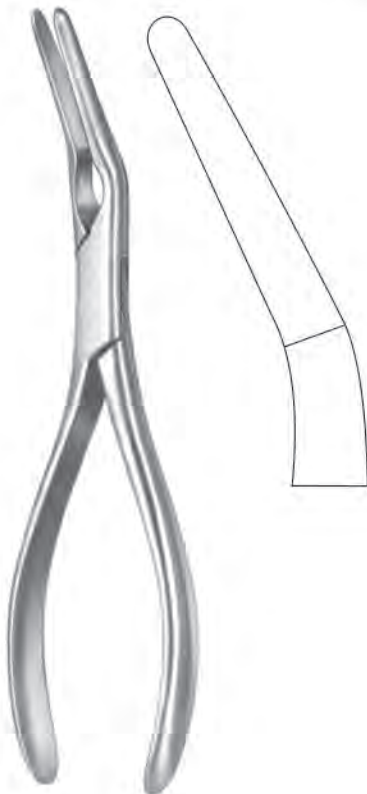

16-3371
Asch
22.5 cm



16-3372
Alach
15.5 cm



16-3373
Ogura
11 cm

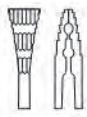

16-3374
4 mm



16-3375
Cottle
11 cm

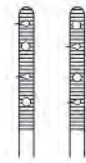

16-3376
1.7 mm



16-3377
Cottle
11 cm

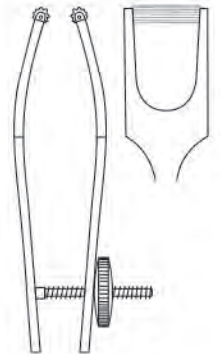

16-3378
12 mm



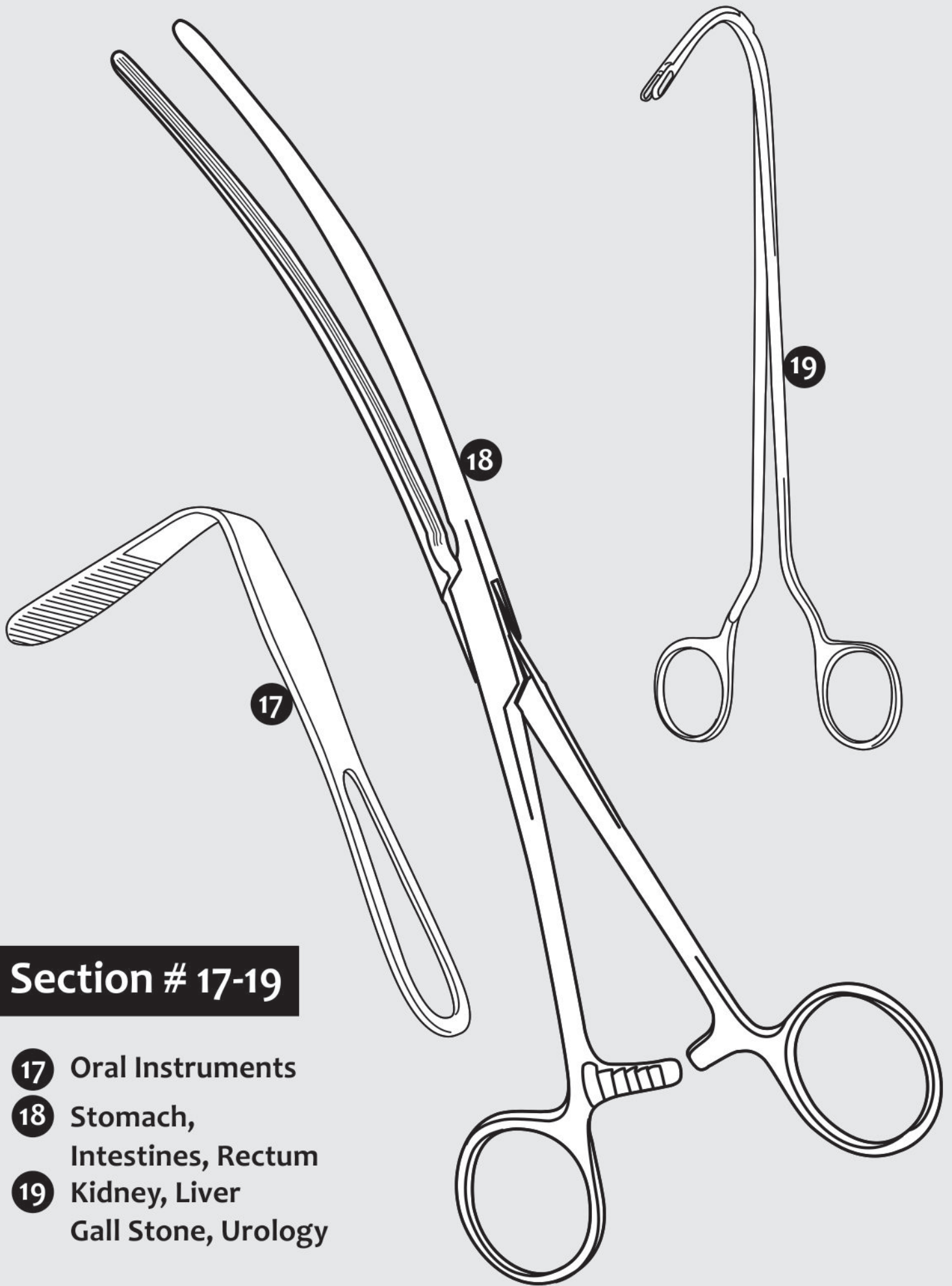

Section # 17-19

- 17 Oral Instruments
- 18 Stomach, Intestines, Rectum
- 19 Kidney, Liver Gall Stone, Urology



Finger Protector, Mouth Gags



17-3401
Adams



17-3402
Pitha
28 x 30 mm



17-3403
Langenbeck
Ø 26 / 20 mm



17-3404
Mauder
9.5 cm



17-3405
Heister
13 cm



17-3406
Obwegeser
11 cm



17-3407
Molt
11 cm



17-3408
Molt
13 cm



17-3409
Denhart
13 cm



17-3410
FERGUSON-ACKLAND
Mouth gag
Size: 145 mm



17-3411-17-3412
Rosser-König

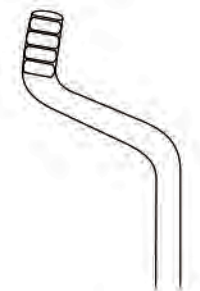

17-3411
16 cm

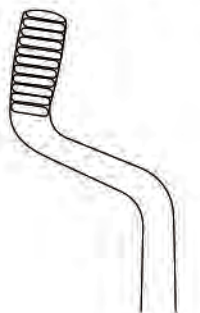

17-3412
19 cm

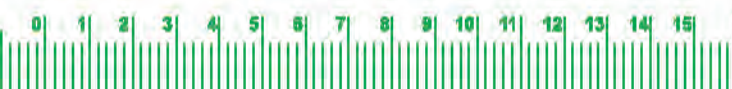

Mouth Gags



M.F. ELAHI MEDICAL CO
SERVING WORLDWIDE SURGICAL INSTRUMENTS



17-3413
Kilner-Doughty



17-3414-17-3416
Kilner-Doughty
14.5 cm



17-3414
Fig. 1
68 x 30 mm



17-3415
Fig. 2
77 x 34 mm



17-3416
Fig. 3
82 x 39 mm



17-3417-17-3419
Kilner-Doughty
14.5 cm



17-3417
Fig. 1
68 x 30 mm



17-3418
Fig. 2
77 x 34 mm



17-3419
Fig. 3
82 x 39 mm



17-3420-17-3422
Neukam



17-3420
Fig. 1



17-3421
Fig. 2



17-3422
Fig. 3





Mouth Gags



17-3423
Davis-Boyle



17-3424-17-3427
Fig. 1
110 x 28 mm



17-3424
Fig. 2
95 x 27 mm



17-3425
Fig. 3
80 x 27 mm



17-3426
Fig. 4
65 x 26 mm



17-3427
Fig. 5
30 x 20 mm



17-3428
McIvor



17-3429
Fig. 1
100 x 25 mm



17-3430
Fig. 2
85 x 25 mm



17-3431
Fig. 3
75 x 25 mm



Mouth Gags, Lip and Cheek Retractors



M.F.ELAHI MEDICAL CO
SERVING WORLDWIDE SURGICAL INSTRUMENTS

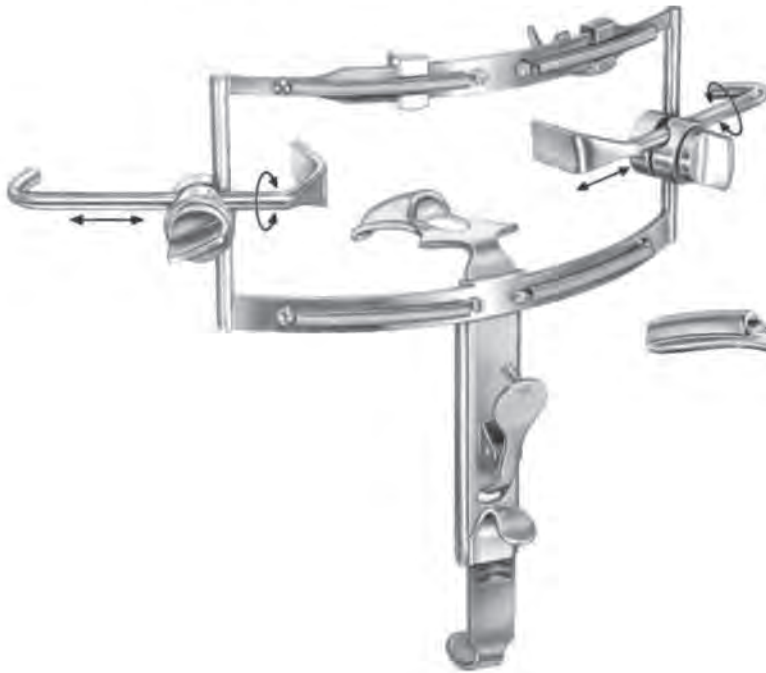

17-3432
Dingmann



17-3433
Fig. 1
62 x 26 mm



17-3434
Fig. 2
65 x 30 mm



17-3435
Fig. 3
78 x 32 mm



17-3437-17-3439
Oringer

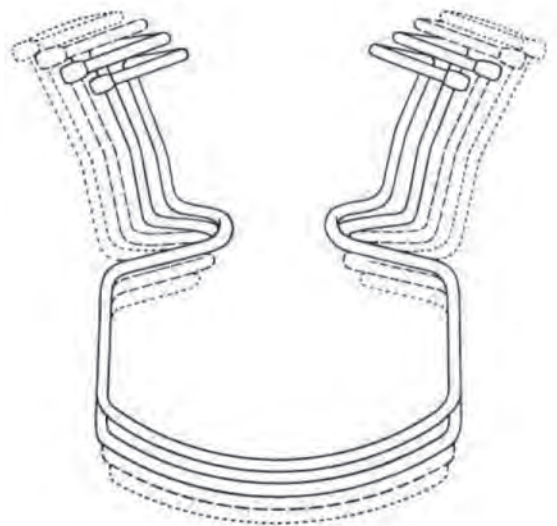

17-3437
Fig. 1
10 cm

17-3438
Fig. 2
10.5 cm

17-3439
Fig. 3
11 cm



17-3436
Jennings
10.5 cm, 12.5 cm
14.5 cm, 16.5 cm



Lip and Cheek Retractors, Tongue Depressors



M.F.ELAHI MEDICAL CO
SERVING WORLDWIDE SURGICAL INSTRUMENTS



17-3440
Martin-Simplex
10.5 cm

17-3441
14 cm

17-3442
Sternberg
14 cm



17-3443
Obwegeser
12 cm



17-3444
Bishop
13.5 cm



17-3446
ANDREW
Size: 110 mm

17-3445
Cawood-Minnesota
15.5 cm



17-3447
Cawood-Minnesota
14.5 cm

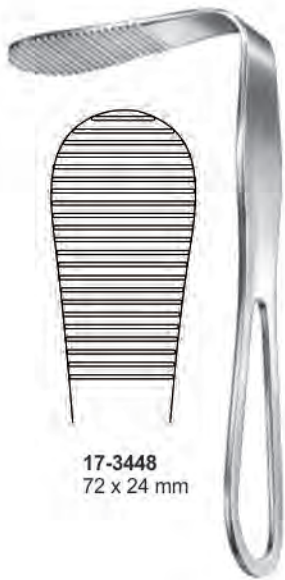

17-3448
72 x 24 mm

17-3449
Hartmann
15 cm

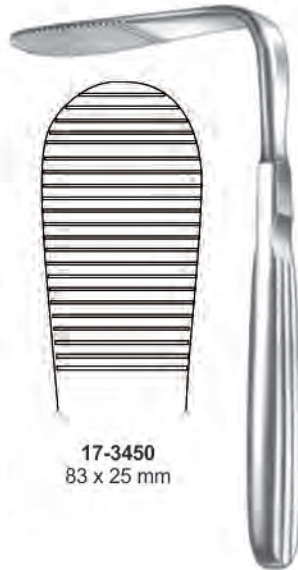

17-3450
83 x 25 mm

17-3451
Tobold
15 cm

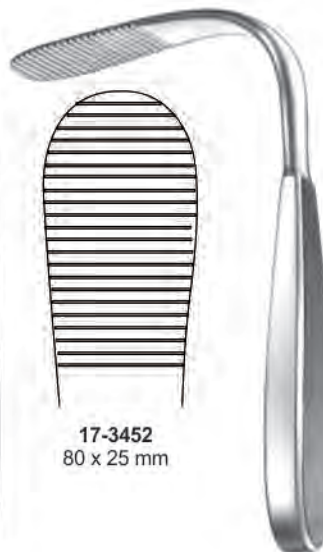

17-3452
80 x 25 mm

17-3453
Tobold
16 cm

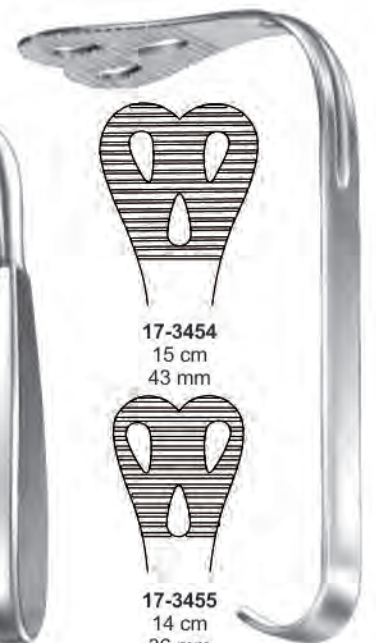

17-3454
15 cm
43 mm

17-3455
14 cm
36 mm

17-3454-17-3455
Wieder



Tongue Spatulas, Tongue Holding Forceps



M.F.ELAHI MEDICAL CO
SERVING WORLDWIDE SURGICAL INSTRUMENTS



17-3456
19 cm



17-3457
15 cm



17-3458
FRENZEL
Size: 165 mm



17-3459
Doyen



17-3460
13 cm
23 x 30 mm

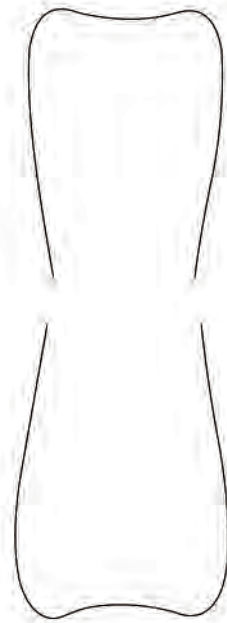

17-3461
16 cm
30 x 33 mm



17-3462
Brünings
19 cm



17-3463
14.5 cm



17-3464
14 cm



17-3465
Collin
17 cm

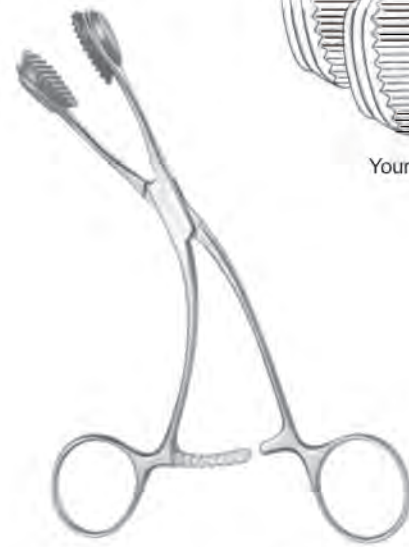

17-3466
Young
15 cm



Young



Extra Oral Retractors



M.F.ELAHI MEDICAL CO
SERVING WORLDWIDE SURGICAL INSTRUMENTS



17-3467
22 cm

17-3468
Eckelt
21 cm



17-3469
25 cm

17-3470
Eckelt
25 cm



17-3471
23 cm
25.5 mm

17-3472
26 cm
25.5 mm



17-3473
21 cm

17-3474
21 cm

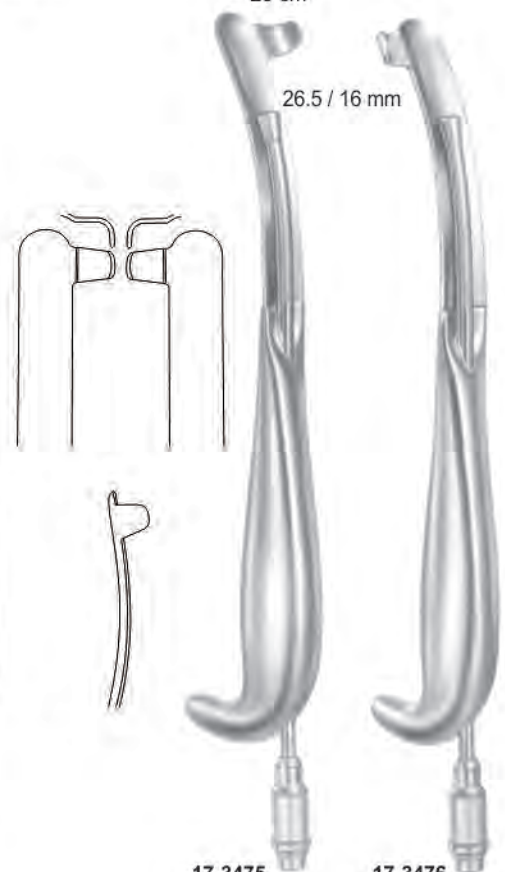

17-3475
24.5 cm

17-3476
24.5 cm



Intra Oral Retractors, Soft Tissue Retractors



M.F.ELAHI MEDICAL CO
SERVING WORLDWIDE SURGICAL INSTRUMENTS

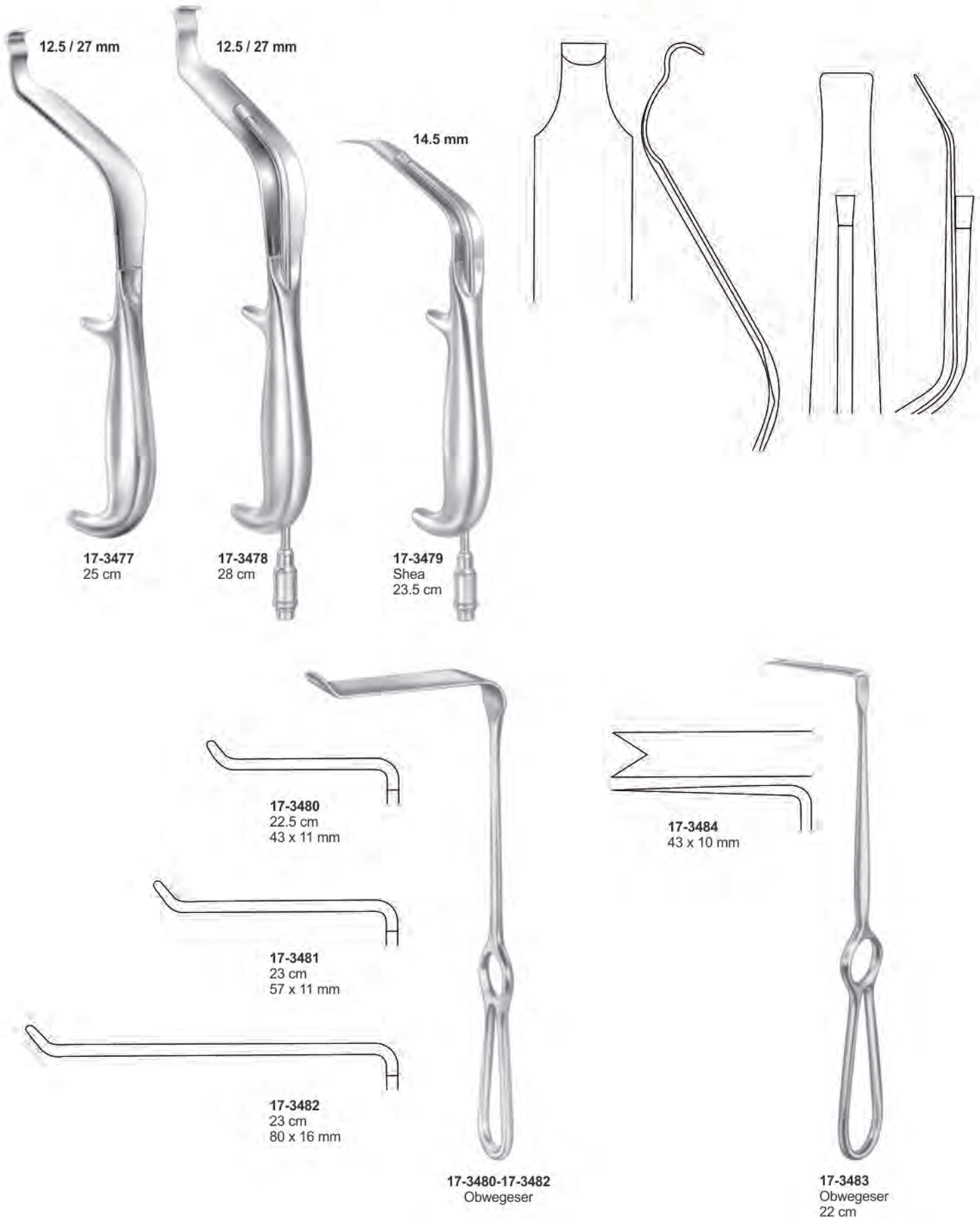

Ramus Retractors, Chin Retractor,
Channel Retractors



M.F.ELAHI MEDICAL CO
SERVING WORLDWIDE SURGICAL INSTRUMENTS

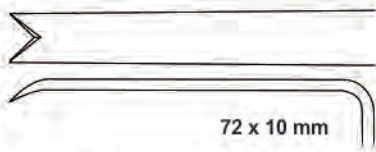

72 x 10 mm

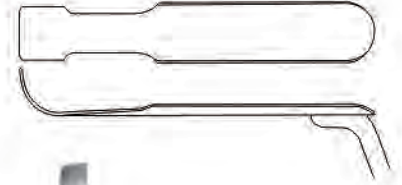
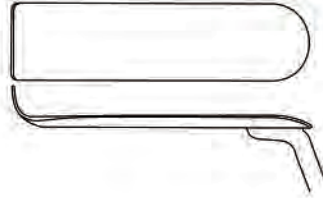

17-3485
Obwegeser
22 cm



17-3486
Obwegeser
16.5 cm



17-3487
Obwegeser
16 cm
8 mm



17-3488
Schuchardt
18 cm



17-3489
Metz
19.5 cm

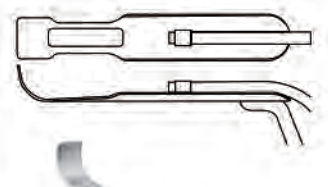
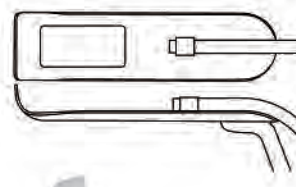
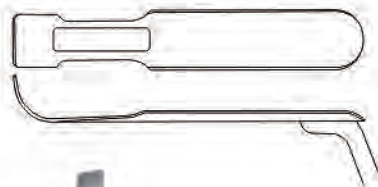
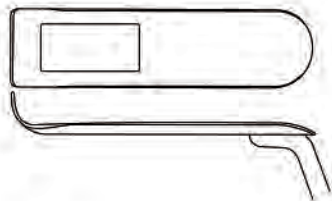

17-3490
Schuchardt-Lauer
15 cm



17-3491
Metz-Lauer
15 cm



17-3492
Schuchardt-Lauer
15 cm



17-3493
Metz-Lauer
15 cm



Progeny Retractor, Periosteal Elevators



M.F.ELAHI MEDICAL CO
SERVING WORLDWIDE SURGICAL INSTRUMENTS

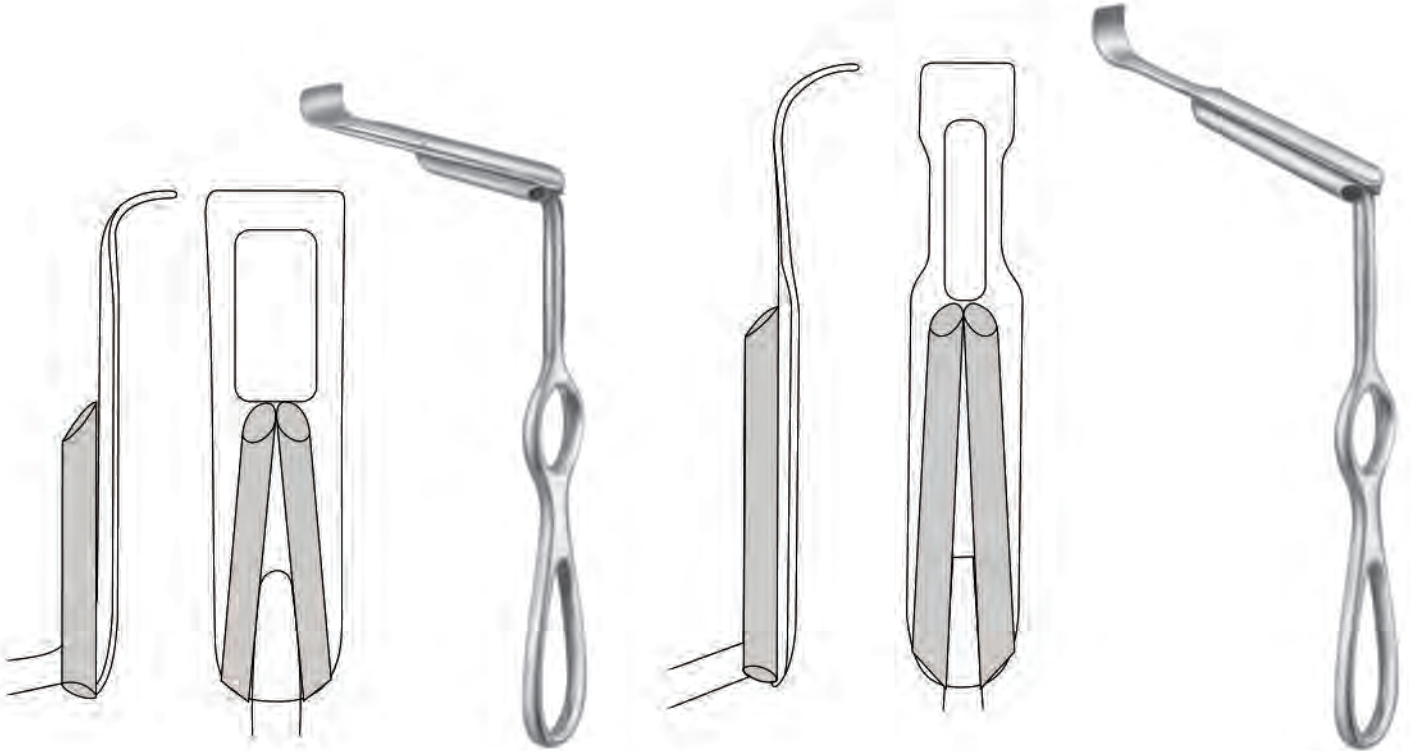

17-3494
Schuchardt-Lauer
20 cm

17-3495
Metz-Lauer
20 cm



17-3496-17-3499
Obwegeser
17.5 cm

17-3500-17-3502
Obwegeser
20 cm



Periosteal Elevators, Elevators, Osteotomes,
Wire Pushers



M.F. ELAHI MEDICAL CO
SERVING WORLDWIDE SURGICAL INSTRUMENTS



17-3503



17-3504

17-3503-17-3504
Obwegeser
17.5 cm



17-3505
Obwegeser
20.5 cm



17-3506
Obwegeser
20.5 cm



6 mm

17-3507
Obwegeser
15 cm



17-3508
17 cm



17-3509-17-3511
Rowe
L

17-3512-17-3514
Rowe
R

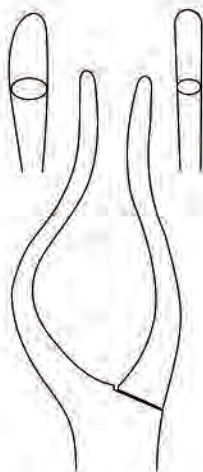

17-3509
L
17-3512
R
21.5 cm

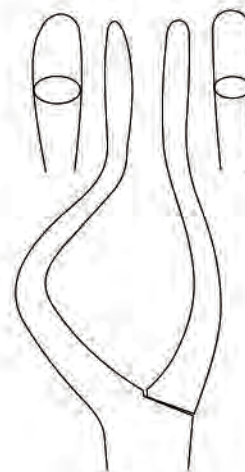

17-3510
L
17-3513
R
24 cm

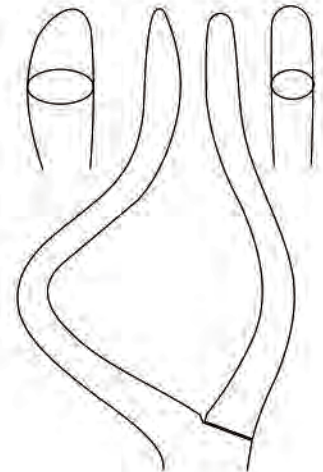

17-3511
L
17-3514
R
24.5 cm

Retractors, Bone Holding Forceps, Instruments for TMJ



M.F.ELAHI MEDICAL CO
SERVING WORLDWIDE SURGICAL INSTRUMENTS

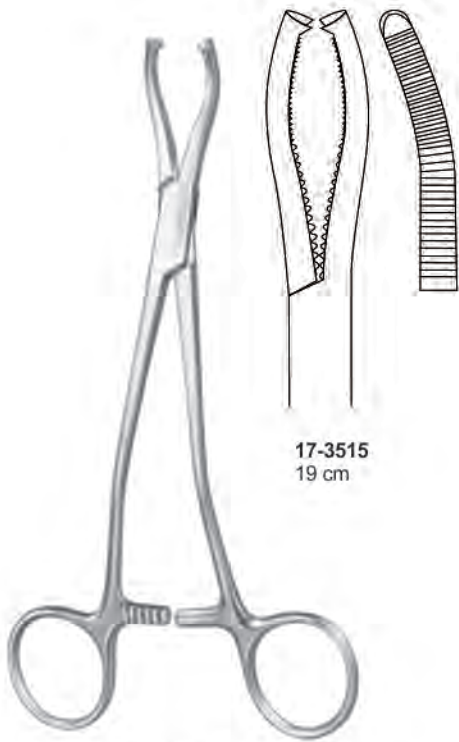

17-3515
19 cm

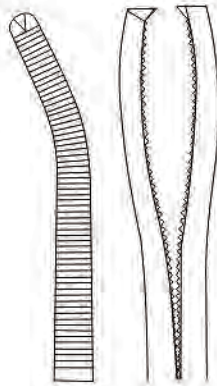

17-3516
18 cm



17-3517

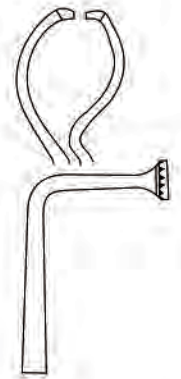

17-3518

17-3515-17-3516
Jeter-Van Sickels

17-3517-17-3518
Keen
17.5 cm



17-3519
Wolford
25 cm



17-3520
Salyer
16.5 cm



17-3521
Dolwick
16 cm

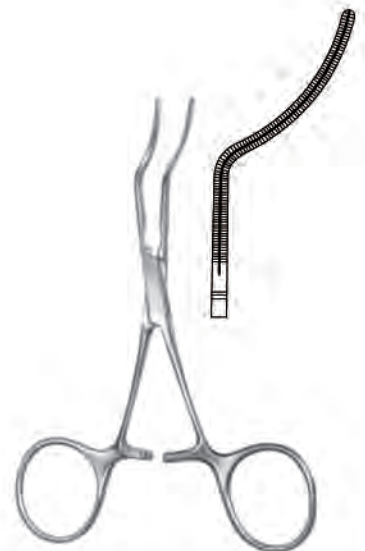

17-3522
Dolwick
12.5 cm



Instruments for TMJ



M.F.ELAHI MEDICAL CO
SERVING WORLDWIDE SURGICAL INSTRUMENTS



17-3523
Dolwick
13.5 cm



17-3524
Dolwick
14.5 cm



17-3525
Dolwick
17 cm



17-3526
Dolwick
14.5 cm



17-3527
Dolwick
22 cm



17-3528
Champy
16 cm

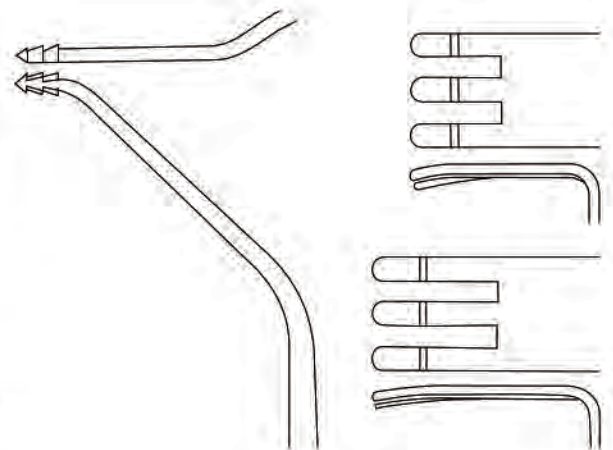

Osteotomes



M.F.ELAHI MEDICAL CO
SERVING WORLDWIDE SURGICAL INSTRUMENTS



17-3529
6 mm



17-3530
8 mm



17-3531
6 mm

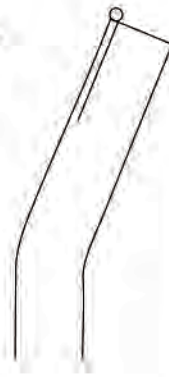

17-3532
8 mm

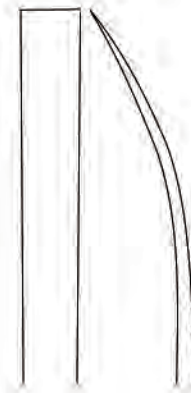

17-3533
Epker-Bauer
17.5 cm



17-3534
6 mm

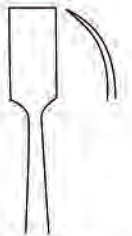

17-3535
6 mm

17-3534-17-3535
Dunn-Dautrey
17 cm

17-3529-17-3530
Bauer
20.5 cm

17-3531-17-3532
Bauer
20.5 cm



17-3536
4 mm



17-3537
6 mm

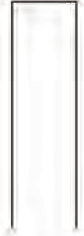

17-3538
8 mm



17-3539
10 mm



17-3540
12 mm



17-3541
14 mm

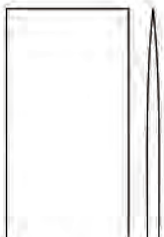

17-3542
16 mm



17-3543
4 mm



17-3545
6 mm



17-3544
8 mm

17-3543-17-3545
Dunn-Dautrey
16 cm



4 mm



17-3546
Partsch
14.5 cm

17-3536-17-3542
Dautrey-Munro
16 cm



Osteotomes, Periform Rim Retractor,
Pterygoid Osteotome, Bone Holding Forceps



M.F.ELAHI MEDICAL CO
SERVING WORLDWIDE SURGICAL INSTRUMENTS



17-3547
4 mm



17-3548
6 mm



17-3549
8 mm



17-3550
4 mm



17-3551
6 mm



17-3552
6 mm



17-3553
8 mm

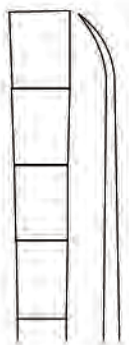

17-3547-17-3549
Epker
18 cm

17-3550-17-3551
Epker
18 cm

17-3552-17-3553
Epker
18 cm

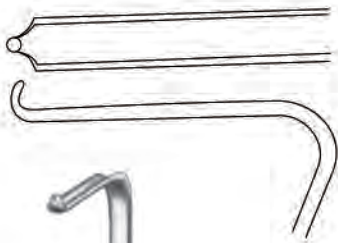

17-3554
Hargis
18.5 cm



17-3555
Hargis
22 cm



17-3556
Hargis
19 cm



9 mm



17-3558
Smith
18.5 cm



9 mm



17-3559
Smith
18.5 cm



17-3557
55 cm



Osteotomes, Periform Rim Retractor,
Pterygoid Osteotome, Bone Holding Forceps



M.F.ELAHI MEDICAL CO
SERVING WORLDWIDE SURGICAL INSTRUMENTS

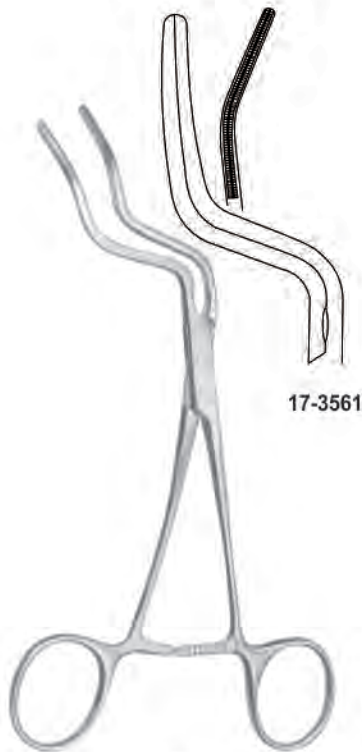

17-3561

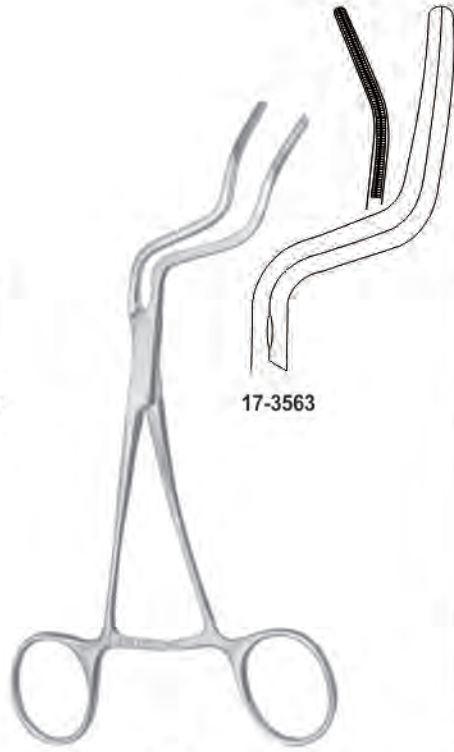

17-3562



17-3564
Terry
16.5 cm



17-3565
Steinhäuser
18.5 cm



17-3566
Steinhäuser
27 cm



17-3567
Steinhäuser
16 cm



17-3568
Steinhäuser
16 cm

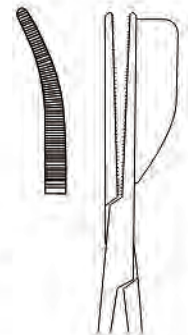

17-3569

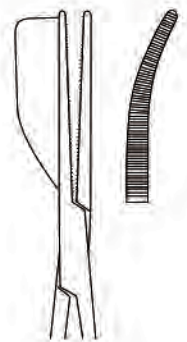

17-3570



Intestinal and Tissue Grasping Forceps



M.F.ELAHI MEDICAL CO
SERVING WORLDWIDE SURGICAL INSTRUMENTS

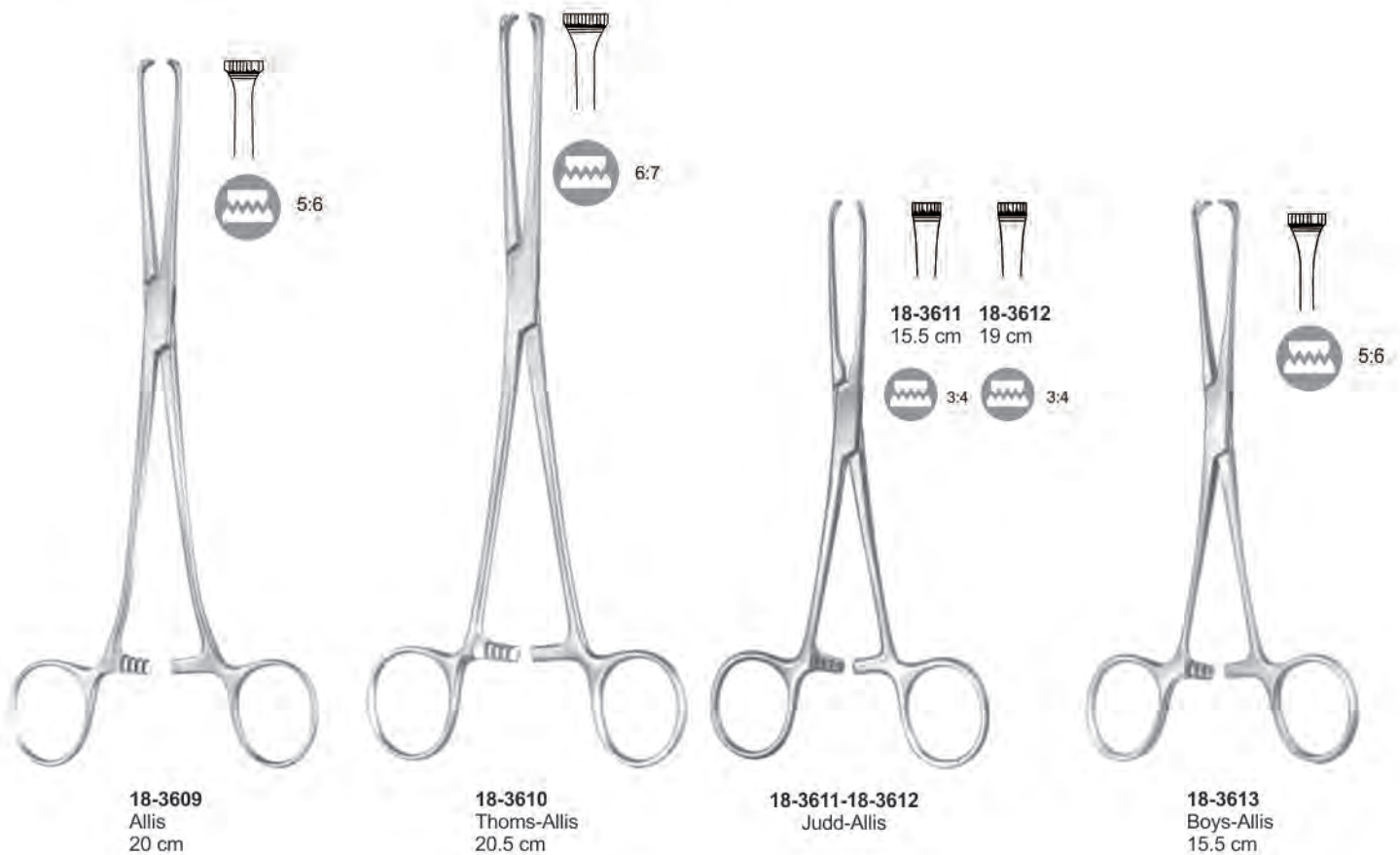
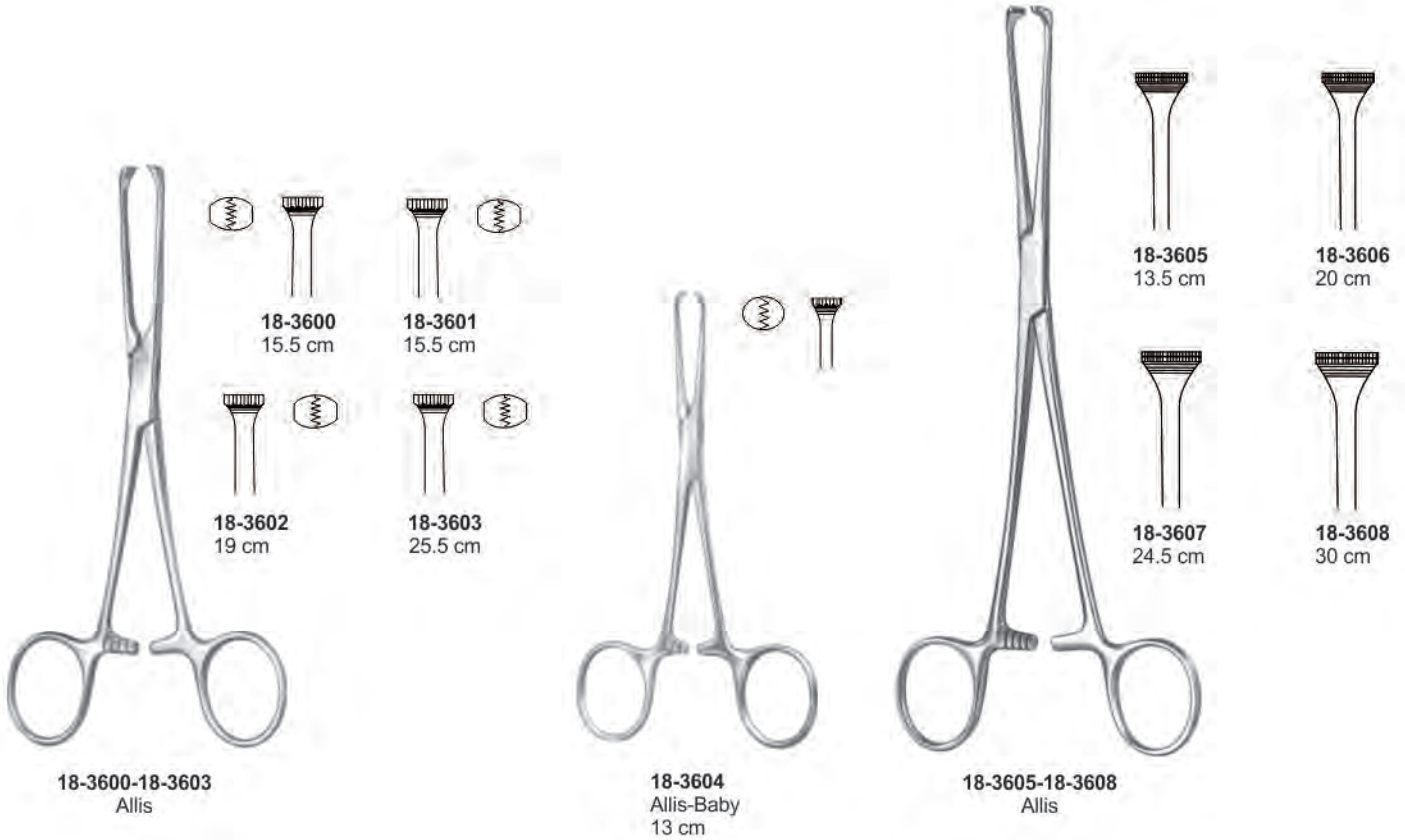

Intestinal and Tissue Grasping Forceps



M.F. ELAHI MEDICAL CO
SERVING WORLDWIDE SURGICAL INSTRUMENTS



18-3614
Allis-Adair
16 cm

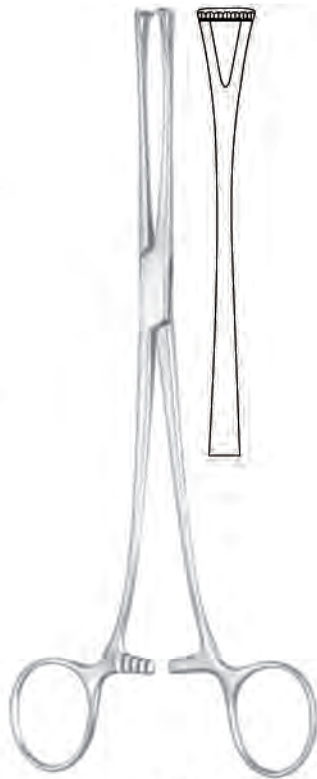

18-3615
Lockwood
20 cm

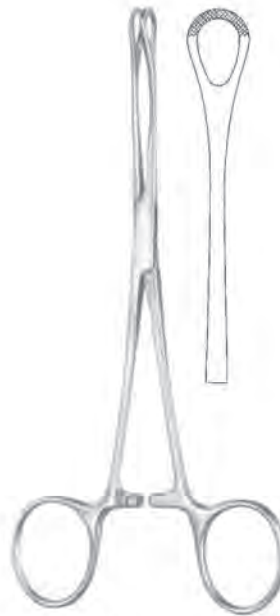

18-3616
Williams
16.5 cm



18-3617
Littlewood
18.5 cm



18-3618-18-3621
Babcock



18-3619
17.5 cm



18-3620
21 cm



18-3621
24 cm



18-3622
Babcock



18-3623
16 cm



18-3624
Baby-Babcock



18-3625
Babcock



Intestinal and Tissue Grasping Forceps

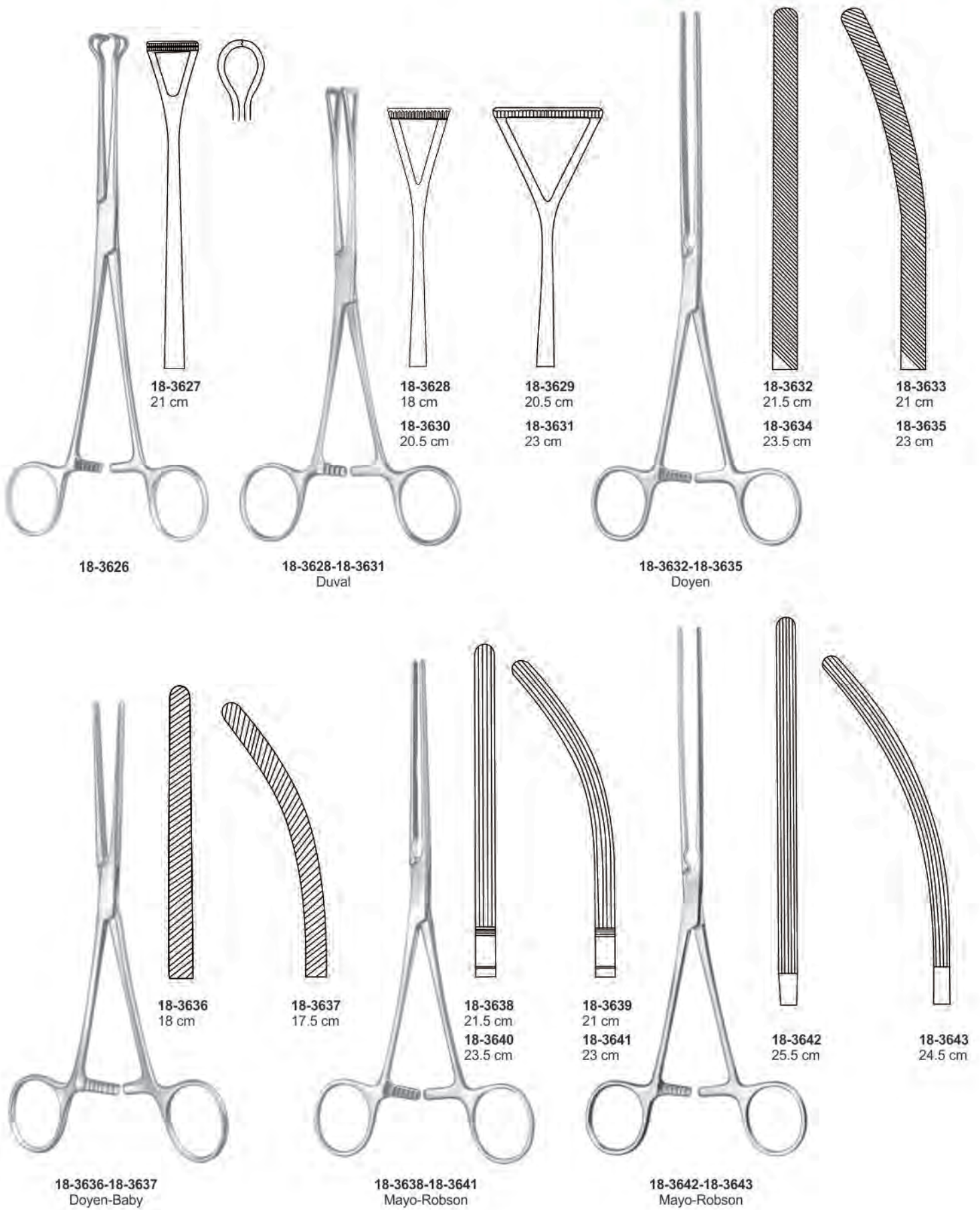

Intestinal and Tissue Grasping Forceps,
Pylorus Clamps Intestinal Anastomosis Clamps



M.F.ELAHI MEDICAL CO
SERVING WORLDWIDE SURGICAL INSTRUMENTS



18-3644-18-3646
Kocher

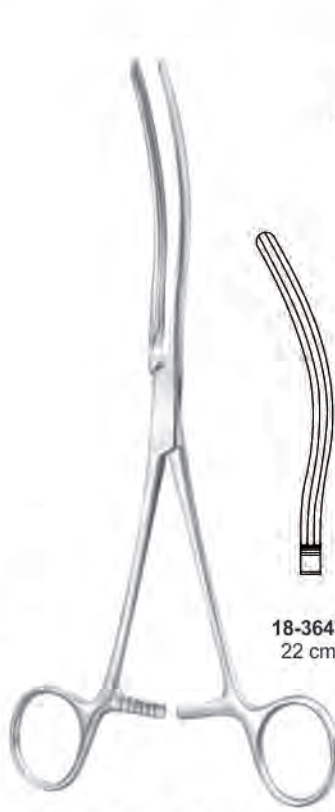
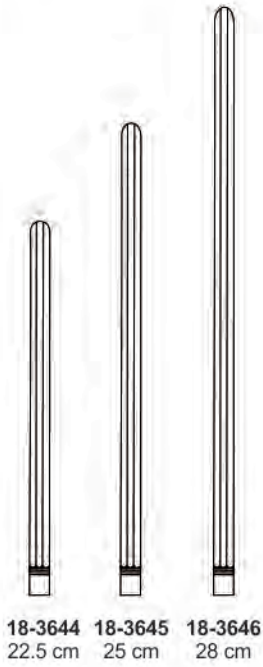

18-3647-18-3649
Kocher

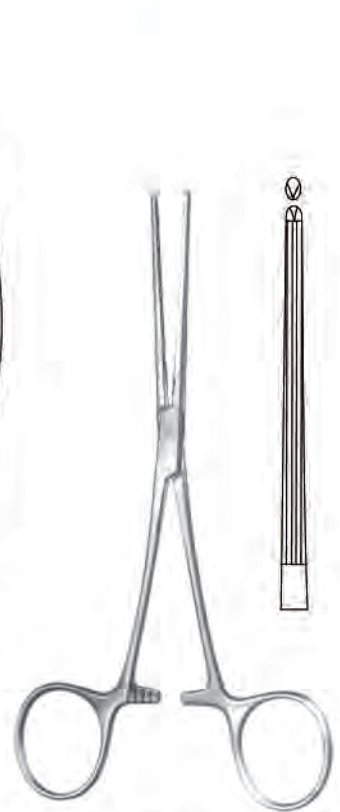
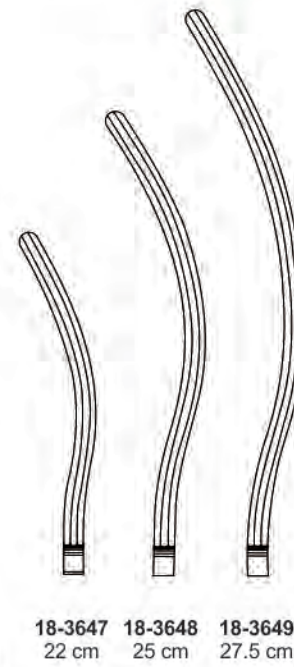

18-3650
Allen
16 cm

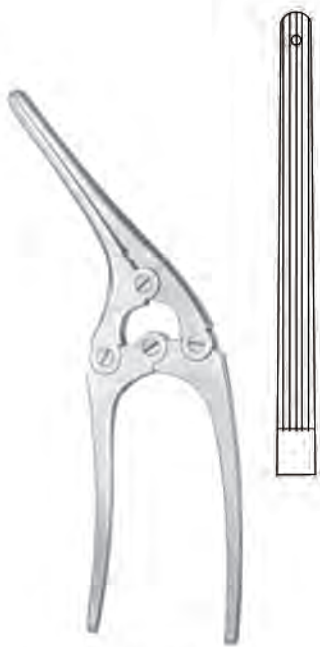

18-3651
Payr-Baby
15 cm



18-3652-18-3654
Payr

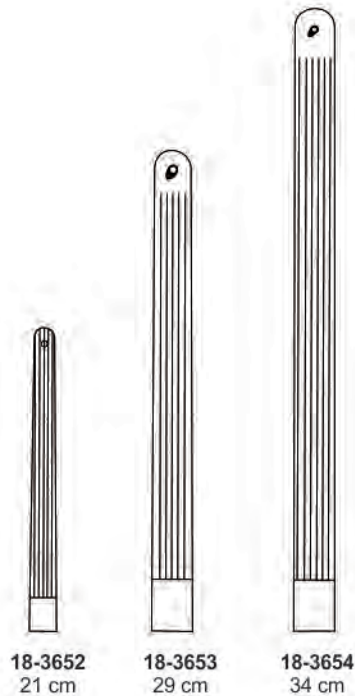

18-3655
Benson
15.5 cm





Intestinal Anastomosis Clamps

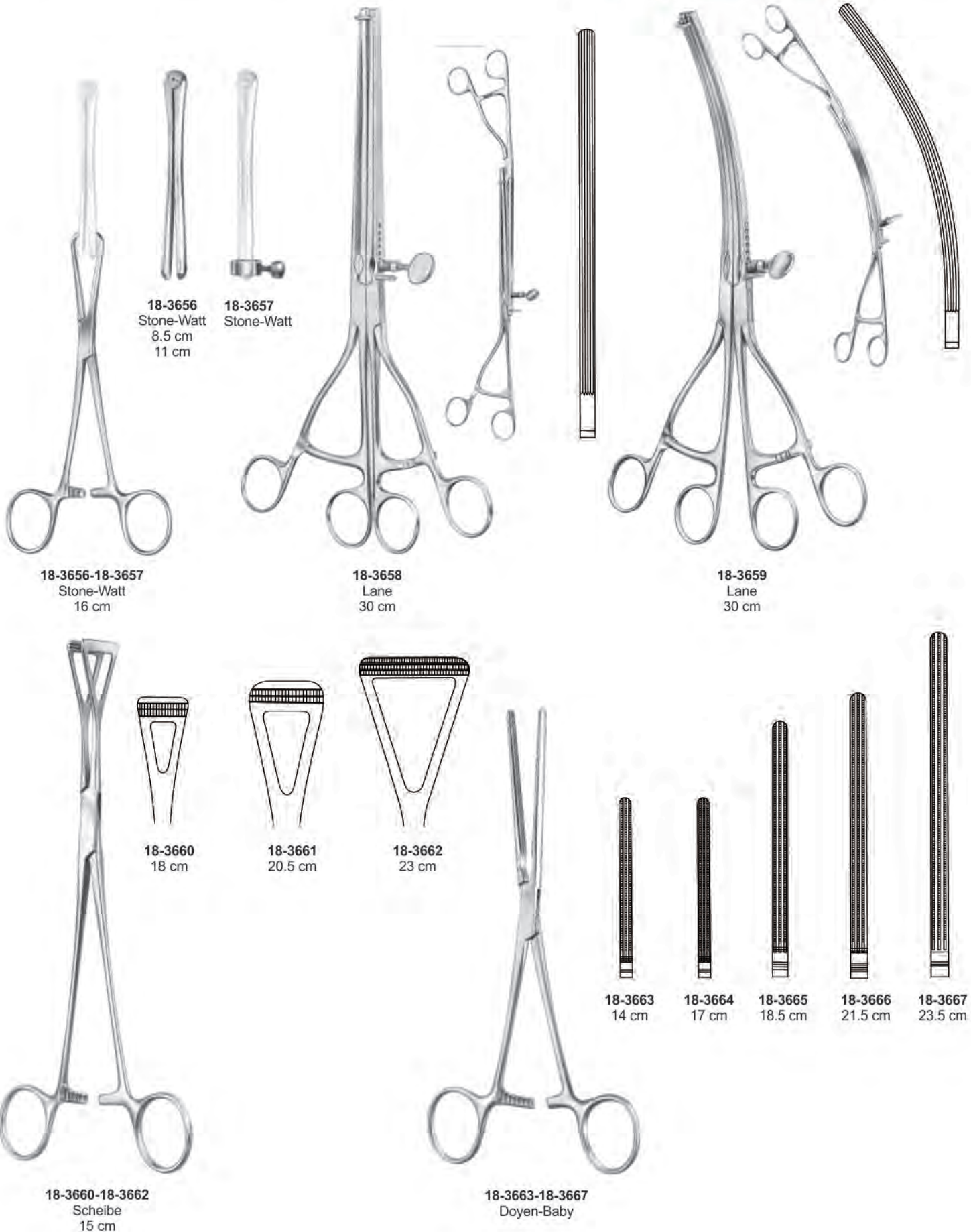



Intestinal Clamps

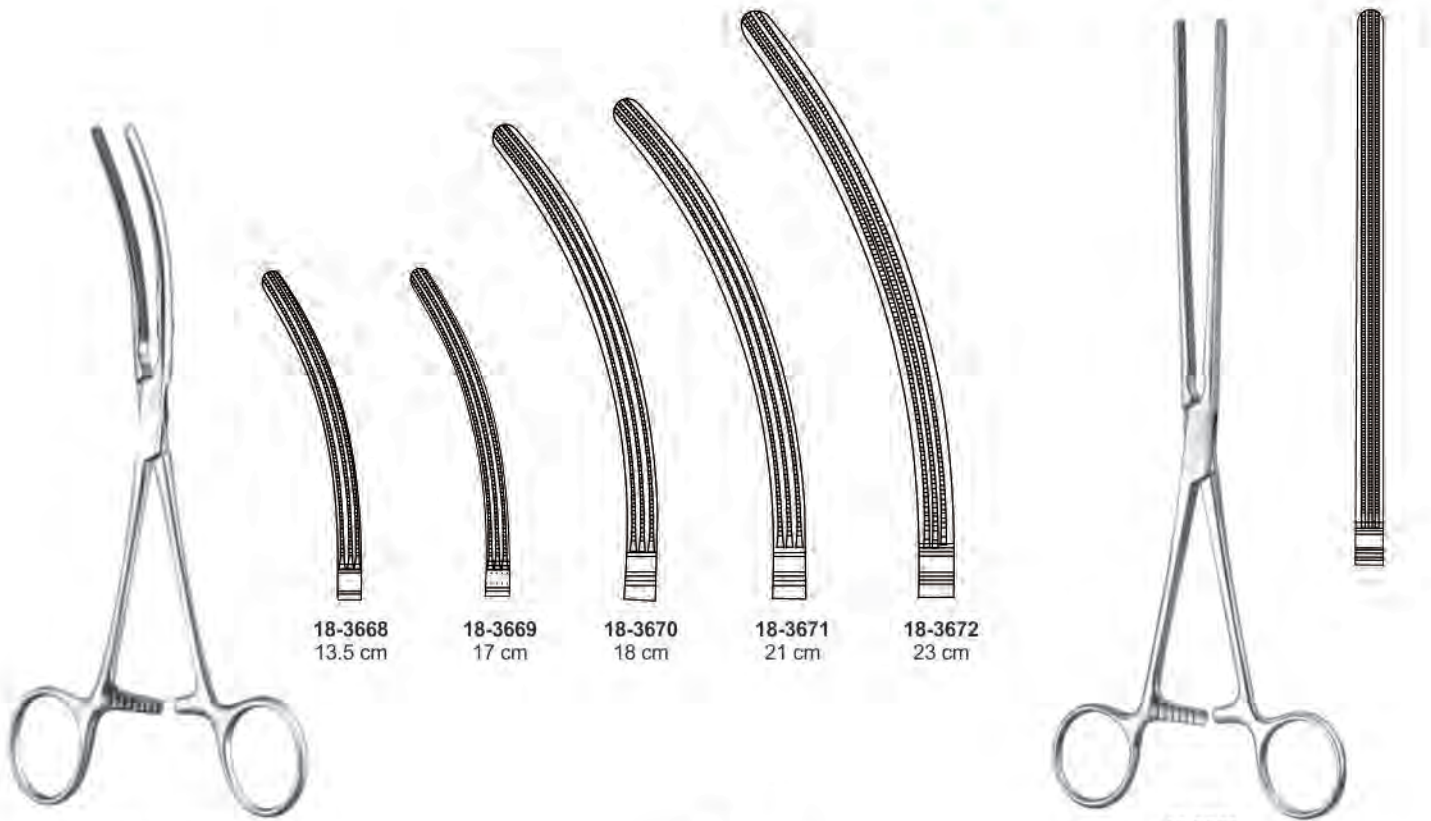

18-3668
13.5 cm

18-3669
17 cm

18-3670
18 cm

18-3671
21 cm

18-3672
23 cm

18-3668-18-3672
Doyen-Baby

18-3673
Mayo-Robson
26 cm

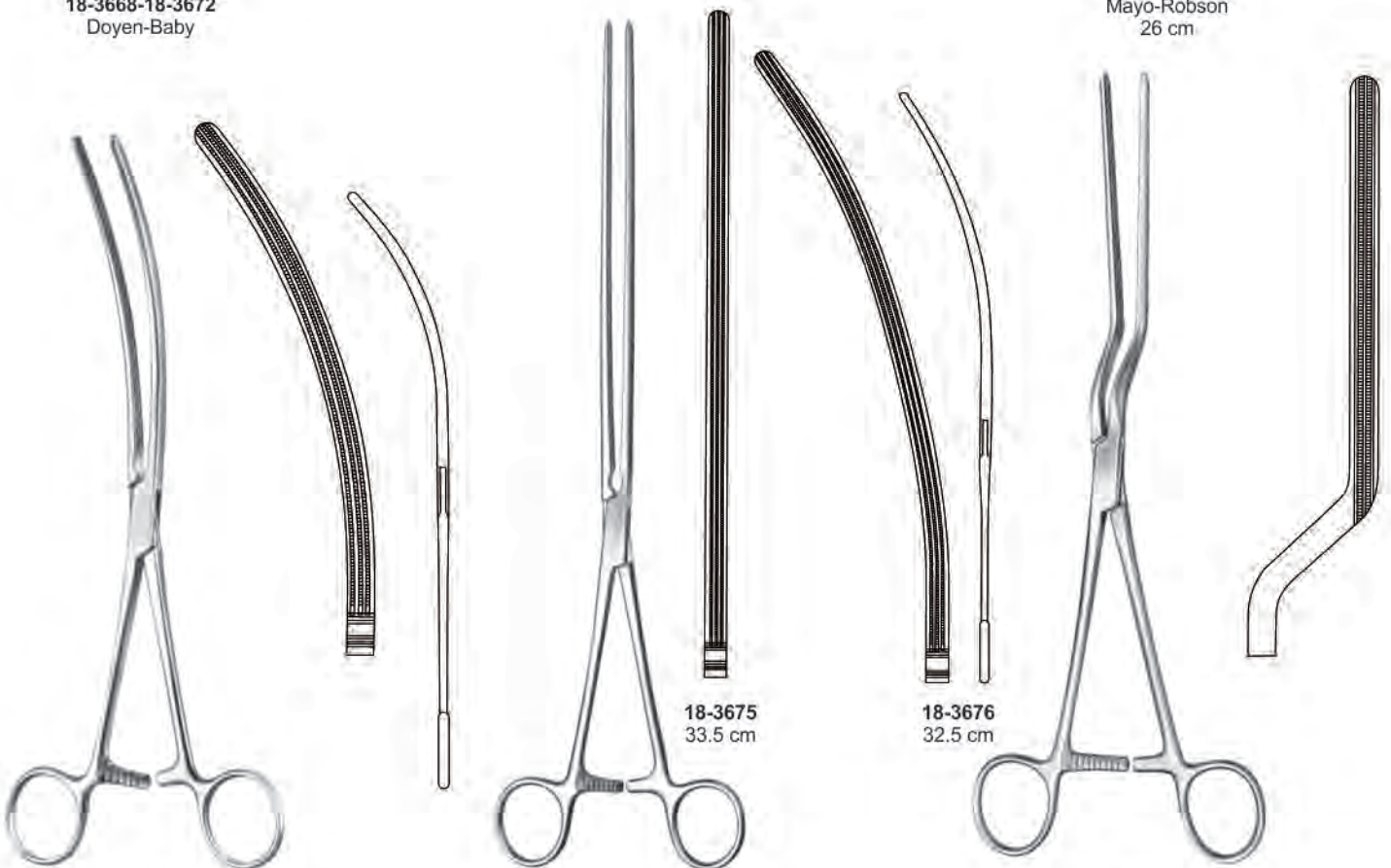

18-3675
33.5 cm

18-3676
32.5 cm

18-3674
Mayo-Robson
25 cm

18-3675-18-3676
Scudder

18-3677
Brunner
27 cm



Sigmoid Anastomosis Forceps



M.F.ELAHI MEDICAL CO
SERVING WORLDWIDE SURGICAL INSTRUMENTS



18-3678-18-3679
Hayes

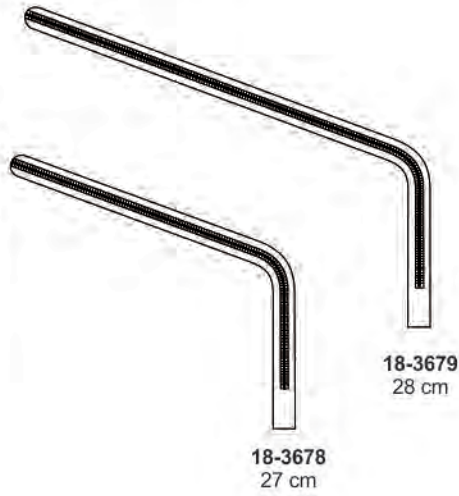

18-3678
27 cm

18-3679
28 cm

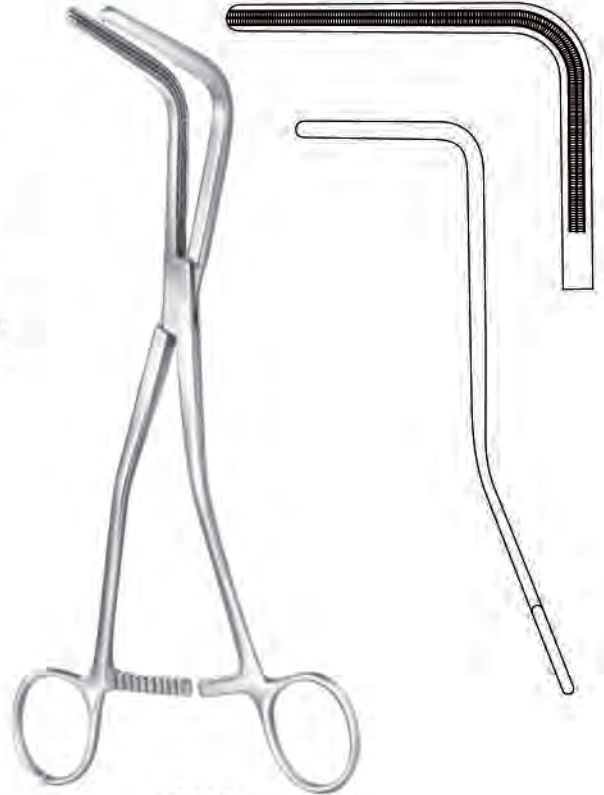

18-3680
Veidenheimer
25 cm



18-3681
Fehland
24 cm



18-3682
Resano
28 cm

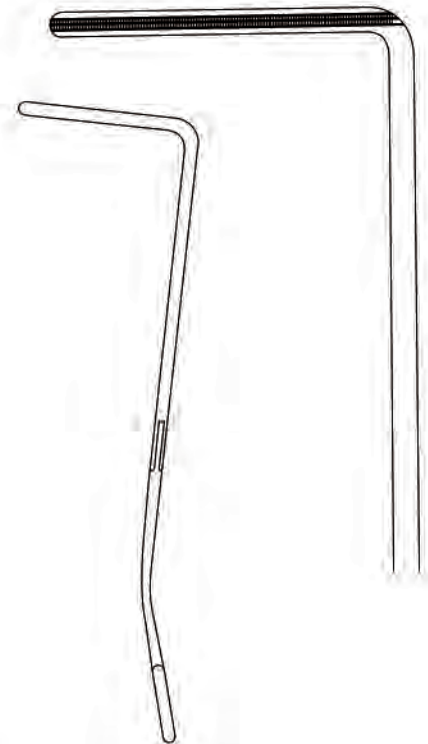

Rectal Specula, Sphincteroscopes,
Hemorrhoidal Ligator



M.F.ELAHI MEDICAL CO
SERVING WORLDWIDE SURGICAL INSTRUMENTS



18-3683
Czerny
22.5 cm



70 x 15 mm

18-3684
Sims
15.5 cm



70 x 15 mm

18-3685
Sims
15.5 cm



Ø 22 mm

18-3686
Ives-Fansler
80 mm



18-3687
Alan-Parks
14 cm



18-3688
Kelly





Rectal Biopsy Forceps



18-3689
Rudd
27.5 cm

400 mm

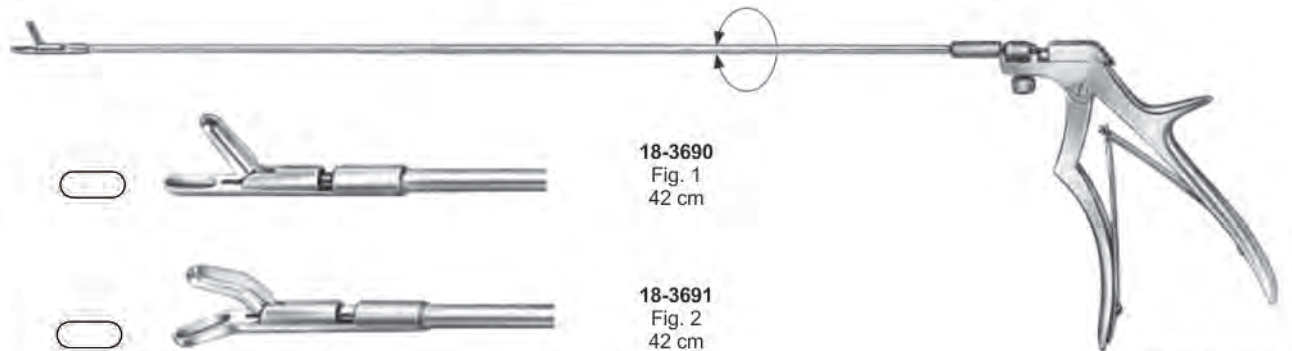

18-3690
Fig. 1
42 cm

18-3691
Fig. 2
42 cm

18-3692
Fig. 3
42 cm

18-3693
Fig. 4
42 cm

18-3694
Fig. 5
42 cm

18-3690-18-3694

380 mm

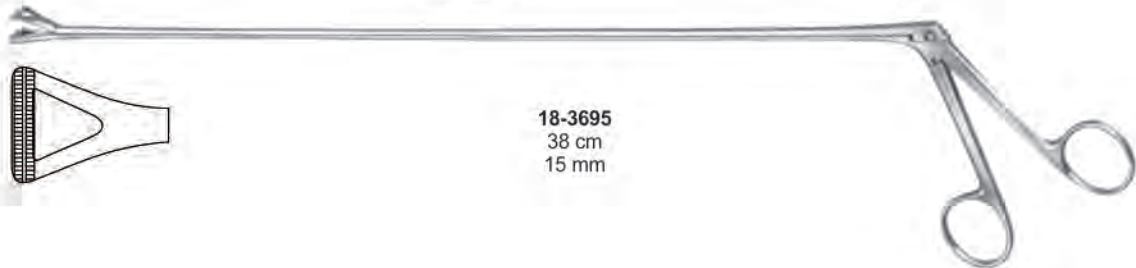

18-3695
38 cm
15 mm



Kidney Pedicle Clamp Forceps, Nephrostomy Forceps



19-3700-19-3704
Guyon

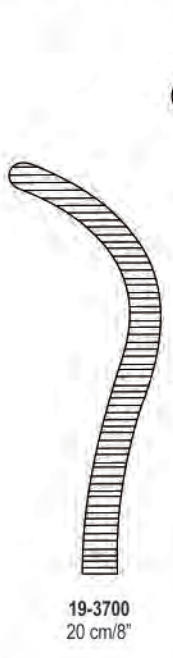

19-3700
20 cm/8"

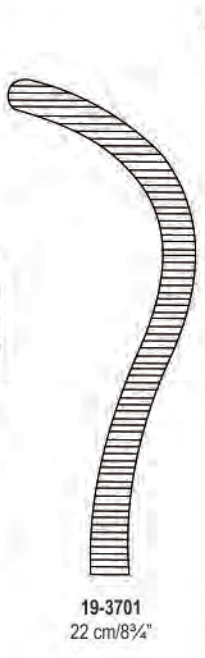

19-3701
22 cm/8¾"

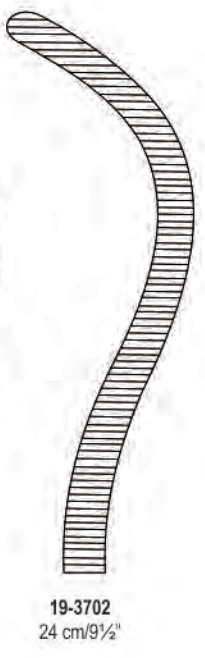

19-3702
24 cm/9½"



19-3703
23 cm/9"



19-3704
24 cm/9½"

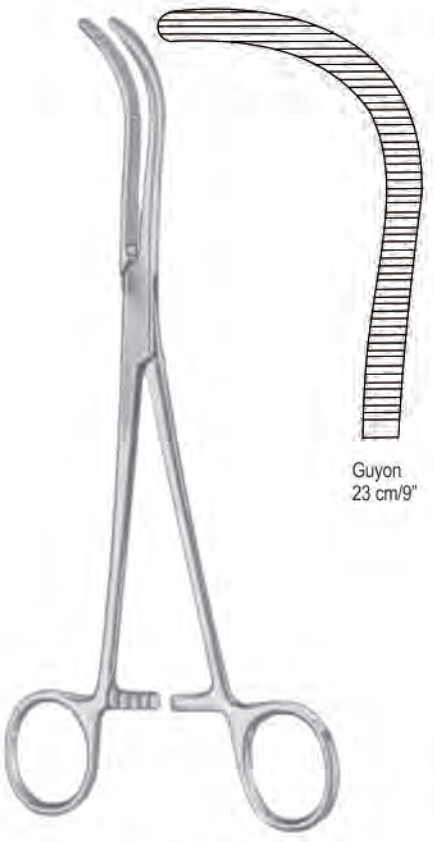

19-3705
Guyon

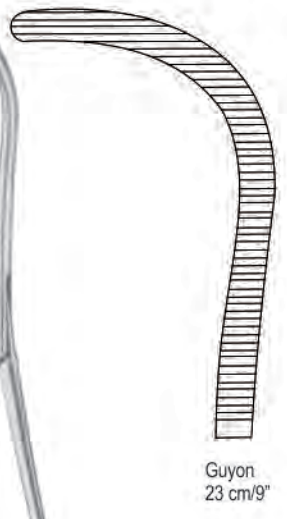

Guyon
23 cm/9"



19-3706
Elsasser
20 cm/8"



20 cm/8"

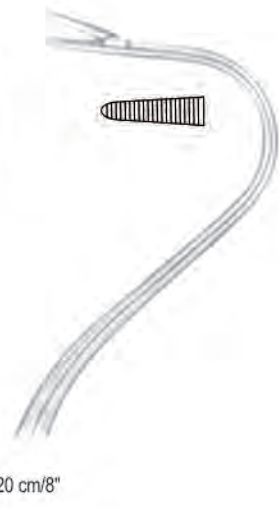

19-3707
Randall





Kidney Stones, Gall Duct Forceps



19-3708
Randall

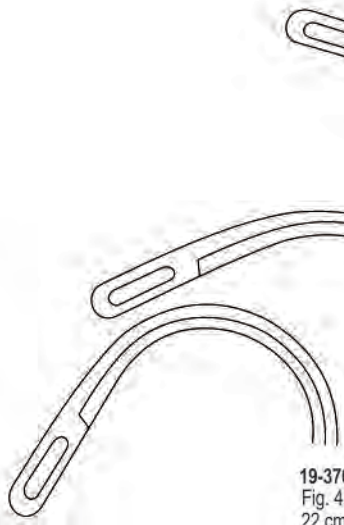

19-3708
Fig. 4
22 cm/8 3/4"

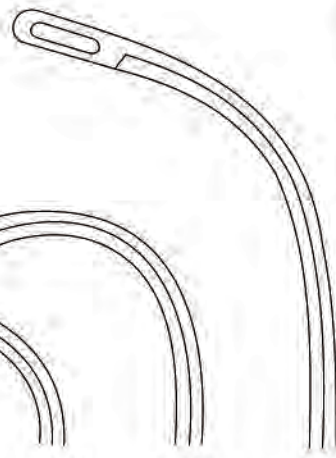

19-3709
Fig. 3
22 cm/8 3/4"



19-3710
Fig. 2
22 cm/8 3/4"



19-3711
Fig. 1
23 cm/8"



19-3712-19-3713
Gray

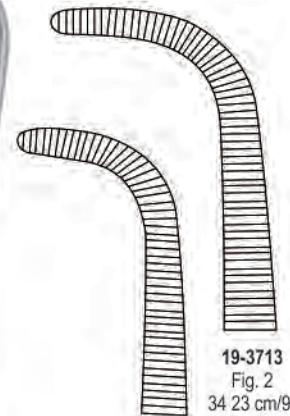

19-3713
Fig. 2
34 23 cm/9"

19-3712
Fig. 1
22 cm/8 3/4"

Set of 2 Pieces



19-3714-19-3715
Gray

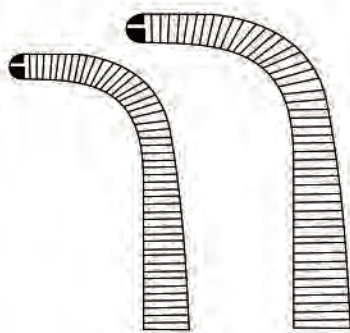

19-3714
Fig. 1
22 cm/8 3/4"

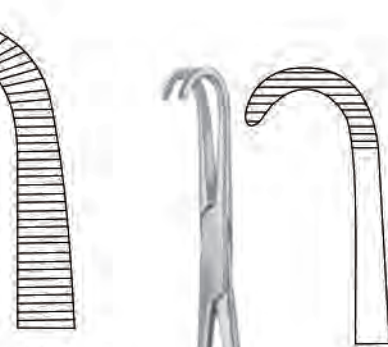

19-3715
Fig. 2
34 23 cm/9"

Set of 2 Pieces



19-3716
Desjardins
21 cm/8 1/4"

Gall duct and
cystic forceps



19-3717
Nissen
21.5 cm/8 1/2"



Gall Stone Forceps, Gall Duct Dilators



M.F.ELAHI MEDICAL CO
SERVING WORLDWIDE SURGICAL INSTRUMENTS



19-3718-19-3719
Blake
21 cm / 8 2/8"

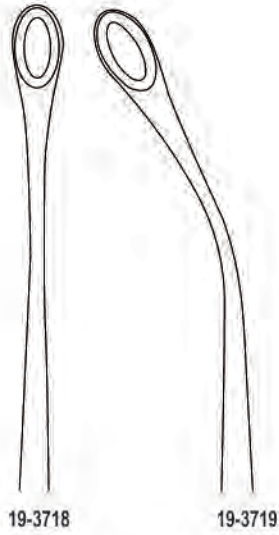

19-3720
Mayo-Blake
21 cm / 8 2/8"



19-3721
Mayo-Blake
21 cm / 8 2/8"



19-3722
Czerny
24.5 cm / 9"



19-3723-19-3724
Desjardins
23 cm / 9"

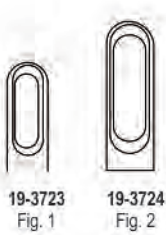

19-3725-19-3734
Bakes
32 cm / 12 5/8"

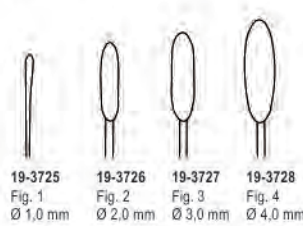

19-3725 Fig. 1 Ø 1,0 mm
19-3726 Fig. 2 Ø 2,0 mm
19-3727 Fig. 3 Ø 3,0 mm
19-3728 Fig. 4 Ø 4,0 mm

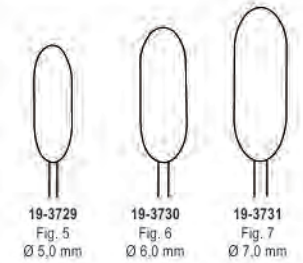

19-3729 Fig. 5 Ø 5,0 mm
19-3730 Fig. 6 Ø 6,0 mm
19-3731 Fig. 7 Ø 7,0 mm

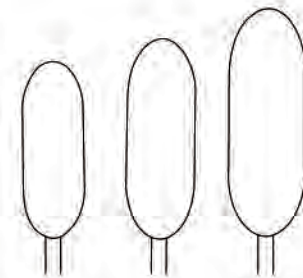

19-3732 Fig. 8 Ø 8,0 mm
19-3733 Fig. 9 Ø 9,0 mm
19-3734 Fig. 10 Ø 10,0 mm



19-3735-19-3742
Luer-Körte
32 cm / 12 5/8"

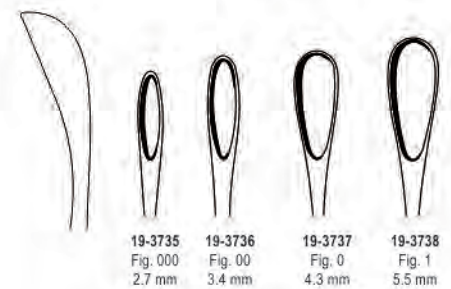

19-3735 Fig. 000 2,7 mm
19-3736 Fig. 00 3,4 mm
19-3737 Fig. 0 4,3 mm
19-3738 Fig. 1 5,5 mm

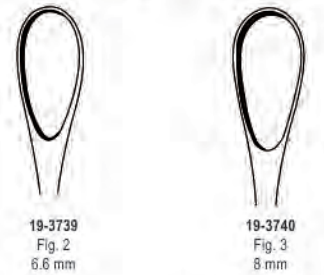

19-3739 Fig. 2 6,6 mm
19-3740 Fig. 3 8 mm

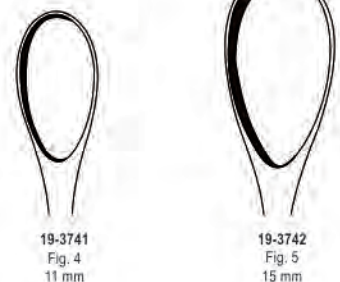

19-3741 Fig. 4 11 mm
19-3742 Fig. 5 15 mm

Gall Stone Scoops, Prostatic Retractors



M.F. ELAHI MEDICAL CO
SERVING WORLDWIDE SURGICAL INSTRUMENTS



19-3743
Mayo
28 cm / 11"



19-3744-19-3746
Mayo
26.5 cm / 10 1/2"



19-3744
Fig. 1



19-3745
Fig. 2



19-3746
Fig. 3



19-3747
Moore
28 cm / 11"



19-3748-19-3750
Fergusson
24 cm / 9 1/2"



19-3748
Fig. 1



19-3749
Fig. 2



19-3750
Fig. 3



19-3751
Young
22 cm / 8 5/8"



19-3752
Young
21.5 cm / 8 4/8"



19-3753
Young
23 cm / 9"



19-3754
Young
22 cm / 8 3/4"



Capsule Forceps, Ligature Carrying Forceps,
Bladder Neck Spreader



M.F. ELAHI MEDICAL CO
SERVING WORLDWIDE SURGICAL INSTRUMENTS



19-3755
Millin
24,5 cm / 9 5/8"



19-3756
Millin
22,5 cm / 8 7/8"



19-3757
Millin
24,5 cm / 9 5/8"



19-3758
Millin
22 cm / 8 5/8"



19-3759
Millin
24 cm / 9 4/8"



19-3760
Millin
29,5 cm / 11 5/8"



Bladder Neck Spreader, Bladder Retractors



M.F.ELAHI MEDICAL CO
SERVING WORLDWIDE SURGICAL INSTRUMENTS



19-3761
Legueu

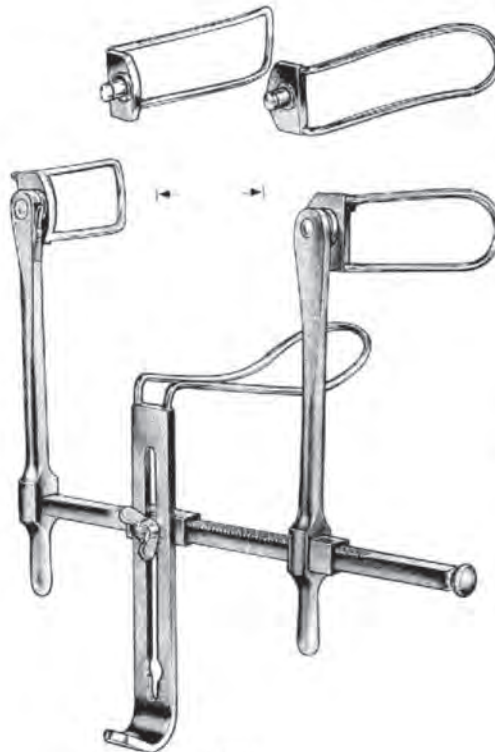

19-3762
Gosset

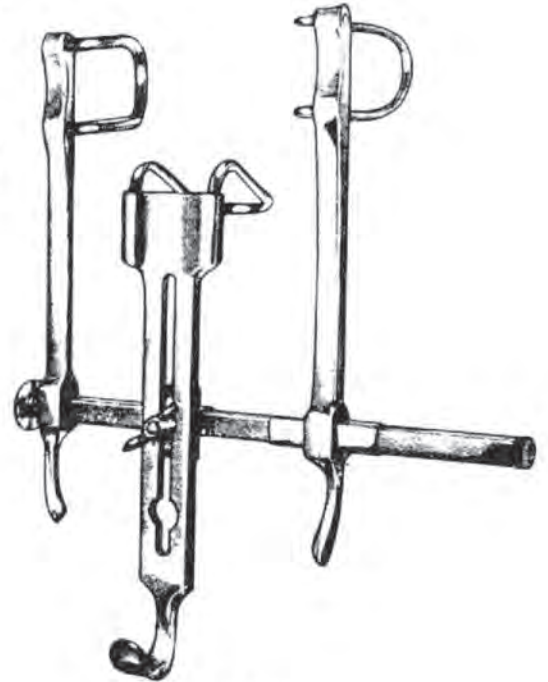

19-3763
Pantings



19-3764
Judd-Masson



19-3765-19-3768
Millin



19-3765

19-3766



19-3767

19-3768



Bladder Retractors



M.F. ELAHI MEDICAL CO
SERVING WORLDWIDE SURGICAL INSTRUMENTS



19-3769
Thomson-Walker



19-3770
Legueu
27 cm/10 1/2"



19-3771
Kocher
26 cm/10 1/4"



19-3772
Kocher
26 cm/10 1/4"

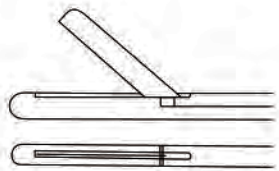

19-3773
Sachse



19-3774
Mathieu

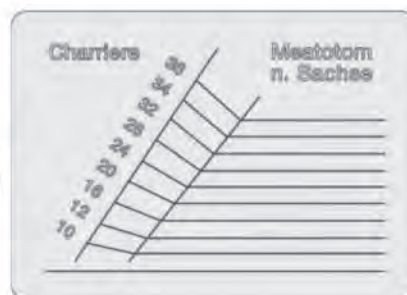

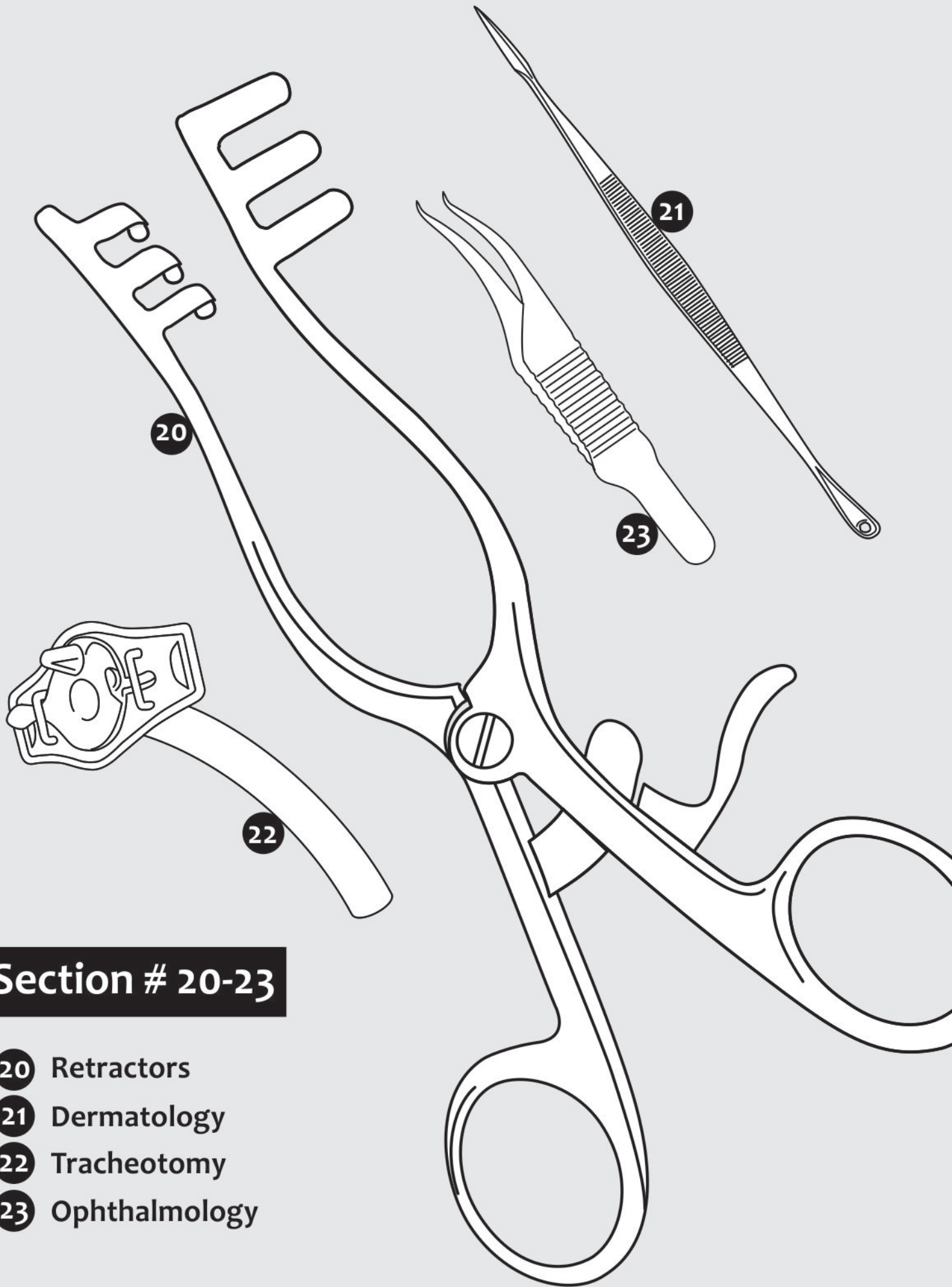

Section # 20-23

- 20 Retractors
- 21 Dermatology
- 22 Tracheotomy
- 23 Ophthalmology

Intestinal and Tissue Grasping Forceps



M.F.ELAHI MEDICAL CO
SERVING WORLDWIDE SURGICAL INSTRUMENTS

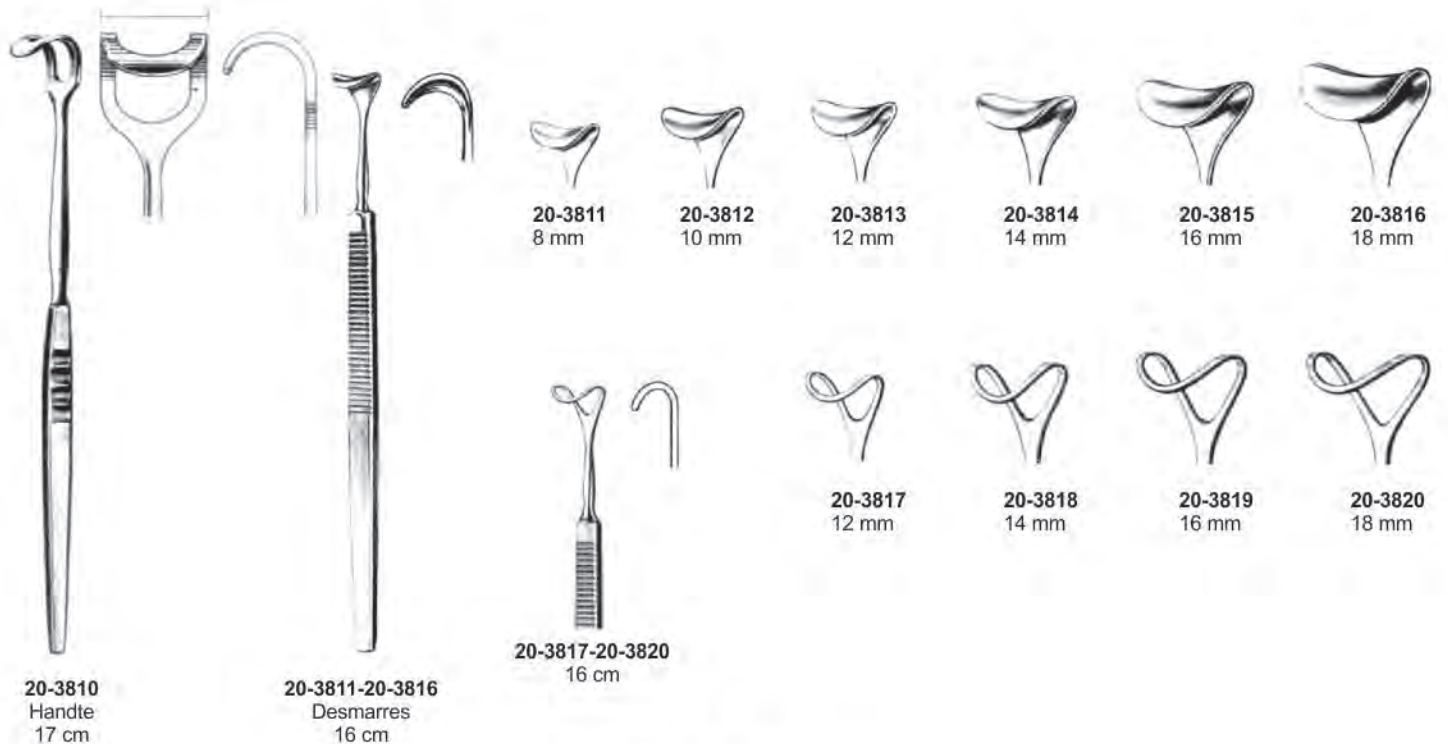
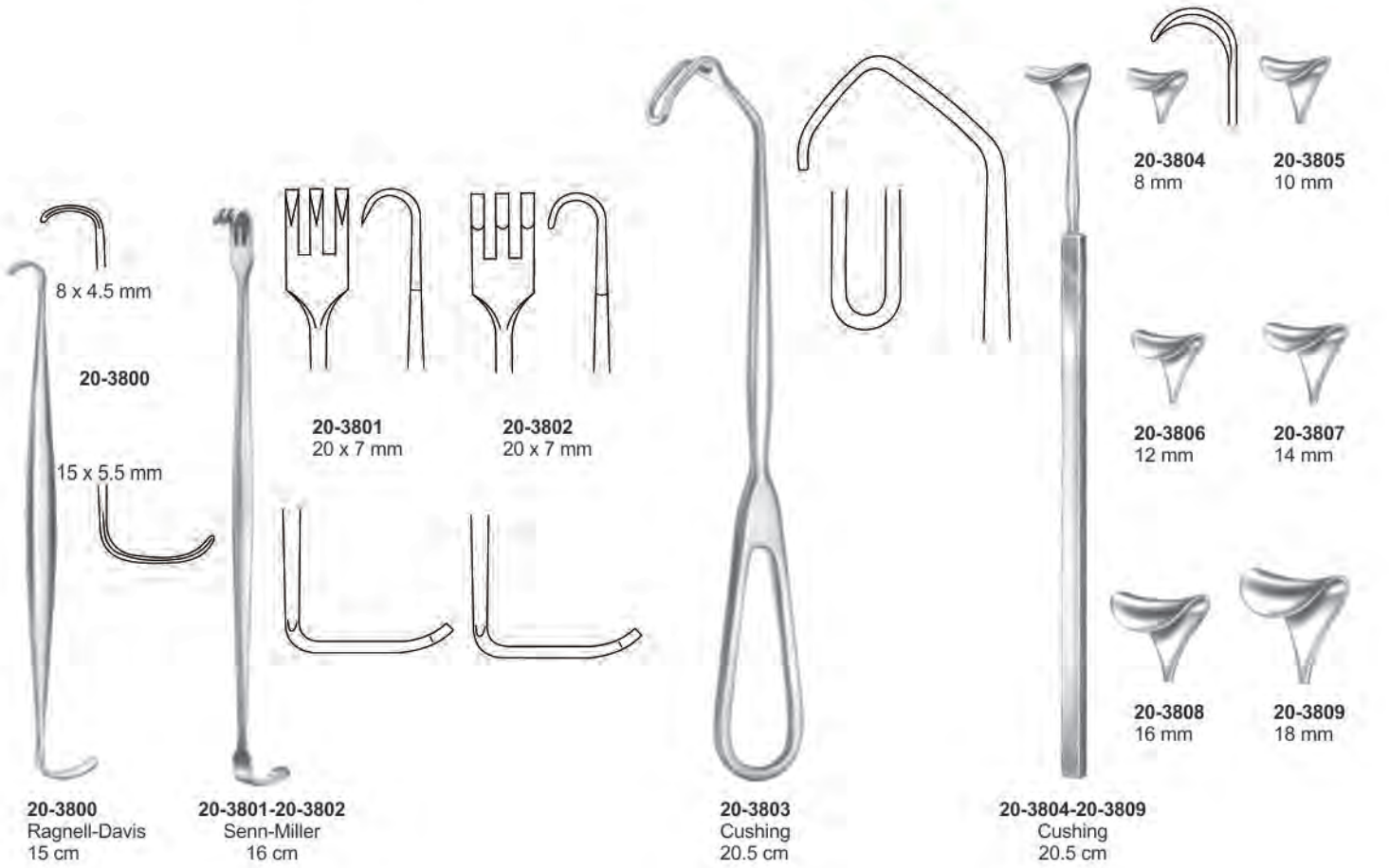



Saddle Hooks, Hooklets, Retractors

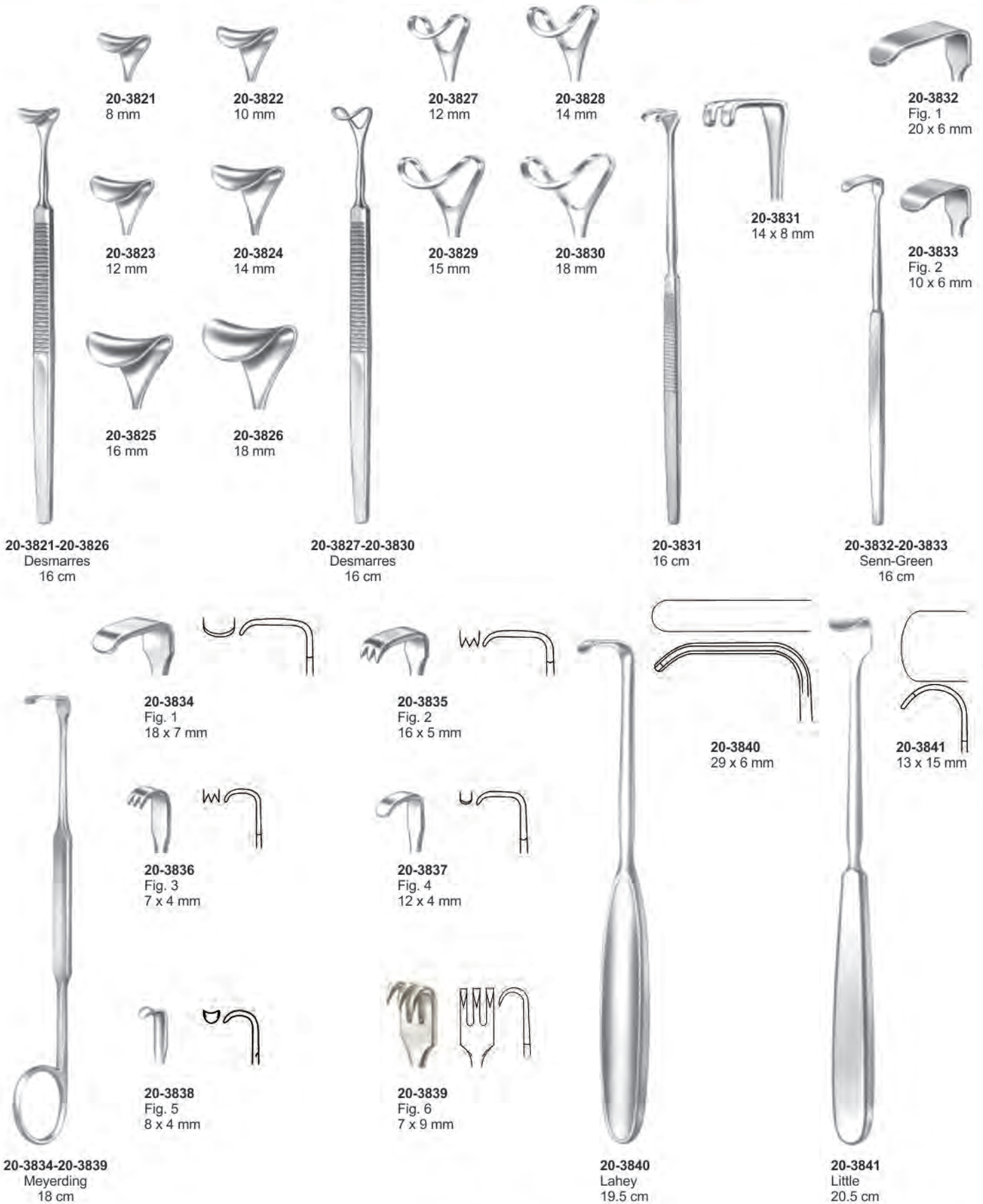

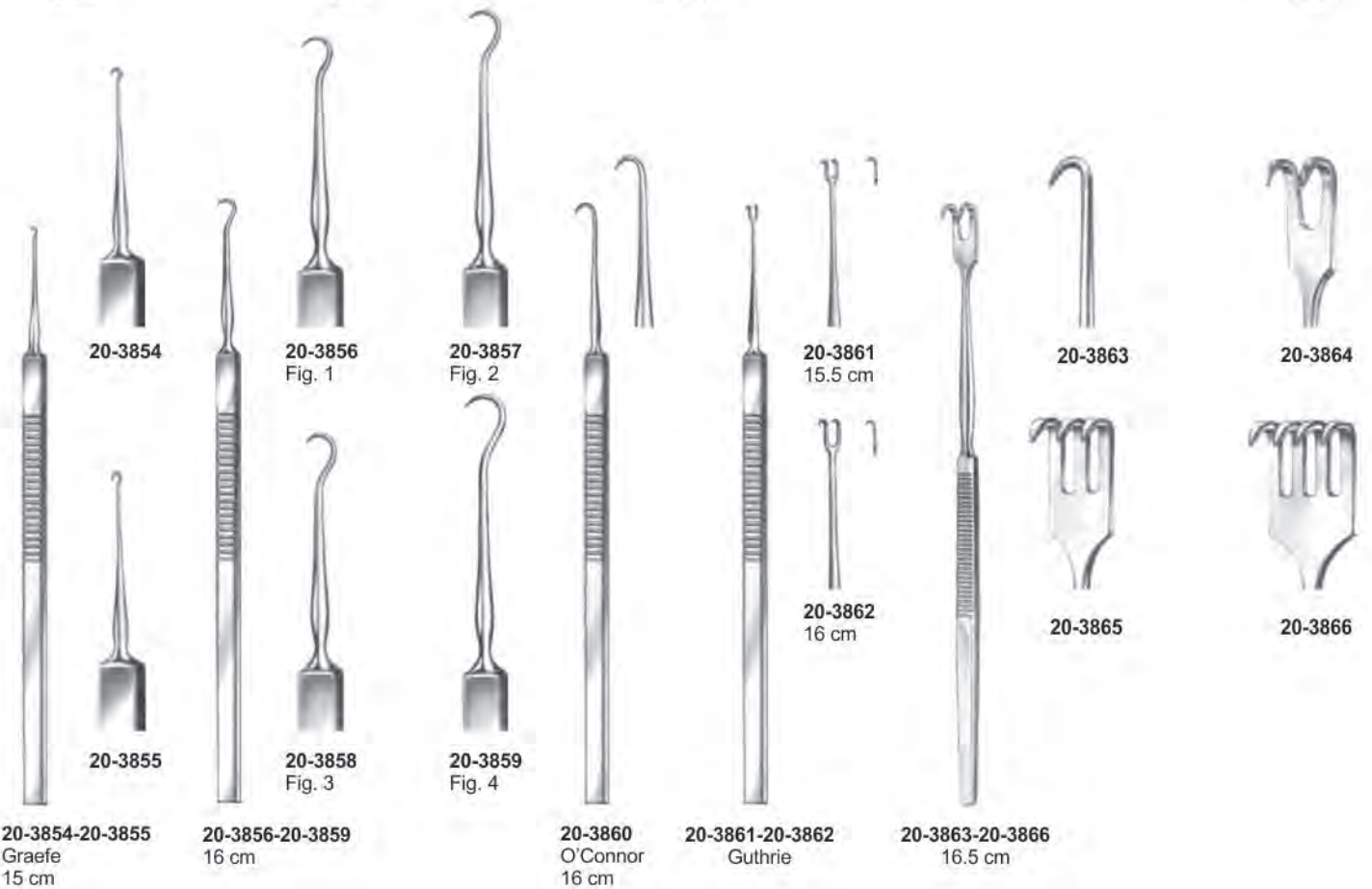
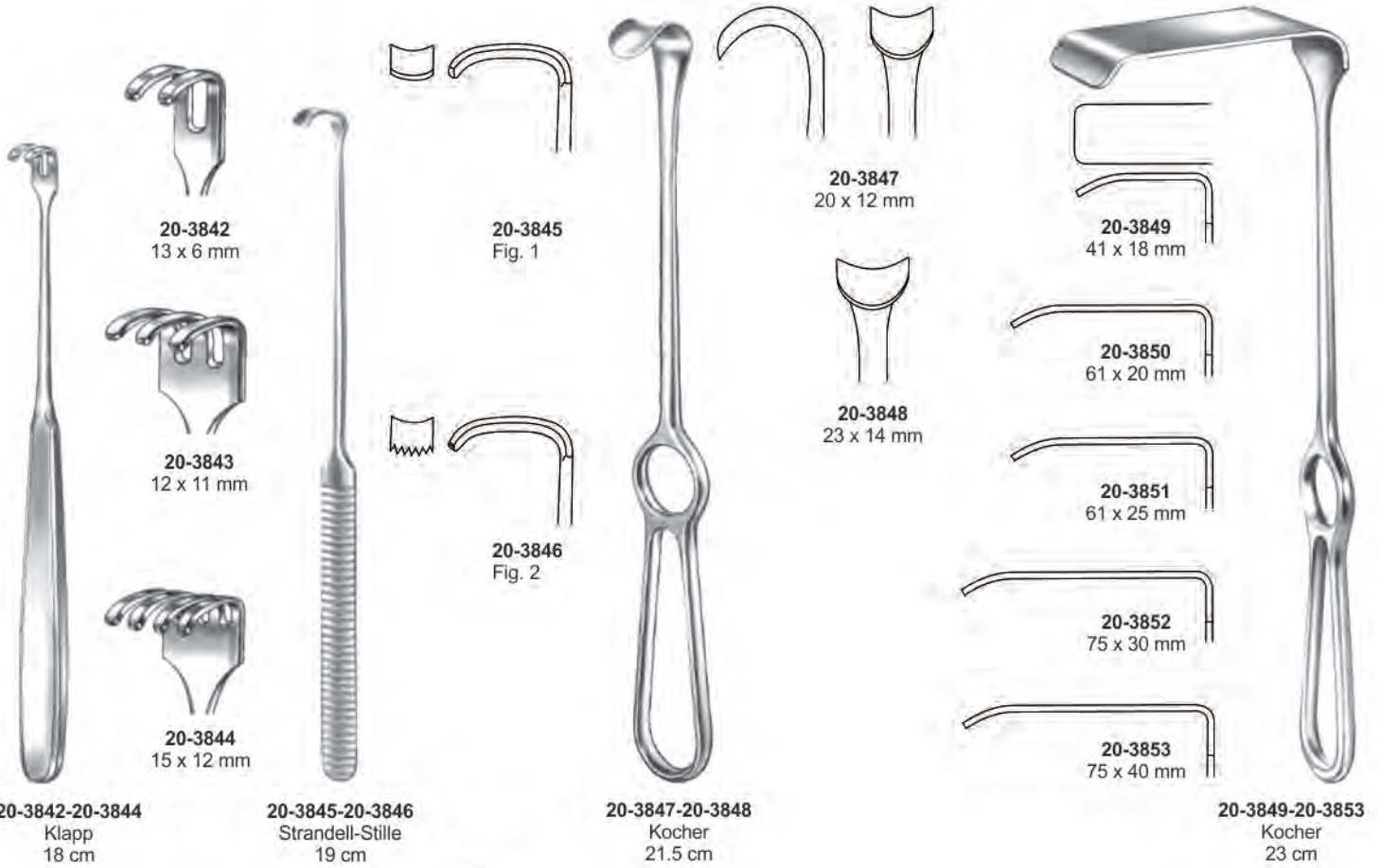



Hooklets, Retractors

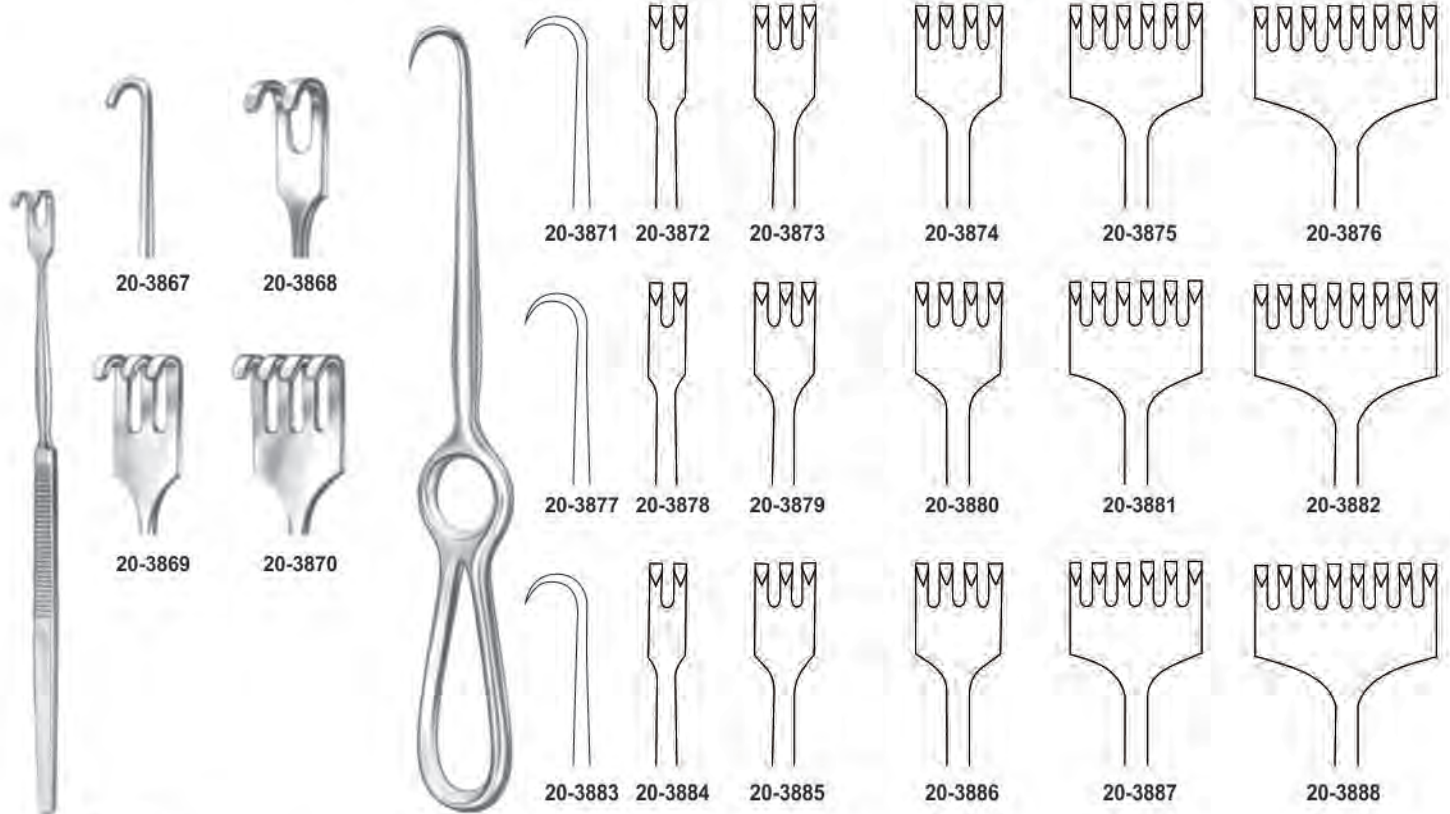

20-3867-20-3870
16.5 cm

20-3871-20-3888
Kocher
22 cm



20-3889
Ollier
24.5 cm
37 x 30 mm

20-3890
Ollier
23 cm
39 x 60 mm

20-3891-20-3905
Volkmann
22 cm

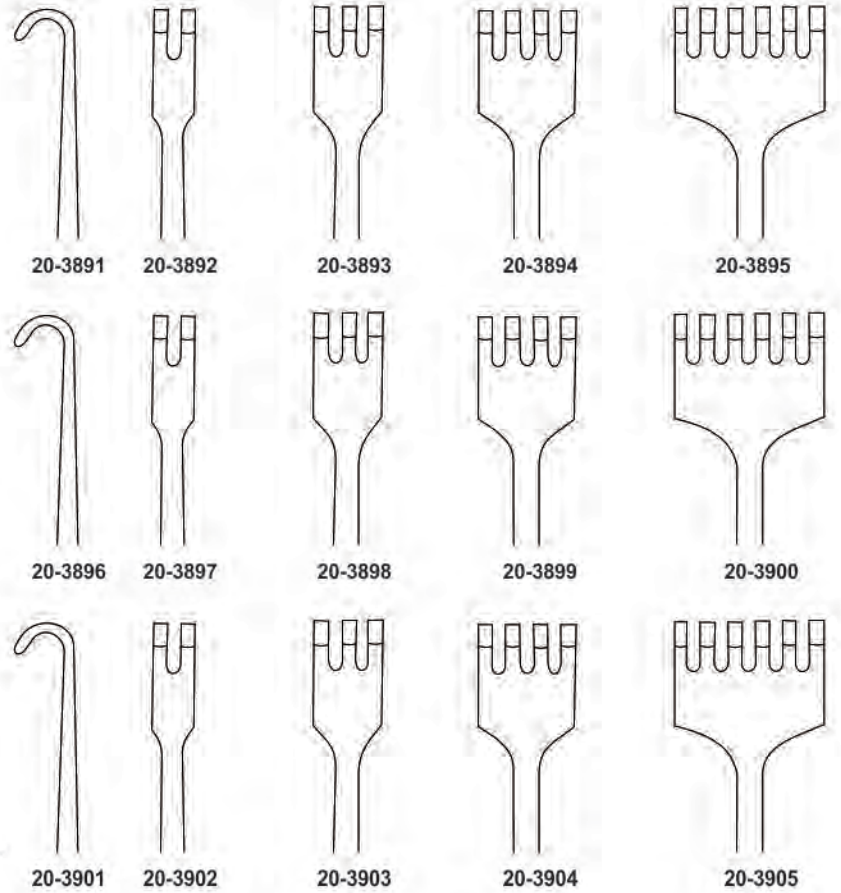

20-3891

20-3892

20-3893

20-3894

20-3895

20-3896

20-3897

20-3898

20-3899

20-3900

20-3901

20-3902

20-3903

20-3904

20-3905





Hooklets, Retractors

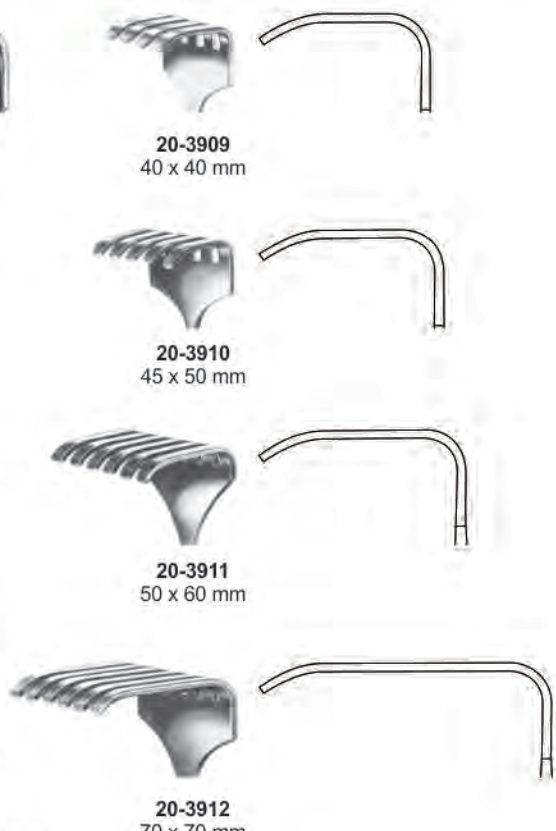

20-3906
Wassmund
20.5 cm
33 x 20 mm

20-3907
Körte
24.5 cm
25 x 40 mm

20-3908
Körte
24.5 cm
25 x 30 mm

20-3909-20-3912
Israel
24.5 cm

20-3909
40 x 40 mm

20-3910
45 x 50 mm

20-3911
50 x 60 mm

20-3912
70 x 70 mm



20-3913
Fig. 1
26 cm
25 x 20 mm
30 x 28 mm



20-3915
23.5 cm
25 x 21 mm

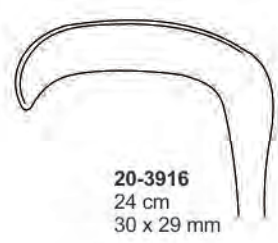

20-3916
24 cm
30 x 29 mm

48 x 22 mm



62 x 50 mm

20-3914
Fig. 2
27.5 cm
43 x 38 mm
63 x 44 mm

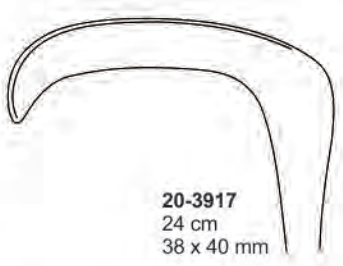

20-3917
24 cm
38 x 40 mm

20-3913-20-3914
Richardson-Eastman

20-3915-20-3917
Richardson

20-3918
Richardson
24 cm

20-3919
Kelly
26 cm





Retractors



20-3920-20-3922
Fritsch



20-3920
23.5 cm
37 x 31 mm



20-3923
24 cm
38 x 40 mm



20-3921
25 cm
43 x 51 mm



20-3924
25 cm
49 x 61 mm



20-3922
25.5 cm
48 x 75 mm

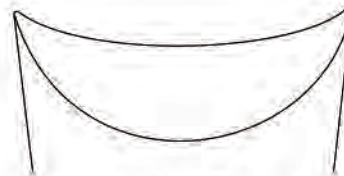

20-3925
29.5 cm
65 x 85 mm

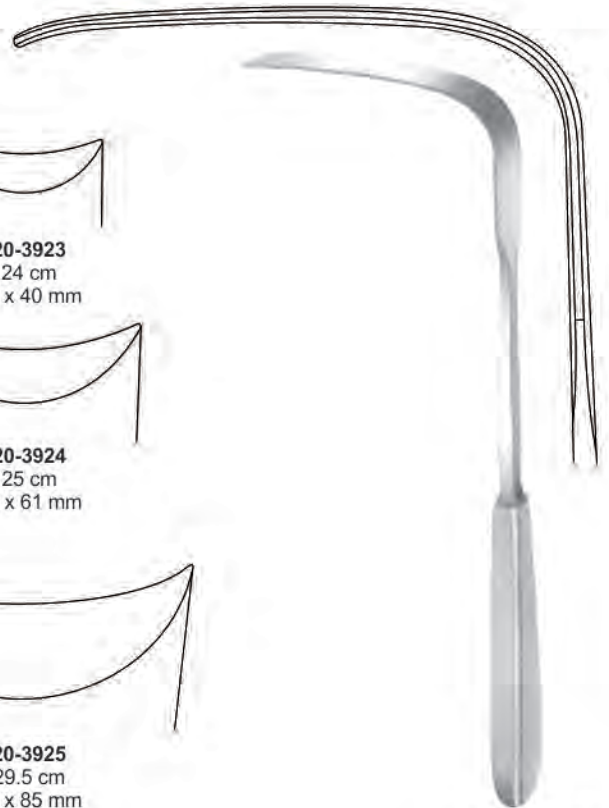

20-3923-20-3925
Tubinger Modell
28 cm



20-3926
Martin
26.5 cm

20-3926
110 x 27 mm



20-3927-20-3928
Simon
28 cm

20-3927
115 x 22 mm

20-3928
115 x 28 mm



20-3929
Simon
28 cm



Retractors



M.F.ELAHI MEDICAL CO
SERVING WORLDWIDE SURGICAL INSTRUMENTS



20-3930
Davidson
19 cm
80 x 54 mm



20-3931
Davidson
18.5 cm
75 x 93 mm



20-3932
Sauerbruch
25.5 cm



20-3933-20-3938
Brunner
25.5 cm

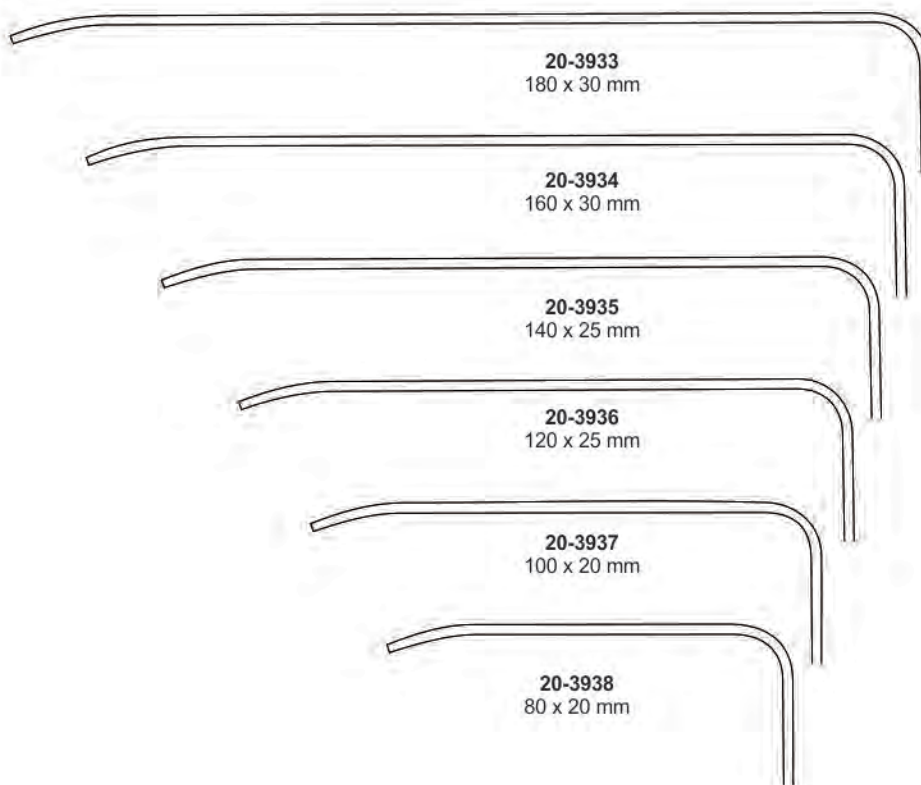

20-3933
180 x 30 mm

20-3934
160 x 30 mm

20-3935
140 x 25 mm

20-3936
120 x 25 mm

20-3937
100 x 20 mm

20-3938
80 x 20 mm



20-3939
Deaver
18 cm
19 mm

20-3940
Deaver
21.5 cm
22 mm

20-3941
Deaver
21.5 cm
25 mm

20-3942
Deaver
30.5 cm
25 mm

20-3943
Deaver
33.5 cm
25 mm

20-3944
Deaver
34.5 cm
25 mm



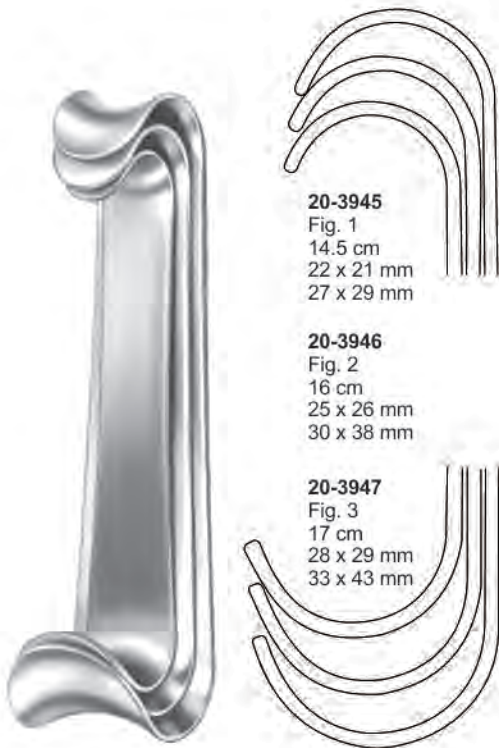

20-3945
Fig. 1
14.5 cm
22 x 21 mm
27 x 29 mm

20-3946
Fig. 2
16 cm
25 x 26 mm
30 x 38 mm

20-3947
Fig. 3
17 cm
28 x 29 mm
33 x 43 mm

20-3945-20-3947
Roux



20-3948
Fig. 1
26 x 10 mm / 30 x 13 mm

20-3949
Fig. 2
30 x 10 mm / 34 x 13 mm

20-3948-20-3949
Farabeuf
12 cm

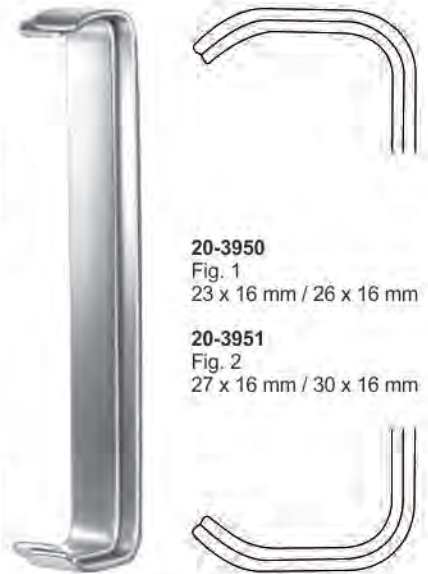

20-3950
Fig. 1
23 x 16 mm / 26 x 16 mm

20-3951
Fig. 2
27 x 16 mm / 30 x 16 mm

20-3950-20-3951
Farabeuf
15.5 cm



6 x 7 mm
7 x 8 mm

17 x 17 mm
24 x 21 mm

20-3952
Roux-Mini
14.5 cm

20-3953
Roux-Baby
12.5 cm

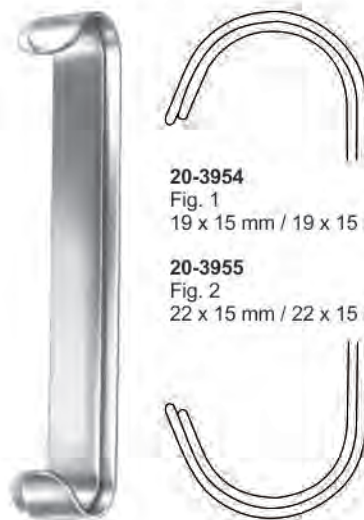

20-3954
Fig. 1
19 x 15 mm / 19 x 15 mm

20-3955
Fig. 2
22 x 15 mm / 22 x 15 mm

20-3954-20-3955
Parker
14 cm

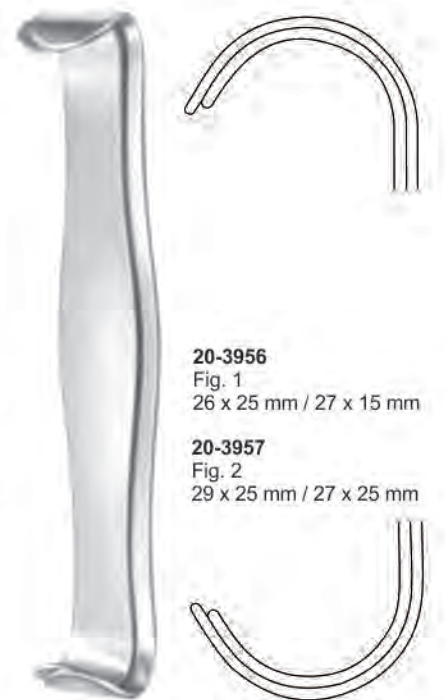

20-3956
Fig. 1
26 x 25 mm / 27 x 15 mm

20-3957
Fig. 2
29 x 25 mm / 27 x 25 mm

20-3956-20-3957
Parker
18.5 cm



Retractors



20-3958-20-3959
Parker-Mott



20-3958
Fig. 1
21 x 24 mm
Fig. 2
25 x 24 mm



20-3959
Fig. 1
68 x 24 mm
Fig. 2
72 x 24 mm



20-3960-20-3961
Mathieu
20 cm

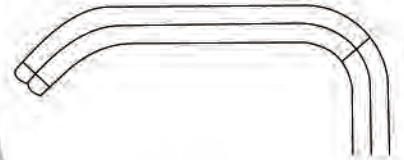

20-3960
Fig. 1
42 x 13 mm / 42 x 26 mm

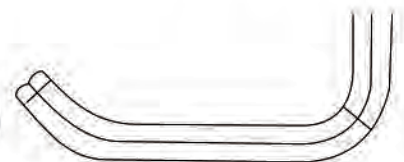

20-3961
Fig. 2
47 x 13 mm / 46 x 26 mm



20-3962-20-3963
Parker-Langenbeck
21.5 cm

20-3962
Fig. 1
21 x 15 mm / 40 x 15 mm

20-3963
Fig. 2
25 x 15 mm / 45 x 15 mm



26 x 30 mm



20-3964
Goelet

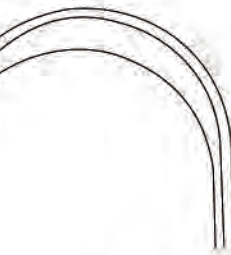

35 x 40 mm

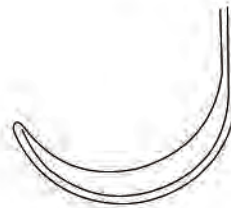

20-3965
Crile
11 cm

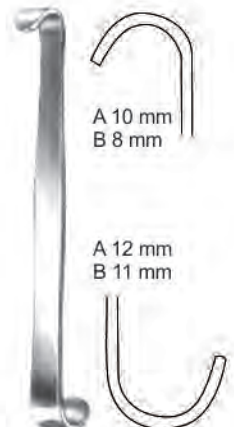

20-3966
Luer
11 cm

A 10 mm
B 8 mm

A 12 mm
B 11 mm



Wound Spreaders, self-retaining



M.F.ELAHI MEDICAL CO
SERVING WORLDWIDE SURGICAL INSTRUMENTS



20-3967-20-3970
Finsen



20-3967
5 cm



20-3968
5 cm

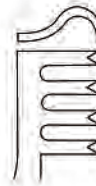

20-3969
7 cm



20-3970
7 cm



20-3971-20-3972
Finsen-Martin
7.5 cm



20-3971
30 mm

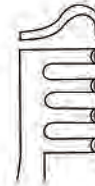

20-3972
30 mm



20-3973
Logan
3.5 cm

20-3974
16 mm



20-3975
Buckley



20-3976-20-3979
Alm



20-3976
7 cm



20-3977
10 cm



20-3978
7 cm



20-3979
10 cm



20-3980
10 cm



20-3981
24 mm



20-3982
Jansen
10 cm

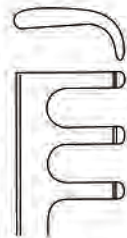

20-3983
47 mm



20-3984
3 cm



20-3984
Fig. 1



20-3985
4.5 cm

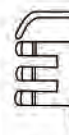

20-3985
Fig. 2



20-3986
6 cm



20-3986
Fig. 3



Wound Spreaders, self-retaining



20-3987-20-3988
Scalp-Contour
13.5 cm

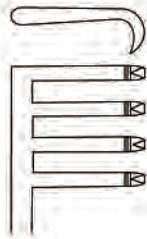

20-3987
13.5 cm

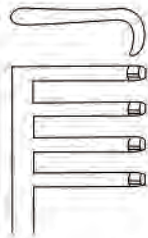

20-3988
13.5 cm

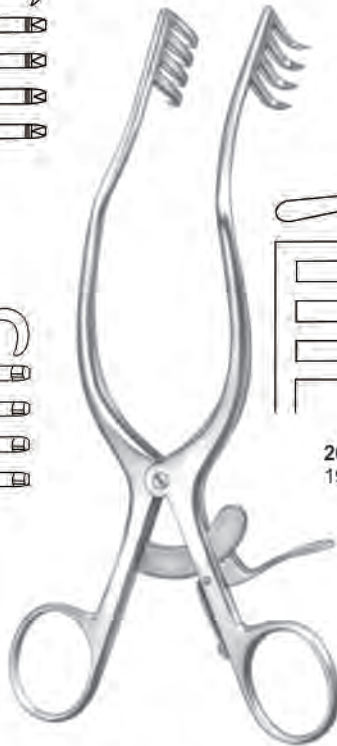

20-3989
Anderson-Adson
19 cm



20-3989
19 cm



20-3990-20-3991
Weitlaner
20 cm

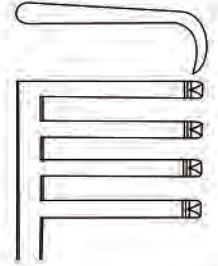

20-3990
20 cm

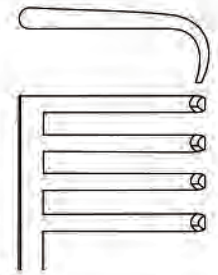

20-3991
20 cm



20-3992-20-3995
Adson

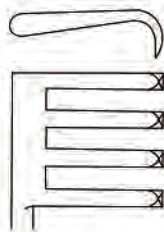

20-3992
26 cm

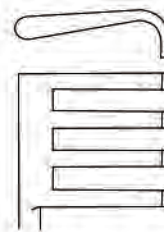

20-3993
26 cm

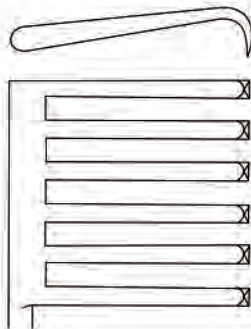

20-3994
29 cm

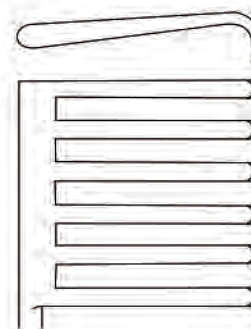

20-3995
29 cm

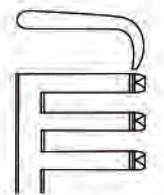

20-3996
11 cm

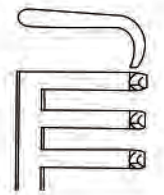

20-3997
11 cm



20-3996-20-3997
Weitlaner
11 cm



Wound Spreaders, self-retaining



M.F.ELAHI MEDICAL CO
SERVING WORLDWIDE SURGICAL INSTRUMENTS

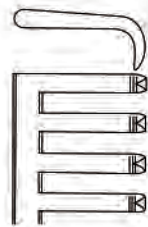
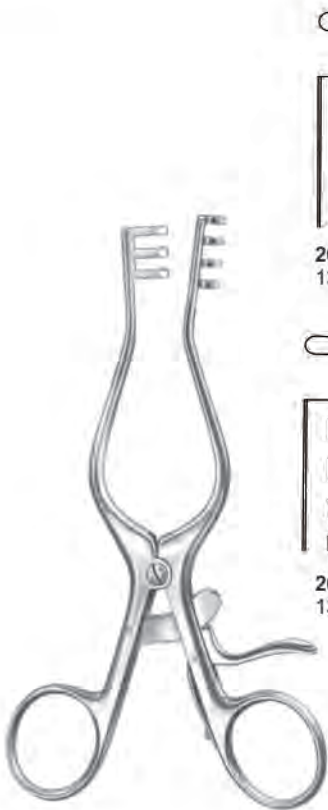

20-3998
13,5 cm

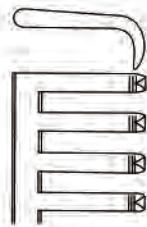

20-3999
16 cm

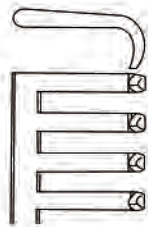

20-4000
13,5 cm

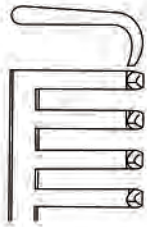

20-4001
16 cm

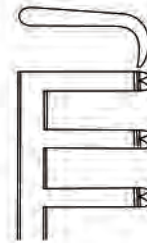

20-4002
40 mm

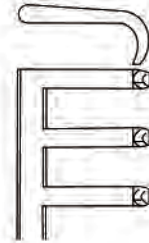

20-4003
40 mm

20-3998-20-4001
Scalp-Contour
13.5 cm

20-4002-20-4003
Weitlaner-Wullstein
13 cm

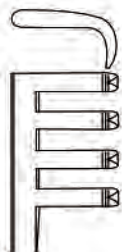

20-4004
80 mm

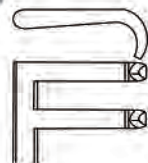

20-4005
37 mm

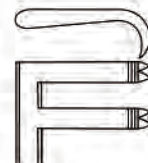

20-4006
37 mm

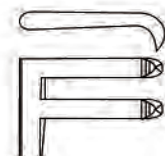

20-4007
37 mm

20-4004
Mollison
15.5 cm

20-4005-20-4006
Plester
13 cm

20-4007
Plester
10.5 cm



Wound Spreaders, self-retaining



M.F.ELAHI MEDICAL CO
SERVING WORLDWIDE SURGICAL INSTRUMENTS

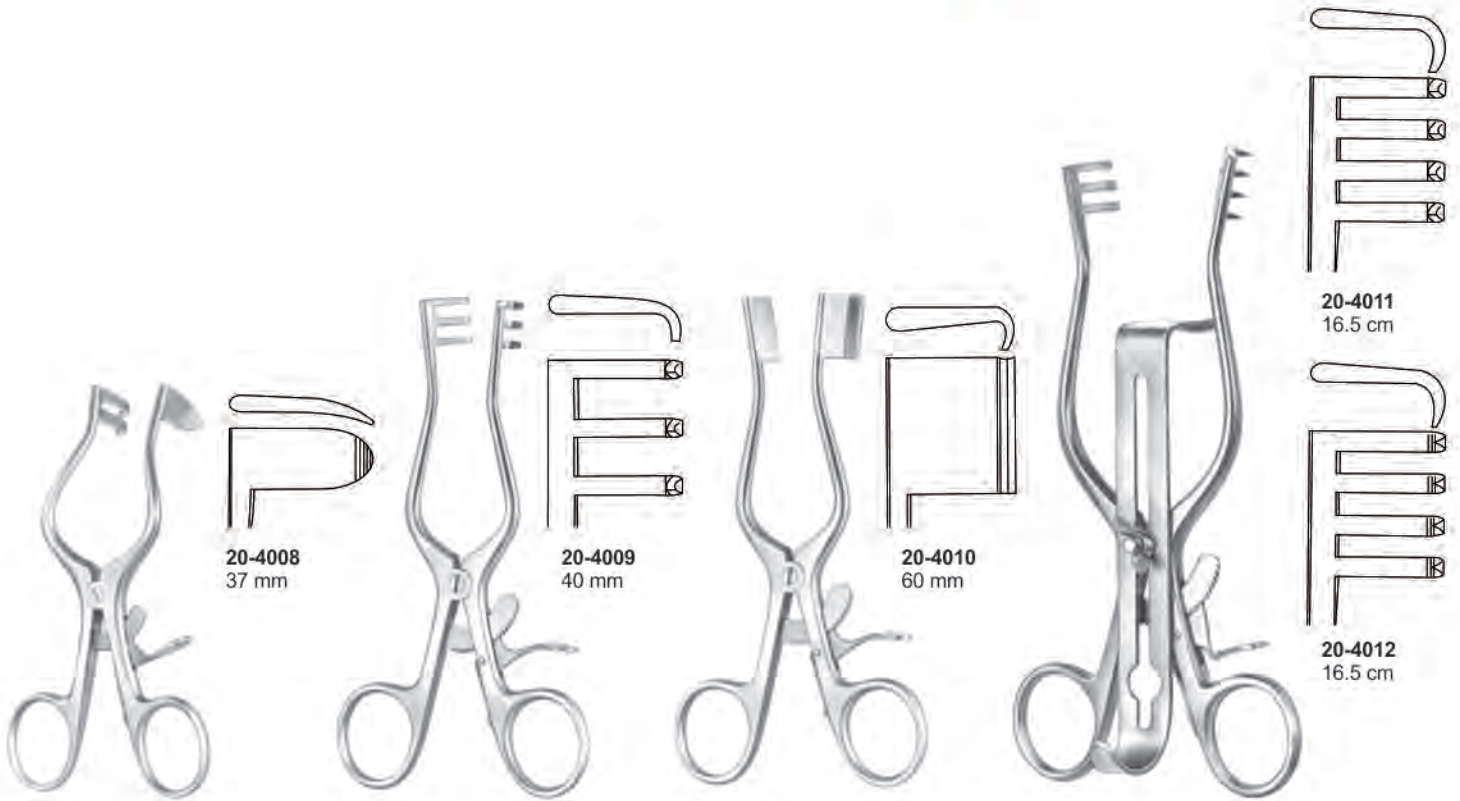

20-4008
Plester
10.5 cm

20-4008
37 mm

20-4009
Milligan
13.5 cm

20-4009
40 mm

20-4010
Weitlaner-Baby
13.5 cm

20-4010
60 mm

20-4011-20-4012
Henley
16.5 cm

20-4011
16.5 cm

20-4012
16.5 cm



20-4012-20-4019
Adson
14 cm

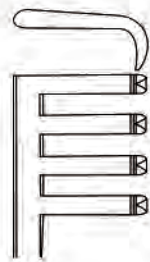

20-4012
14 cm

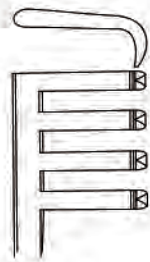

20-4013
16.5 cm

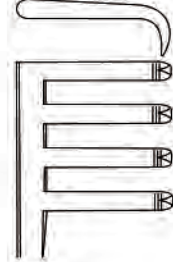

20-4014
21 cm

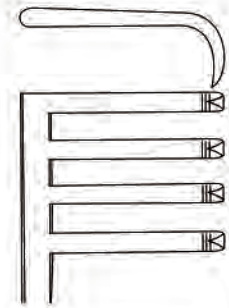

20-4015
24.5 cm

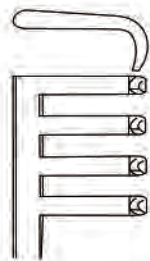

20-4016
14 cm



20-4017
16.5 cm

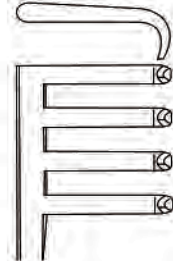

20-4018
21 cm

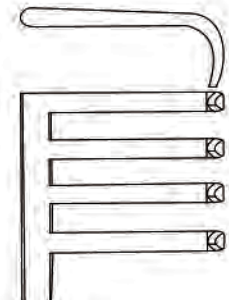

20-4019
24.5 cm



Wound Spreaders, self-retaining



M.F.ELAHI MEDICAL CO
SERVING WORLDWIDE SURGICAL INSTRUMENTS



20-4020
4 cm



20-4021
4.5 cm



20-4022
5 cm



20-4023
5.5 cm



20-4024
6 cm



20-4025
6 cm



20-4026
5.5 cm



20-4027
5 cm



20-4028
4.5 cm



20-4029
4 cm

20-4020
Cloward

20-4025-20-4029
Cloward

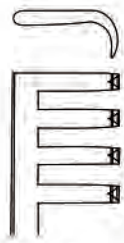

20-4030



20-4031

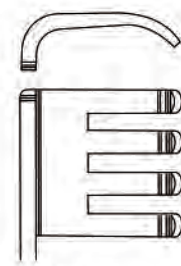
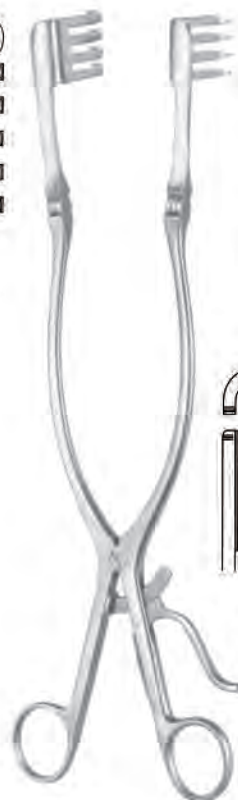

20-4032
31 cm

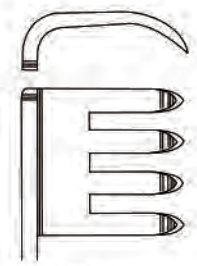

20-4033
31 cm

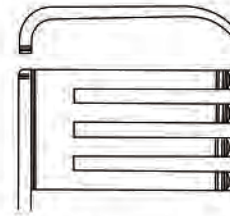

20-4034
30.5 cm

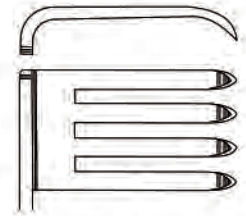

20-4035
30.5 cm

20-4030
Beckmann
32 cm

20-4031
Adson
33 cm

20-4032-20-4035
Beckman-Adson



Wound Spreaders, self-retaining



M.F.ELAHI MEDICAL CO
SERVING WORLDWIDE SURGICAL INSTRUMENTS



20-4036
Beckman-Eaton
32 cm

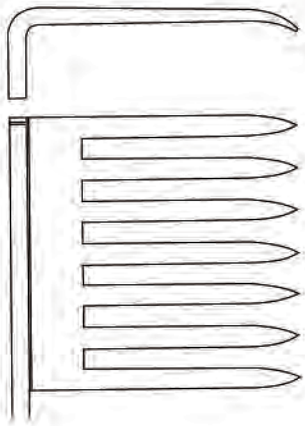

20-4037-20-4038
Martin

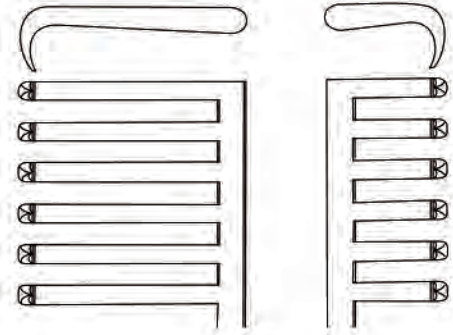

20-4037
28.5 cm

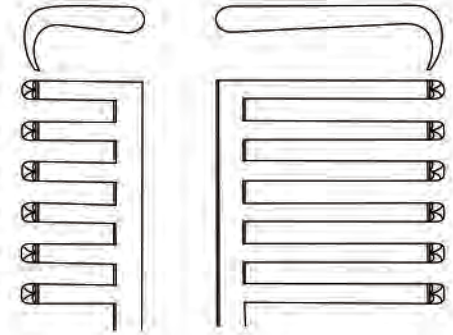

20-4038
28.5 cm



20-4039
Gelpi
13 cm



20-4040
Gelpi
18 cm

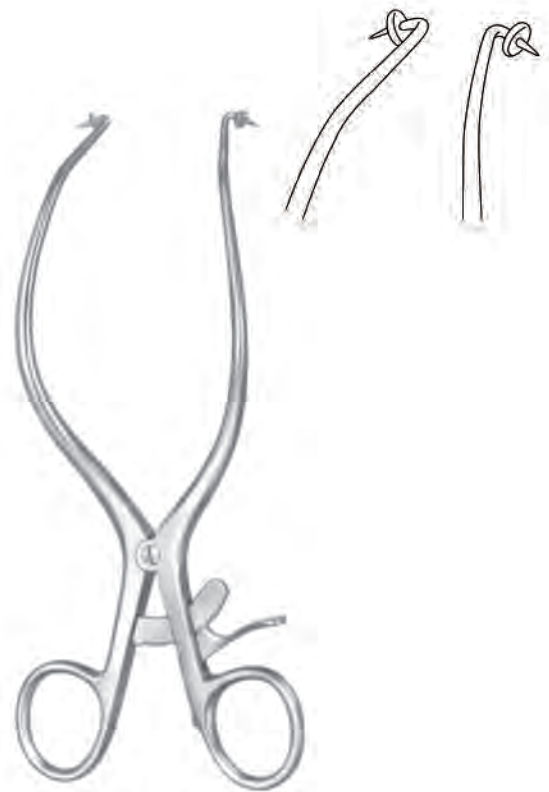

20-4041
Gelpi
18.5 cm



Wound Spreaders, self-retaining,
Abdominal Retractors



M.F. ELAHI MEDICAL CO
SERVING WORLDWIDE SURGICAL INSTRUMENTS



20-4042
Collin, Baby
20 cm
80 mm



20-4043
Collin
22.5 cm
80 mm



20-4044
Collin
24 cm
80 mm



20-4045
Collin
31 cm
130 mm



20-4046

20-4046-20-4047
Ricard
55 x 70 mm
80 x 90 mm



20-4047

20-4048
Balfour
20 cm



Abdominal Retractors



M.F.ELAHI MEDICAL CO
SERVING WORLDWIDE SURGICAL INSTRUMENTS



20-4049
Balfour
20 cm
200 mm



20-4050
Balfour
20 cm
180 mm



20-4051
Gosset
16.5 cm
160 mm



20-4052
Gosset-Baby
12.5 cm
120 mm



Abdominal Retractors



M.F. ELAHI MEDICAL CO
SERVING WORLDWIDE SURGICAL INSTRUMENTS

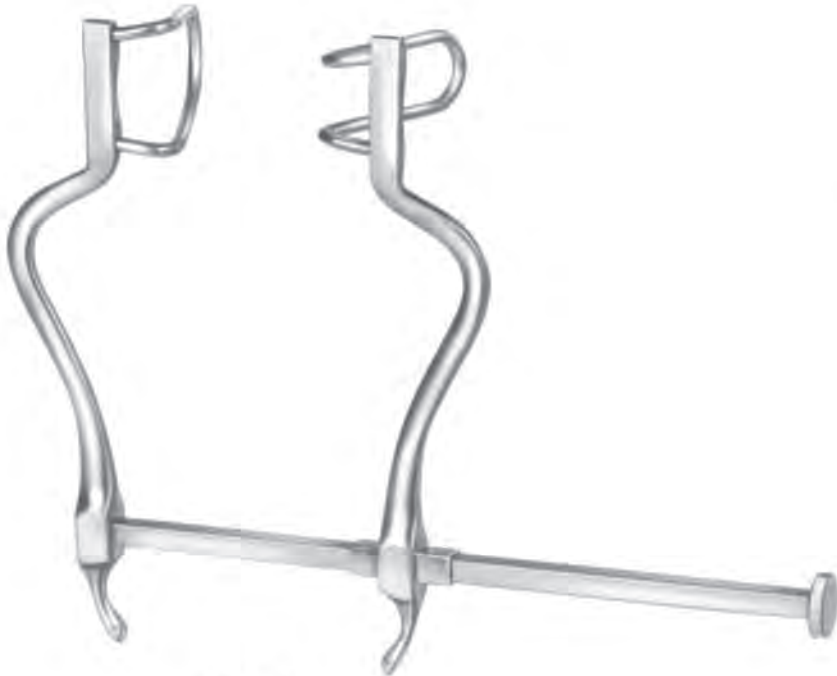

20-4053
Gosset
18.5 cm
140 mm



20-4054
Balfour-Baby
18.5 cm
95 mm

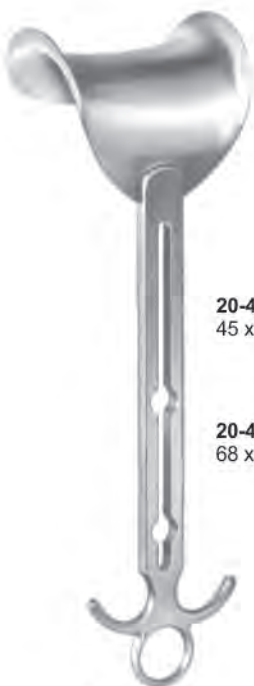

20-4055
45 x 80 mm

20-4056
68 x 85 mm

20-4055-20-4056
Balfour



20-4057
40 x 68 mm

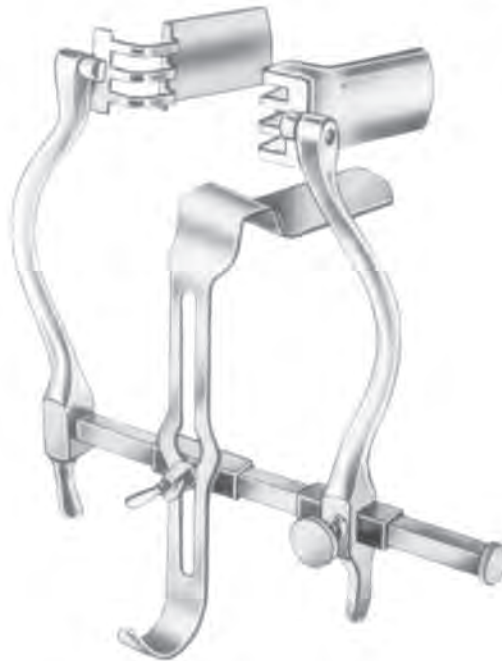

20-4058
Judd-Masson



20-4059
Doyen
45 x 95 mm
55 x 105 mm



Abdominal Retractors



M.F.ELAHI MEDICAL CO
SERVING WORLDWIDE SURGICAL INSTRUMENTS

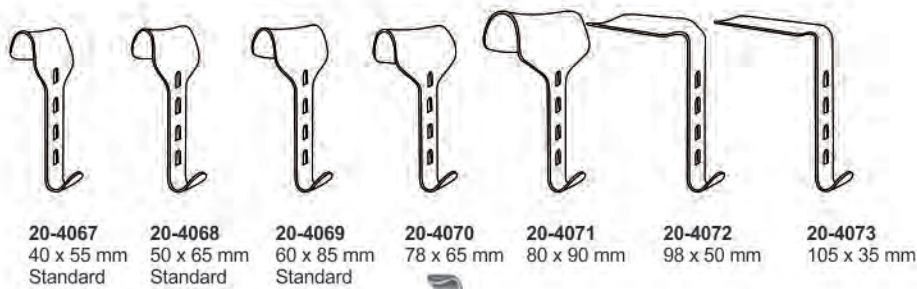
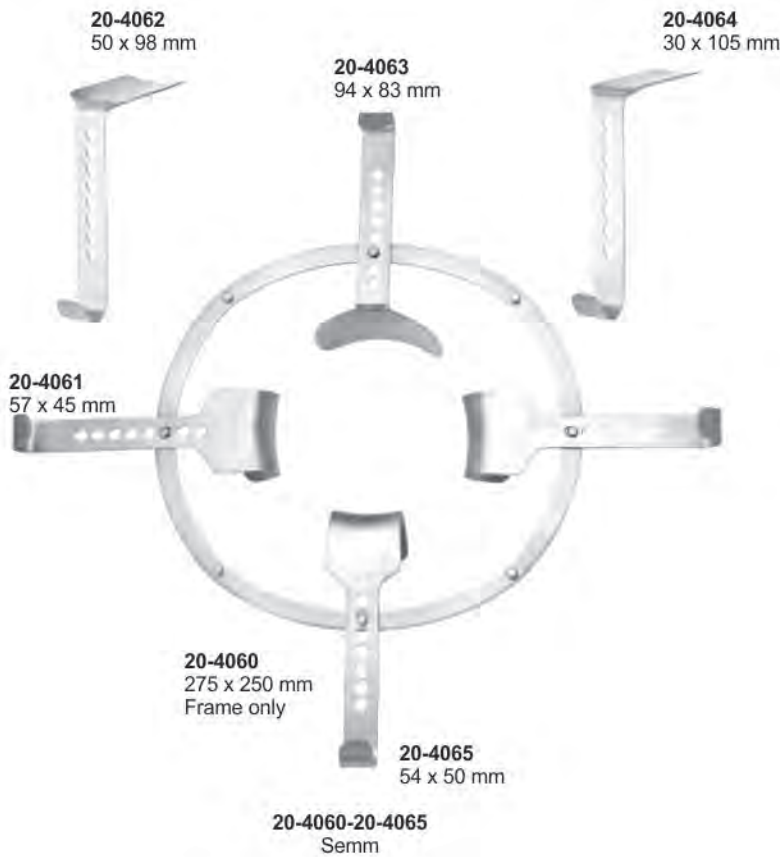

20-4067 40 x 55 mm Standard
 20-4068 50 x 65 mm Standard
 20-4069 60 x 85 mm Standard
 20-4070 78 x 65 mm
 20-4071 80 x 90 mm
 20-4072 98 x 50 mm
 20-4073 105 x 35 mm

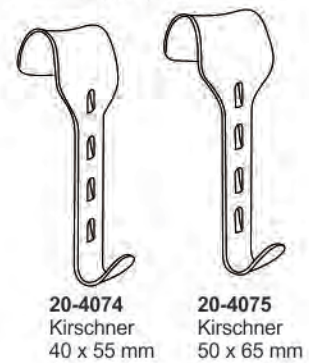

20-4074 Kirschner 40 x 55 mm
 20-4075 Kirschner 50 x 65 mm

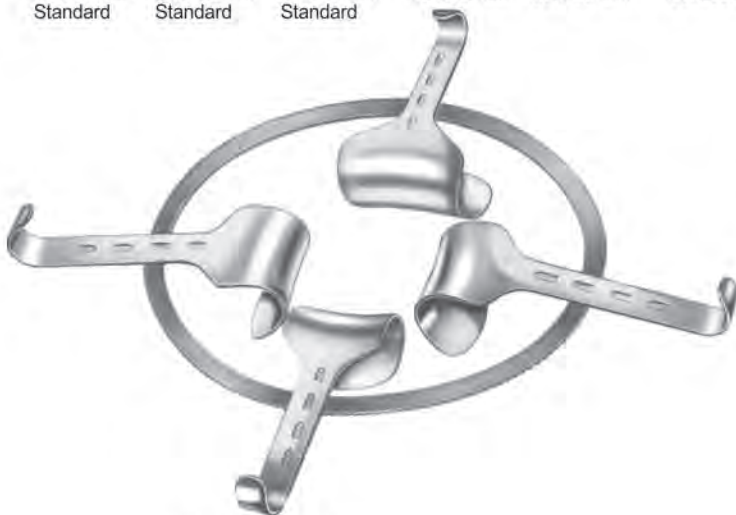

20-4067-20-4073
Kirschner
340 x 240 mm

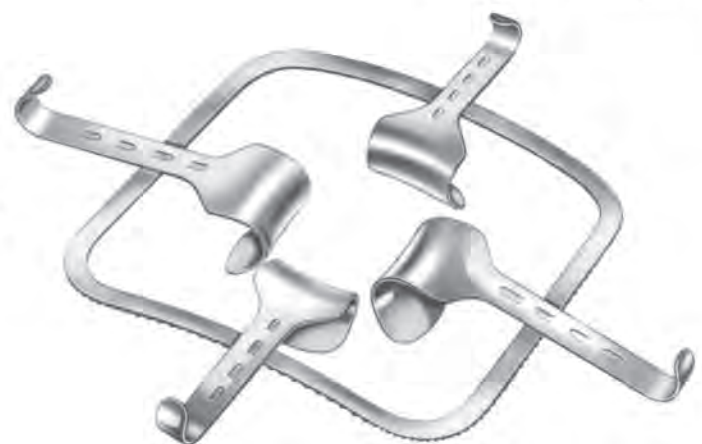

20-4074-20-4075
Kirschner
240 x 240 mm



Milium Knife, Lupus Instruments



M.F.ELAHI MEDICAL CO
SERVING WORLDWIDE SURGICAL INSTRUMENTS

21-4100
13 cm

21-4101



21-4100-21-4101
Moncorps



21-4102
Vidal
13 cm

21-4103
Fig. 1

21-4104
Fig. 2

21-4105
Fig. 3

21-4106
Fig. 4

21-4103-21-4106
Fox
14 cm



21-4107-21-4112
Wolff
14 cm

21-4107
Fig. 1

21-4108
Fig. 2

21-4109
Fig. 3

21-4110
Fig. 4

21-4111
Fig. 5

21-4112
Fig. 6

21-4114
Fig. 1

21-4115
Fig. 2

21-4116
Ø 2.0 mm

21-4117
Ø 3.0 mm

21-4118
Ø 4.0 mm

21-4119
Ø 5.0 mm

21-4120
Ø 6.0 mm

21-4121
Ø 7.0 mm

21-4122
Ø 8.0 mm



21-4113
Kilner
14.5 cm



21-4114-21-4115
Gillies
18 cm



21-4116-21-4122
Keyes
11 cm



21-4123
Unna
14.5 cm



Milium Knife, Lupus Instruments



M.F.ELAHI MEDICAL CO
SERVING WORLDWIDE SURGICAL INSTRUMENTS



21-4124
Unna
14 cm



21-4125
Saalfeld
11 cm



21-4126
Saalfeld
14.5 cm

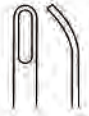

21-4127
Schamberg
9.5 cm



21-4128
Katsch
16 cm



21-4129
Unna-Vidal
11 cm



21-4130
Gillesberger
14.5 cm



21-4130
Fig. 1

21-4131
Fig. 2

21-4132
Fig. 3

21-4130-21-4132
Piffard
14.5 cm



Tracheal Dilators



M.F.ELAHI MEDICAL CO
SERVING WORLDWIDE SURGICAL INSTRUMENTS

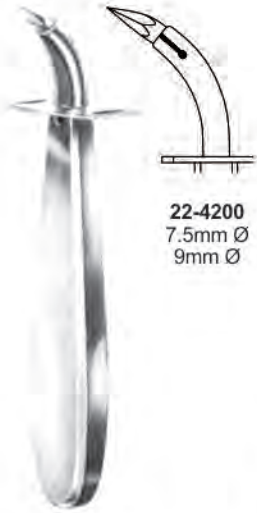

22-4200
7.5mm Ø
9mm Ø

22-4200
Uckermann
13 cm

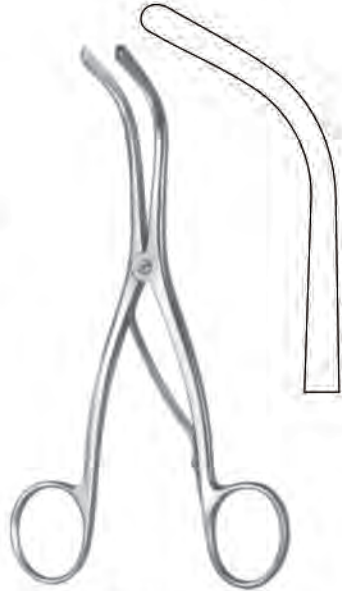

22-4201
Trousseau
14.5 cm



22-4202
Laborde
14 cm



22-4203
Weerda
19 cm



22-4204
Bose
7 cm

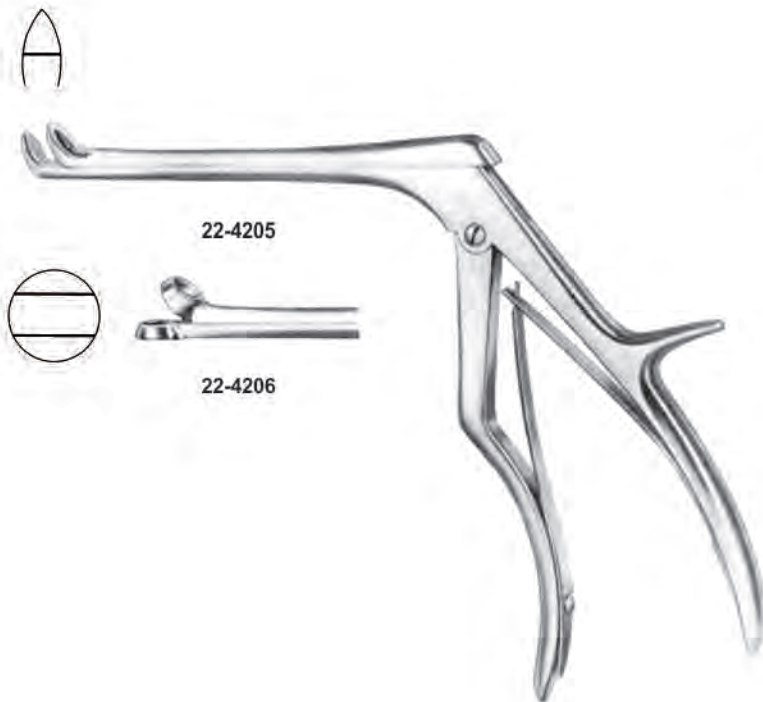

22-4205

22-4206



22-4207
Rose
15.5 cm

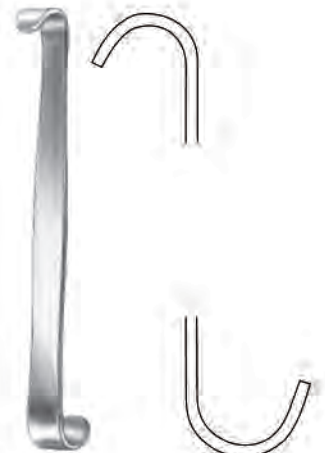

22-4208
Luer
11 cm



Tracheal Dilators, Tracheal Hooks, Tracheal Tubes



M.F. ELAHI MEDICAL CO
SERVING WORLDWIDE SURGICAL INSTRUMENTS

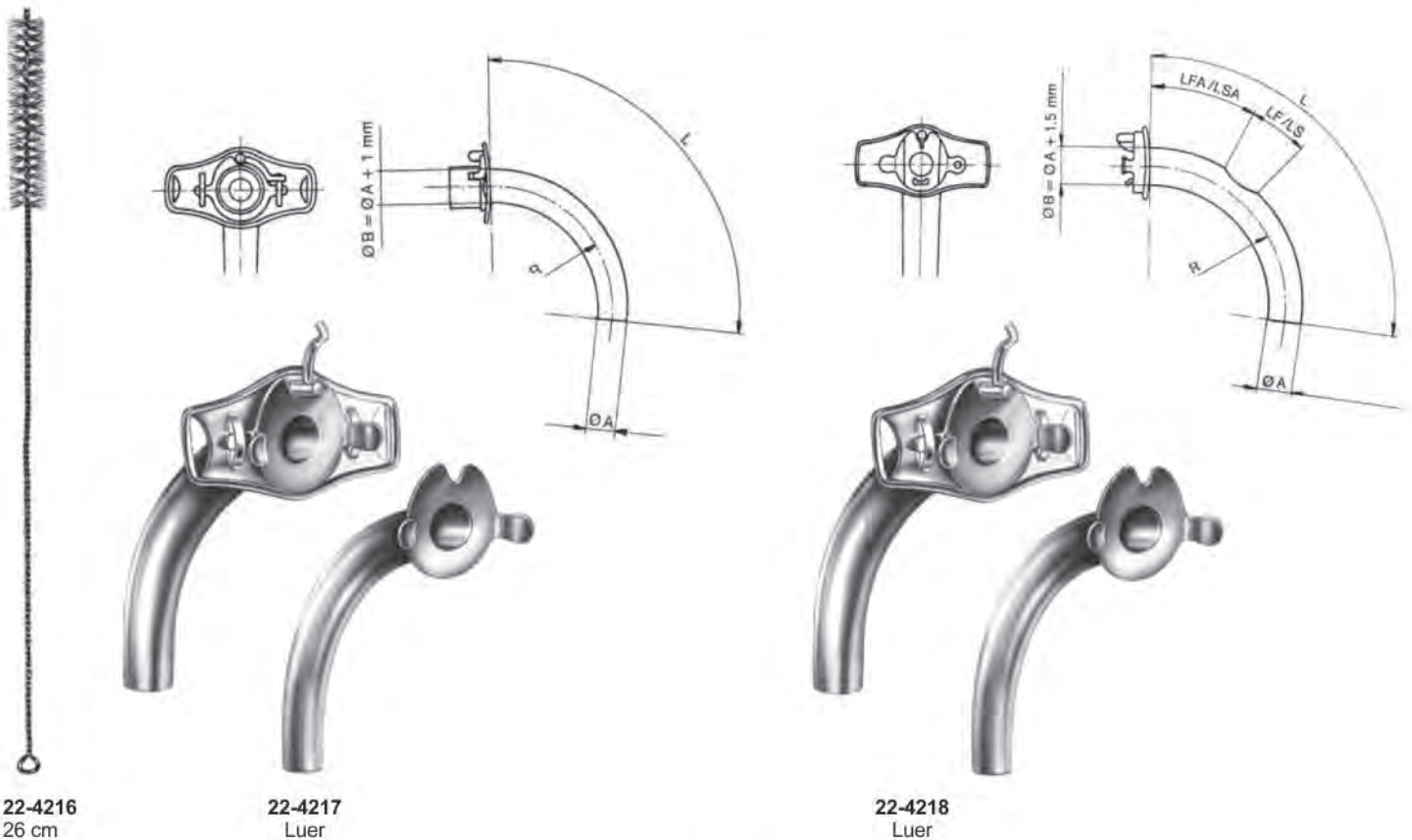

Tracheal Tubes, Speaking Tubes



M.F. ELAHI MEDICAL CO
SERVING WORLDWIDE SURGICAL INSTRUMENTS

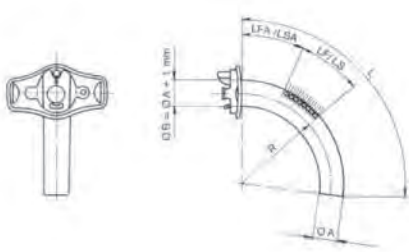

22-4219
Luer

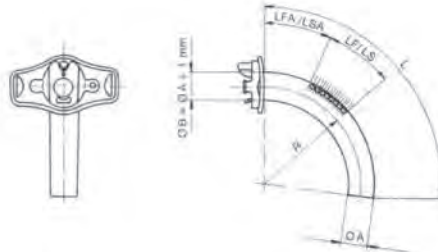

22-4220
Luer

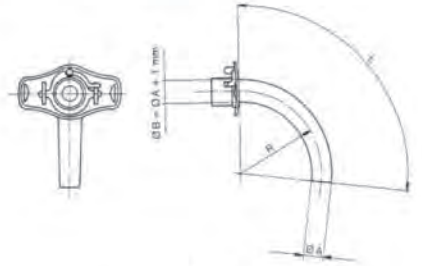

22-4221
Luer

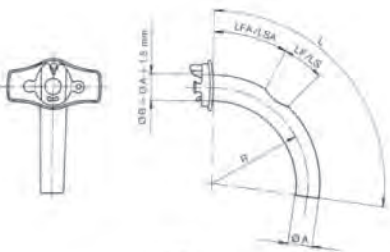

22-4222
Chevalier-Jackson

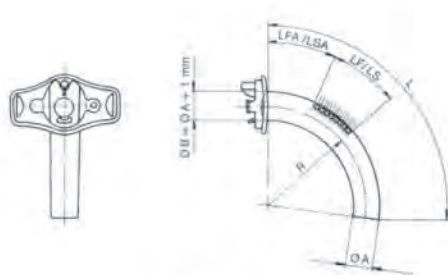

22-4223
Chevalier-Jackson

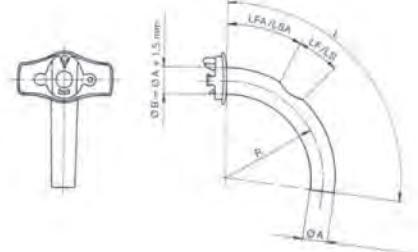

22-4224
Speaking Tubes



Eye Speculas



M.F.ELAHI MEDICAL CO
SERVING WORLDWIDE SURGICAL INSTRUMENTS



23-4300
Children
7 cm

Weiss



23-4301
Children
9 cm



23-4302
Children
7 cm

Weiss



23-4303
Children
9 cm



23-4304
Park
8 cm



23-4305
Park-Guyton
8 cm



23-4306
Park-Maumenee
8 cm



Barraquer (Colibri)
23-4307
Children
3 cm



23-4308
Barraquer
4 cm



23-4310
Bowman
7 cm



23-4311
Sauer
3 cm



23-4312
Goldstein
3 cm



23-4313
Pley
41 cm

For left eye

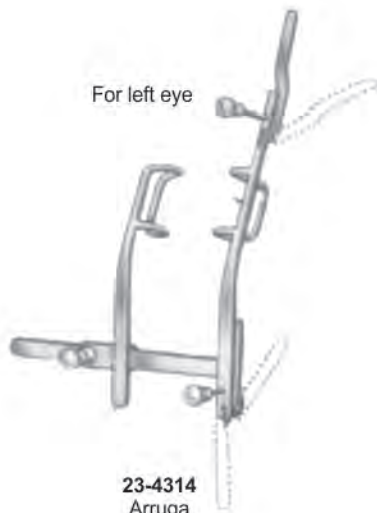

23-4314
Arruga
7 cm

For right eye



23-4315
Arruga
7 cm

Eye Speculas



M.F. ELAHI MEDICAL CO
SERVING WORLDWIDE SURGICAL INSTRUMENTS



23-4316
Mellinger-Axenfeld
7 cm



23-4317
Mellinger-Axenfeld
7 cm



23-4318
Children
5 cm



Mellinger 23-4319
Adults
7 cm



23-4320
Children
5 cm

Mellinger Beard 23-4321
Adults
7 cm



23-4322
Mellinger-Axenfeld
7 cm



23-4323
Children
6 cm



Mellinger 23-4324
Adults
9 cm



23-4325
Lancaster
8 cm



23-4326
Children
7 cm

Williams 23-4327
Adults
8 cm



23-4328
Lister-Burch
8 cm



23-4329
Weiss
8 cm



23-4330
Murdock
5 cm



23-4331
Mueller
7 cm



23-4332
Critchett
6 cm



23-4333
Castroviejo
8 cm



Eye Speculas



23-4334-23-4349
Mod. Hamburg



23-4334
Graefe



23-4335



23-4336
Weber



23-4337



23-4338
Bowman
0.4 mm



23-4339
Bowman
0.5 mm



23-4340
Bowman
0.6 mm



23-4341
Bowman
0.7 mm



23-4342
Bowman
0.8 mm

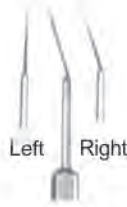

23-4343
Bowman



23-4344
Knapp



23-4345
Knapp



23-4346
Knapp



23-4347
Ziegler
5 mm



23-4348
Ziegler
6 mm



23-4349
Ziegler
7 mm



23-4350-23-4365
Mod. Hamburg



23-4350
Zigler
3½ mm



23-4351
Sato



23-4352
Sichel



23-4353
Graefe



23-4354
Graefe



23-4355



23-4356
Kuhnt



23-4357



23-4358



23-4359
Paton



23-4360
Elsching



23-4361
Took



23-4362
Desmarres



23-4363
Desmarres



23-4364
Desmarres



23-4365
Gill



Calipers, Markers, Punches Chisels



M.F. ELAHI MEDICAL CO
SERVING WORLDWIDE SURGICAL INSTRUMENTS



23-4366
Castroviejo



23-4367
Castroviejo
20 cm



23-4368
Holth



23-4369
Haitz



23-4370
West
16 cm



23-4371
West
16 cm



23-4372
Connin-Amsler
13 cm



23-4373
Wilder



23-4374
Wilder



23-4375
Wilder



Suture Forceps, Trochoma and Chalazion Forceps



M.F.ELAHI MEDICAL CO
SERVING WORLDWIDE SURGICAL INSTRUMENTS



23-4376
Tuebingen
10 cm



23-4377
8.5 cm



23-4378
Paufigue
10 cm



23-4379
Barraquer
10.5 cm



23-4380
McPherson
10 cm



23-4381
McPherson
7.5 cm



23-4382
Knapp
11 cm



23-4383
Ayer
9 cm



23-4384
Ayer
9 cm



23-4385
Lambert
9 cm



23-4386-23-4388
Desmarres
9 cm



23-4386



23-4387



23-4388



Iridectomy Scissors



M.F.ELAHI MEDICAL CO
SERVING WORLDWIDE SURGICAL INSTRUMENTS

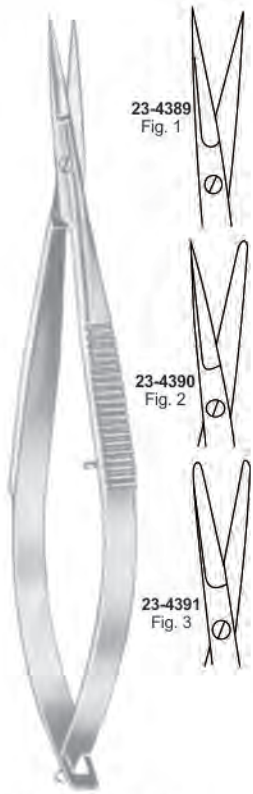

23-4389-23-4391
Noyes
12 cm



23-4392
Noyes
12 cm

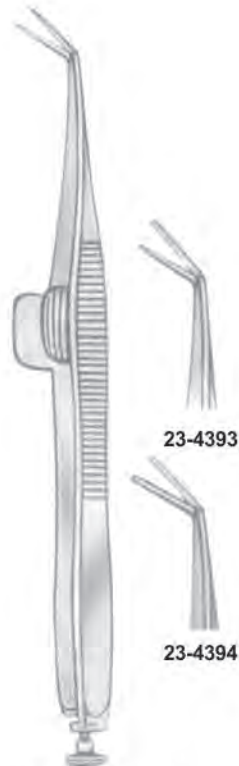

23-4393-23-4394
Wecker
11.5 cm



23-4395
Barraquer
5.5 cm



23-4396-23-4400
9 cm



23-4396



23-4397



23-4398



23-4399



23-4400



Straight

23-4401
Vannas
8 cm



Curved

23-4402
Vannas
8 cm



Angular

23-4403
Vannas
8 cm



Curved

23-4404
Vannas
8 cm



Straight

23-4405
8.5 cm



Curved

23-4406
8.5 cm



Iridectomy Scissors



M.F.ELAHI MEDICAL CO
SERVING WORLDWIDE SURGICAL INSTRUMENTS

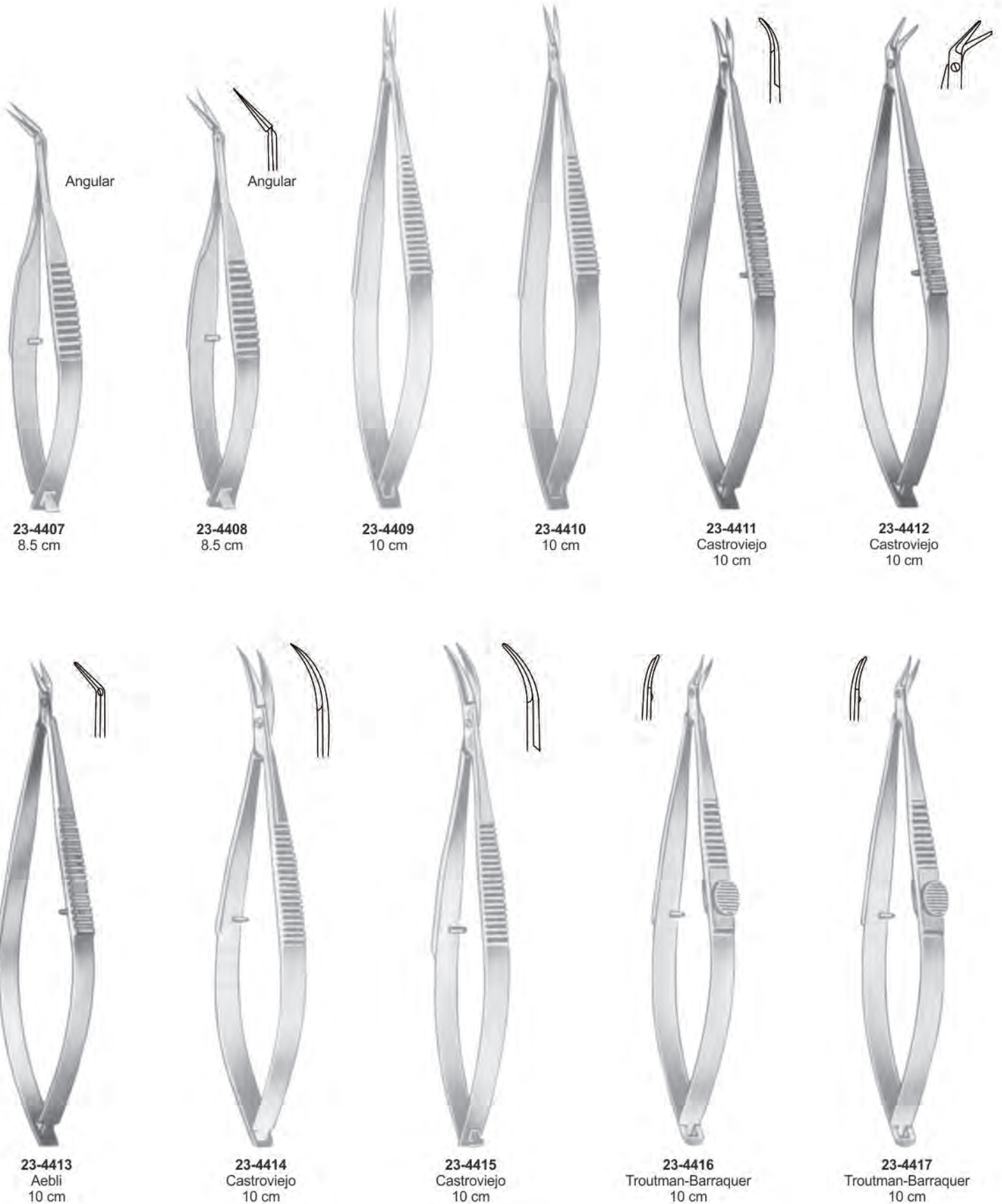

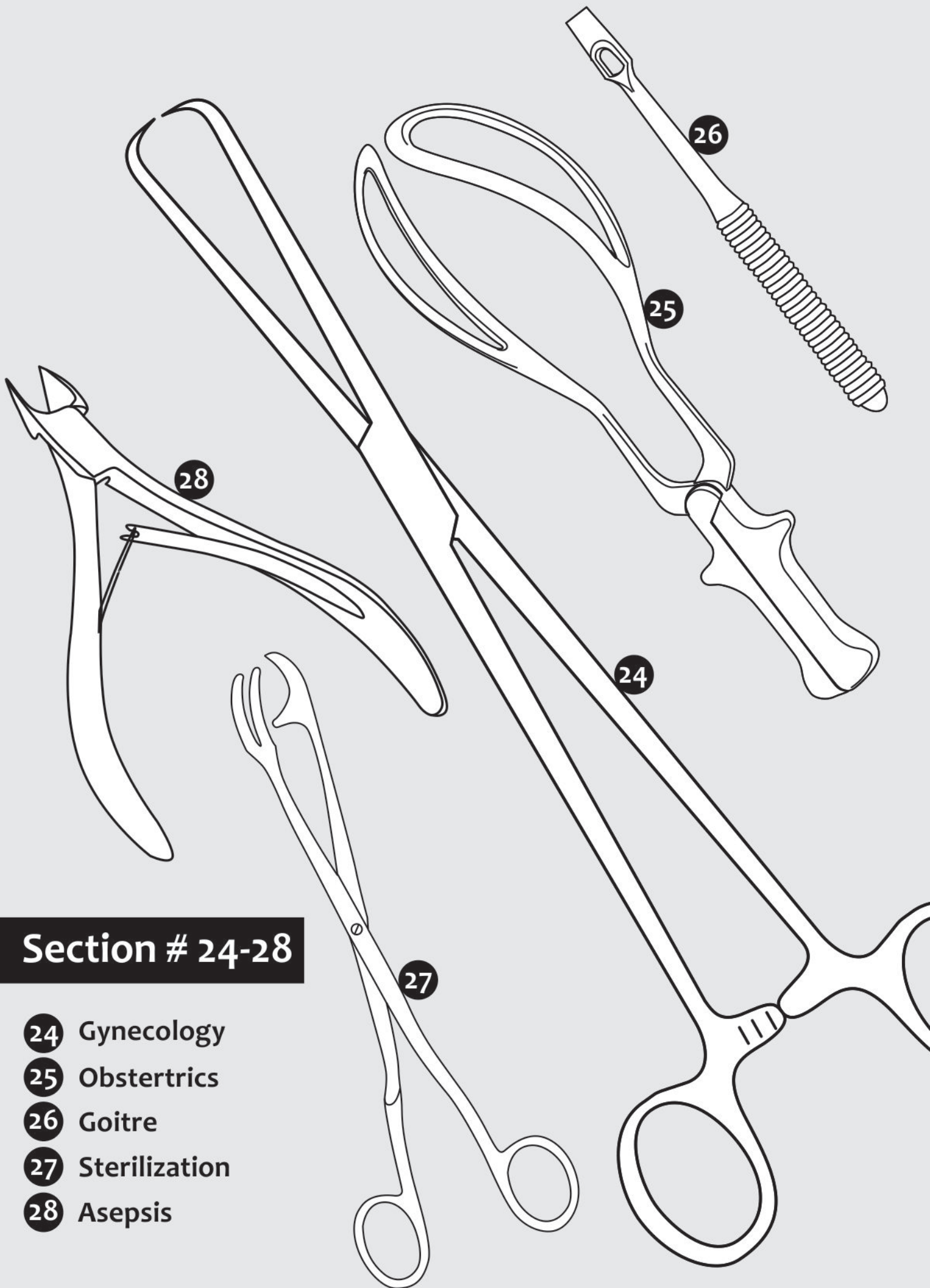

Section # 24-28

- 24** Gynecology
- 25** Obstetrics
- 26** Goitre
- 27** Sterilization
- 28** Asepsis



Vaginal Specula



24-4500
75 x 34 mm

24-4501
85 x 37 mm

24-4502
100 x 37 mm

24-4500-24-4502
Cusco



24-4503
75 x 32 mm

24-4504
85 x 37 mm

24-4505
100 x 35 mm

24-4503-24-4505
Cusco



24-4506
Cusco
75 x 18 mm



24-4507
90 x 22 mm

24-4508
100 x 25 mm

24-4509
105 x 27 mm

24-4507-24-4509
Cusco



24-4510
85 x 30 mm

24-4511
100 x 35 mm

24-4512
110 x 40 mm

24-4510-24-4512
Collin



24-4513
Collin
65 x 20mm



24-4517
Collin
55 x 10mm



24-4514
Collin-Landau
Medium 35 x 100 mm



24-4515
Small 30 x 85 mm
Medium 35 x 100 mm
Large 40 x 110 mm

24-4516
Collin



Vaginal Specula

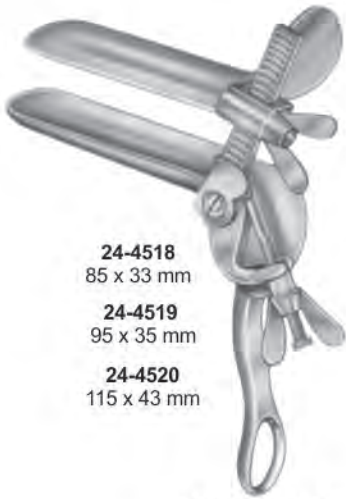

24-4518
85 x 33 mm
24-4519
95 x 35 mm
24-4520
115 x 43 mm

24-4518-24-4520
Trelat



24-4521
75 x 20 mm
24-4522
95 x 35 mm
24-4523
115 x 35 mm

24-4521-24-4523
Grave



24-4524
75 x 13 mm
24-4525
100 x 24 mm
24-4526
120 x 26 mm

24-4524-24-4526
Pederson

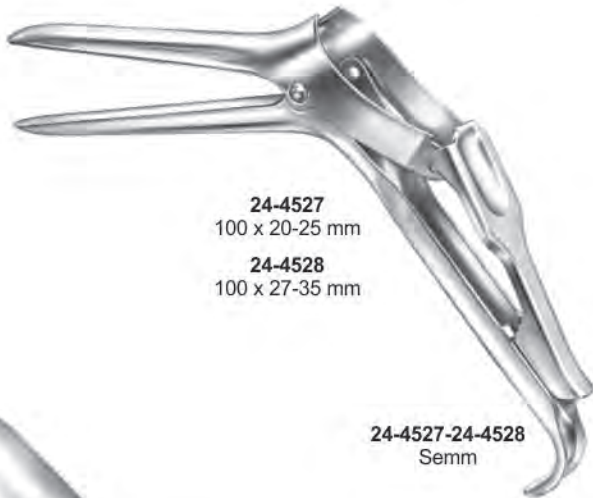

24-4527
100 x 20-25 mm
24-4528
100 x 27-35 mm

24-4527-24-4528
Semm



24-4529
90 - 30 mm
24-4530
110 x 30 mm

24-4529-24-4530
Nott

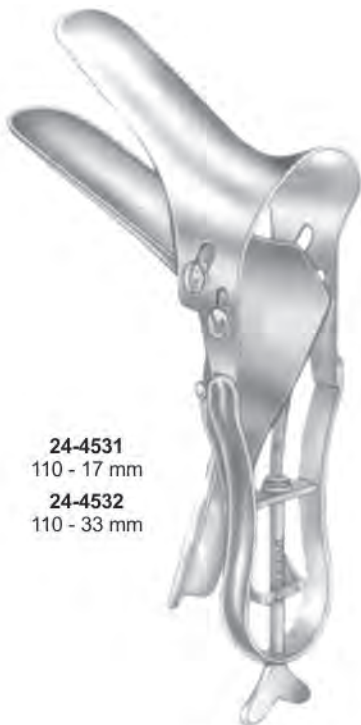

24-4531
110 - 17 mm
24-4532
110 - 33 mm

24-4531-24-4532
Seyffert



24-4533
Sakurai's



24-4534
110 - 33 mm

24-4534
Seyffert



Vaginal Specula, Vaginal Retractors



M.F. ELAHI MEDICAL CO
SERVING WORLDWIDE SURGICAL INSTRUMENTS



24-4535
63 x 32 mm

24-4536
76 x 32 mm

24-4537
89 x 38 mm

24-4535-24-4537
Sims (single ended)



24-4538-24-4540
Sims

24-4538
65 x 25 mm

24-4539
70 x 30 mm

24-4540
85 x 35 mm



24-4541-24-4543
Jackson

24-4541
75 x 38 mm

24-4542
90 x 38 mm

24-4543
100 x 38 mm



24-4544-24-4550
Eastman

24-4544
Fig. 1
75 X 35 mm

24-4545
Fig. 2
90 X 35 mm

24-4546
Fig. 3
100 X 35 mm

24-4547
Fig. 4
100 X 35 mm

24-4548
Fig. 4
75 X 40 mm

24-4549
Fig. 5
90 x 40 mm

24-4550
Fig. 5
100 x 40 mm



24-4551-24-4553
Kristeller

24-4551
Fig. 1
70 x 27 mm

24-4552
Fig. 2
80 x 30 mm

24-4553
Fig. 3
90 x 36 mm



24-4554-24-4556
Kristeller

24-4554
Fig. 1
75 x 23 mm

24-4555
Fig. 2
85 x 26 mm

24-4556
Fig. 3
100 x 32 mm

Vaginal Specula, Vaginal Retractors



M.F.ELAHI MEDICAL CO
SERVING WORLDWIDE SURGICAL INSTRUMENTS



24-4557
Fig. 1
24-4558
Fig. 2
24-4559
Fig. 3

24-4557-24-4559
Kristeller



24-4560
Fig. 1
105 x 18 mm
24-4561
Fig. 2
110 x 21 mm

24-4560-24-4561
Kristeller



24-4562
Fig. 1
110 x 14 mm
24-4563
Fig. 2
115 x 17 mm

24-4562-24-4563
Kristeller



24-4564
Fig. 1
24-4565
Fig. 2

24-4564-24-4565
Kristeller



24-4566
Fig. 1
105 x 26 mm
24-4567
Fig. 2
105 x 28 mm
24-4568
Fig. 3
105 x 33 mm

24-4566-24-4568
Kristeller

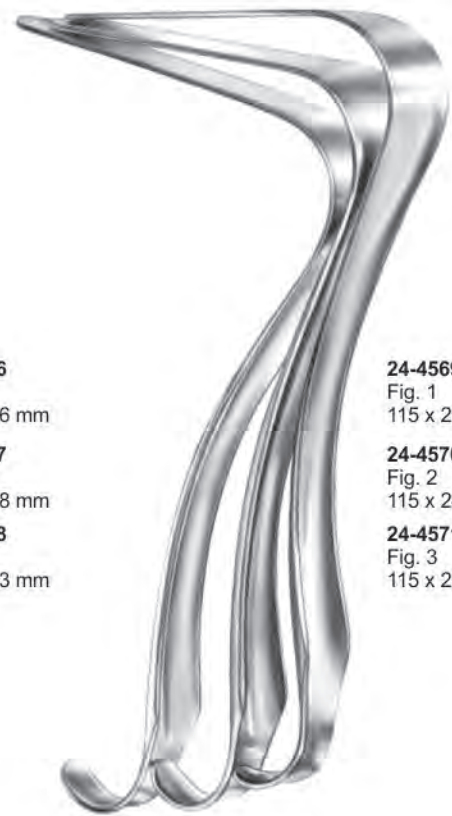

24-4569
Fig. 1
115 x 22 mm
24-4570
Fig. 2
115 x 24 mm
24-4571
Fig. 3
115 x 29 mm

24-4569-24-4571
Kristeller



Vaginal Specula, Vaginal Retractors



M.F. ELAHI MEDICAL CO
SERVING WORLDWIDE SURGICAL INSTRUMENTS



24-4572
Fig. 1

24-4573
Fig. 2

24-4574
Fig. 3

24-4572-24-4574
Kristeller



24-4575
Fig. 1
110 x 28 mm

24-4576
Fig. 2
110 x 30 mm

24-4577
Fig. 3
110 x 36 mm

24-4575-24-4577
Kristeller



24-4578
Fig. 1
70 x 40 mm

24-4579
Fig. 2
90 x 40 mm

24-4578-24-4579
Kallmorgen



24-4580
Fig. 1
70 x 37 mm

24-4581
Fig. 2
90 x 37 mm

24-4580-24-4581
Kallmorgen



24-4582
Fig. 1

24-4583
Fig. 2

24-4582-24-4583
Kallmorgen



24-4584
Fig. 1
58 x 35 mm

24-4585
Fig. 2
88 x 35 mm

24-4586
Fig. 3
118 x 35 mm

24-4587
Fig. 1
60 x 47 mm

24-4588
Fig. 2
78 x 47 mm

24-4589
Fig. 3
120 x 47 mm

24-4590
Fig. 4
165 x 47 mm

24-4591
Fig. 1
55 x 60 mm

24-4592
Fig. 2
85 x 60 mm

24-4593
Fig. 3
115 x 60 mm

24-4584-24-4593
Doyen



Vaginal Specula, Vaginal Retractors,
Uterine Dilators



M.F.ELAHI MEDICAL CO
SERVING WORLDWIDE SURGICAL INSTRUMENTS



24-4594
Auvard
23.5 cm



24-4595
Auvard
80 x 38 mm



24-4596-24-4600
Breisky

- 24-4596
29.5 cm
100 x 20 mm
- 24-4597
29.5 cm
100 x 25 mm
- 24-4598
29.5 cm
100 x 30 mm
- 24-4599
29.5 cm
100 x 35 mm
- 24-4600
29.5 cm
100 x 40 mm



24-4601
Doyen
25 cm



24-4602
Hegar
18.5 cm



Vaginal Specula, Vaginal Retractors,
Uterine Dilators



M.F.ELAHI MEDICAL CO
SERVING WORLDWIDE SURGICAL INSTRUMENTS



24-4603
Hegar
20 cm



24-4604
Hegar



24-4605
Hegar



24-4606
Hank
26.5 cm



24-4607
Hank



Fistula Hooks, Myoma Screws, Myoma Knife



M.F. ELAHI MEDICAL CO
SERVING WORLDWIDE SURGICAL INSTRUMENTS

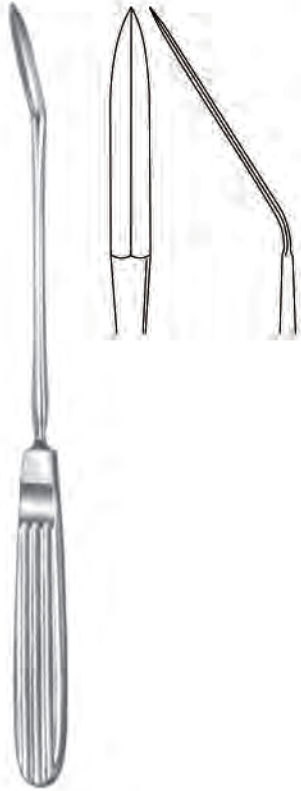

24-4608
Ayre
23.5 cm



24-4609
Simon
21.5 cm



24-4610
Simon
21.5 cm



24-4611
Emmett
Fig. 3
23 cm



24-4612
Doyen
17 cm
Ø 20 mm



24-4613
Doyen
15 cm
Ø 29 mm



24-4614
Segond
28 cm



Uterine Biopsy Forceps, IUP Grasping Forceps



M.F. ELAHI MEDICAL CO
SERVING WORLDWIDE SURGICAL INSTRUMENTS

23.0cm

4 x 8mm

195 mm

24-4615
Wittner

24-4616
Alexander

230 mm

24-4617
Kevorkian

225 mm

24-4618
Schumacher

250 mm

24-4619
Schumacher

24-4621
27 cm
Ø 3,0 mm
225 mm

24-4620
32 cm
Ø 3,0 mm
270 mm



Uterine Scoops, Uterine Curettes, Uterine Tenaculum Forceps, Amniotome



M.F.ELAHI MEDICAL CO
SERVING WORLDWIDE SURGICAL INSTRUMENTS



24-4622
Fig. 1
23 cm
10 x 7 mm

24-4623
Fig. 2
23.5 cm
12 x 18 mm

24-4628
Fig. 1
10 x 7 mm

24-4629
Fig. 2
12 x 18 mm

24-4624
Fig. 3
24 cm
13 X 10 mm

24-4625
Fig. 4
24 cm
16 x 12 mm

24-4630
Fig. 3
13 X 10 mm

24-4631
Fig. 4
16 x 12 mm

24-4626
Fig. 5
24 cm
18 x 13 mm

24-4627
Fig. 6
24 cm
20 x 15 mm

24-4632
Fig. 5
18 x 13 mm

24-4633
Fig. 6
20 x 15 mm



24-4634
Blake
27.5 cm
8 mm

24-4622-24-4627
Simon

24-4628-24-4633
Simon
30 cm



24-4635
Schröder
25.5 cm



24-4636
Braun
26 cm



24-4637
Duplay
28 cm

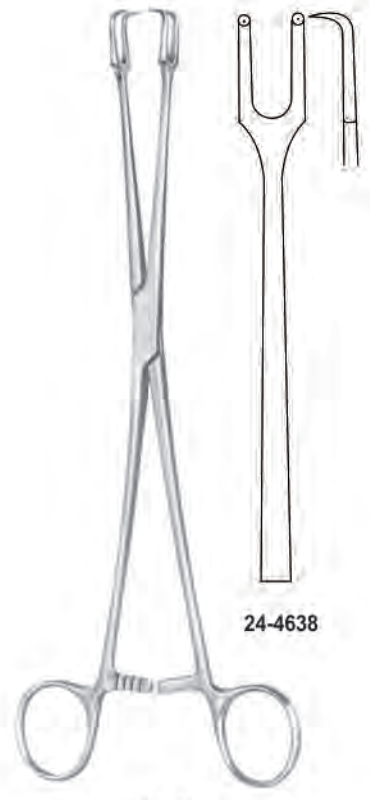

24-4638
Schröder
25 cm



Uterine Tenaculum Forceps



M.F. ELAHI MEDICAL CO
SERVING WORLDWIDE SURGICAL INSTRUMENTS

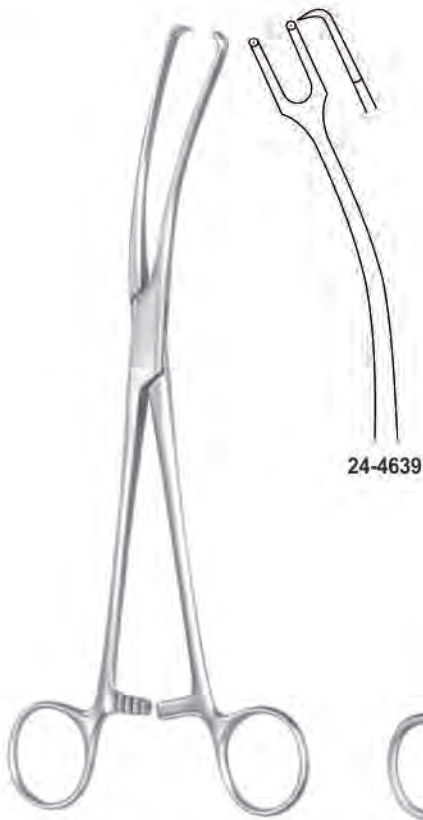

24-4639

24-4639
Teale
23 cm

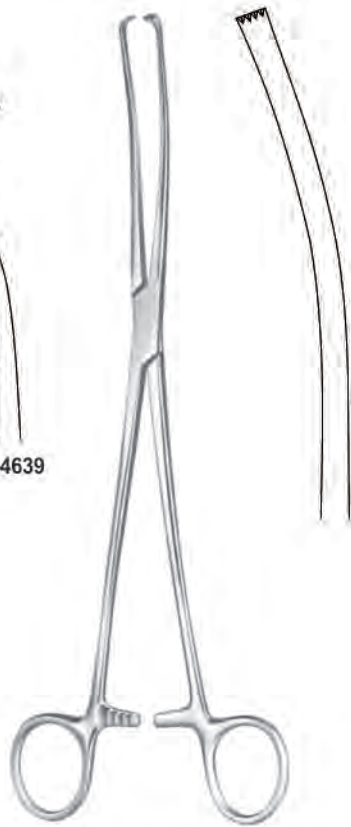

24-4640
Iowa
26 cm

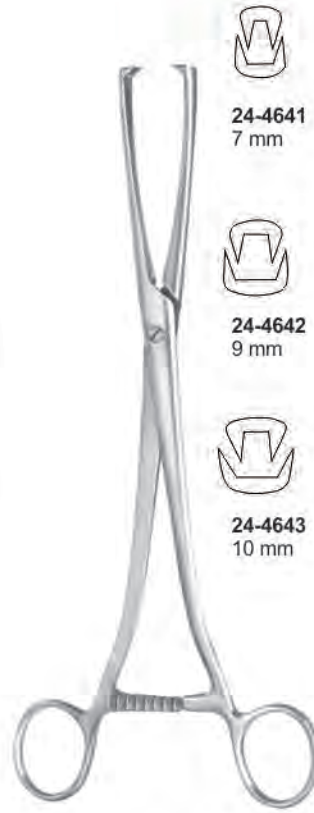

24-4641-24-4643
Museux
24 cm



24-4644
Jacobs
21 cm



24-4645
Braun
16 cm



24-4646
Czerny
21 cm



24-4647
Kelly
31.5 cm



24-4648
Heywood-Smith
26 cm





Uterine Curettes



24-4649
Recamier

24-4650
Recamier

24-4651
Sims

24-4652
Sims

sharp, rigid	Fig	width	sharp, malleable
24-4649	Fig. 00	5 mm	24-4650
24-4649-A	Fig. 0	6 mm	24-4650-A
24-4649-B	Fig. 1	7 mm	24-4650-B
24-4649-C	Fig. 2	8 mm	24-4650-C
24-4649-D	Fig. 3	9 mm	24-4650-D
24-4649-E	Fig. 4	11 mm	24-4650-E
24-4649-F	Fig. 5	12 mm	24-4650-F
24-4649-G	Fig. 6	14 mm	24-4650-G
24-4649-H	Fig. 7	15 mm	24-4650-H
24-4649-I	Fig. 8	16 mm	24-4650-I
24-4649-J	Fig. 9	19 mm	24-4650-J
24-4649-K	Fig. 10	20 mm	24-4650-K
24-4649-L	Fig. 11	21 mm	24-4650-L
24-4649-M	Fig. 12	23 mm	24-4650-M
24-4649-N	Fig. 13	25 mm	24-4650-N
24-4649-O	Fig. 14	30 mm	24-4650-O
24-4649-P	Fig. 15	35 mm	24-4650-P
24-4649-Q	Fig. 16	40 mm	24-4650-Q

sharp, rigid	Fig	width	sharp, malleable
24-4651	Fig. 00	5 mm	24-4652
24-4651-A	Fig. 0	6 mm	24-4652-A
24-4651-B	Fig. 1	7 mm	24-4652-B
24-4651-C	Fig. 2	8 mm	24-4652-C
24-4651-D	Fig. 3	9 mm	24-4652-D
24-4651-E	Fig. 4	11 mm	24-4652-E
24-4651-F	Fig. 5	12 mm	24-4652-F
24-4651-G	Fig. 6	14 mm	24-4652-G
24-4651-H	Fig. 7	15 mm	24-4652-H
24-4651-I	Fig. 8	16 mm	24-4652-I
24-4651-J	Fig. 9	19 mm	24-4652-J
24-4651-K	Fig. 10	20 mm	24-4652-K
24-4651-L	Fig. 11	21 mm	24-4652-L
24-4651-M	Fig. 12	23 mm	24-4652-M
24-4651-N	Fig. 13	25 mm	24-4652-N
24-4651-O	Fig. 14	30 mm	24-4652-O
24-4651-P	Fig. 15	35 mm	24-4652-P
24-4651-Q	Fig. 16	40 mm	24-4652-Q



Obstetrical Forceps



M.F.ELAHI MEDICAL CO
SERVING WORLDWIDE SURGICAL INSTRUMENTS



25-4700
Wrigley
23 cm
28 cm



25-4701
De-lee
30 cm



25-4702
De-lee
36 cm



25-4703
Simpson
23 cm str
23 cm cvd



25-4704
Simpson
23 cm
30 cm



25-4705
Simpson-braun
23 cm
30 cm



25-4706
Kielland
41 cm



25-4707
Piper
44 cm



25-4708
Elliot
32 cm, 38 cm



25-4709
Naegele
36 cm, 40 cm



25-4710
Kedar Nath Das
33 cm



25-4711
Boerma
33 cm



Obstetrical Forceps, Uterine Haemostasis
Forceps and Umbilical Cord Clamps



M.F.ELAHI MEDICAL CO
SERVING WORLDWIDE SURGICAL INSTRUMENTS



25-4712
Lafe-piper
30 cm



25-4713
Lafe Divergent Outlet
31 cm

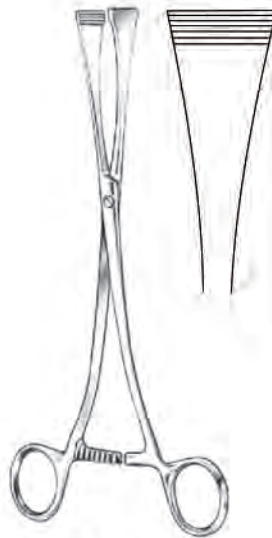

25-4714
Green-armytage
21 cm



25-4715
Green-armytage
19.5 cm



25-4716
Gauss
26 cm

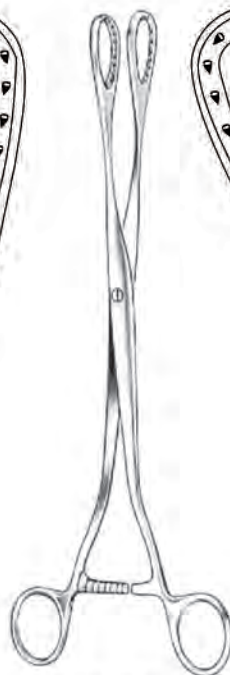

25-4717
Saenger
27 cm

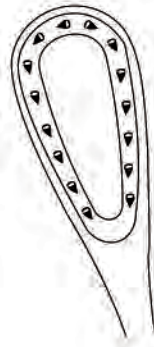

25-4718
Sellheim
28 cm



25-4719
Kane
8.5 cm



25-4720
Collin
9 cm





Placenta and Ovum forceps, Ovum Curettes, Abortion Scoops



25-4721
Heywood-smith
25 cm



25-4722
Corey
24 cm



25-4723
Willet
19 cm



25-4724-25-4726
Winter
28 cm



25-4724
Fig. 1



25-4725
Fig. 2



25-4726
Fig. 3



25-4727
Winter-nassauer
28 cm



25-4728
Spackmann
35 cm



25-4729
Spackmann
35 cm



25-4730
Leech-wilkinson
26.5 cm



25-4730
Ø 10 x 25mm
small

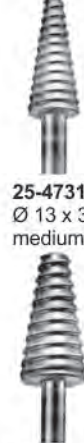

25-4731
Ø 13 x 30mm
medium



25-4732
Ø 16 x 30mm
large



toothed back

25-4733
14.5 mm

25-4734
18 mm

25-4735
21 mm

25-4733-25-4735
Cuzzi
30 cm, blunt



Ovum Currettes, Abortion Scoops, Aspirating Currettes, Pelvimeters



M.F. ELAHI MEDICAL CO
SERVING WORLDWIDE SURGICAL INSTRUMENTS

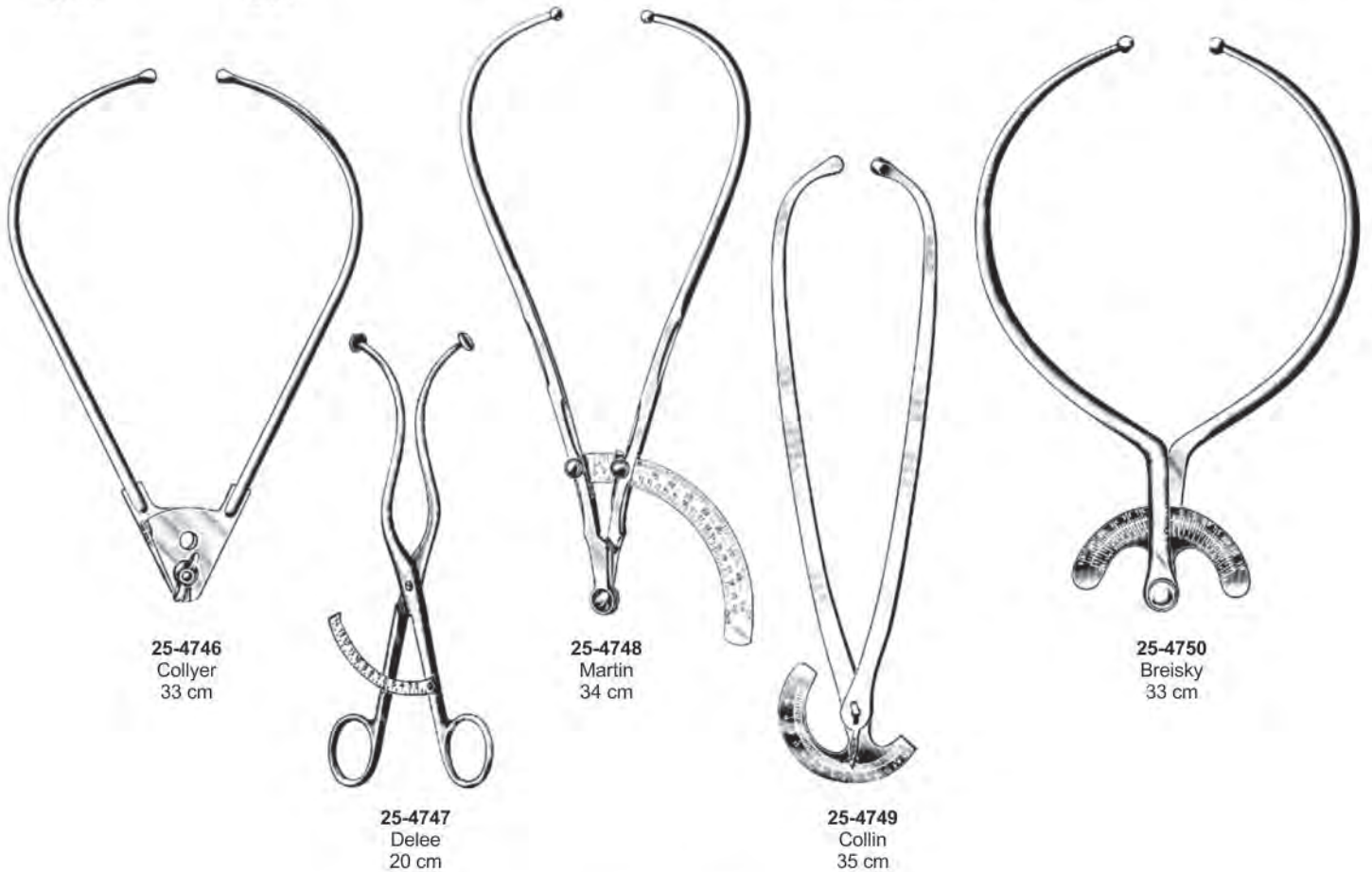

Goitre Enucleator, Goitre Grasping Forceps



M.F. ELAHI MEDICAL CO
SERVING WORLDWIDE SURGICAL INSTRUMENTS



26-4800
SCHOEMAKER
15 cm



26-4801
Kocher
15 cm

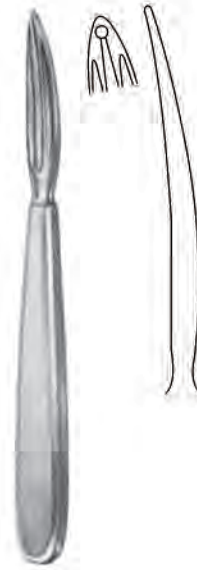

26-4802
Kocher
15 cm



26-4803
Kocher
18 cm



26-4804
Hofmeister
21 cm



26-4805
Lahey
15 cm



26-4806
Mastin
17 cm



Sterilizing Forceps



M.F. ELAHI MEDICAL CO
SERVING WORLDWIDE SURGICAL INSTRUMENTS



27-4900
Cheate
27 cm



27-4901
Cheate
26.5 cm



27-4902
Cheate
28 cm



27-4903
20 cm, 30 cm

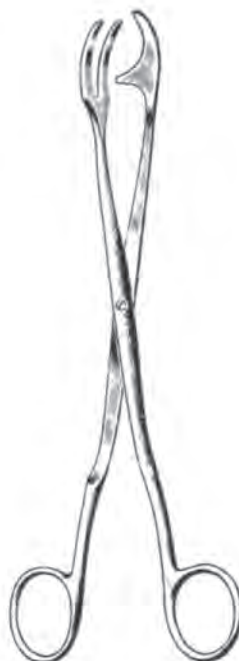

27-4904
Rogge
23 cm



27-4905
16 cm
27-4906
20 cm
27-4907
24 cm

27-4905-27-4907
Davis



Nail Scissors, Nail Nippers, Cuticle Scissors,
Nail Files



M.F. ELAHI MEDICAL CO
SERVING WORLDWIDE SURGICAL INSTRUMENTS



28-5000
10.5 cm
11.5 cm



28-5001
10.5 cm
11.5 cm



28-5002
10.5 cm



28-5003
11 cm



28-5004
14 cm



28-5005
14 cm
16 cm



28-5006
Turnbull
12 cm, 13 cm



28-5007
13 cm



28-5008
12 cm



28-5009
10 cm, 13 cm
15 cm



28-5010
11 cm, 13 cm



28-5011
10 cm



28-5012
11 cm



28-5013
16 cm



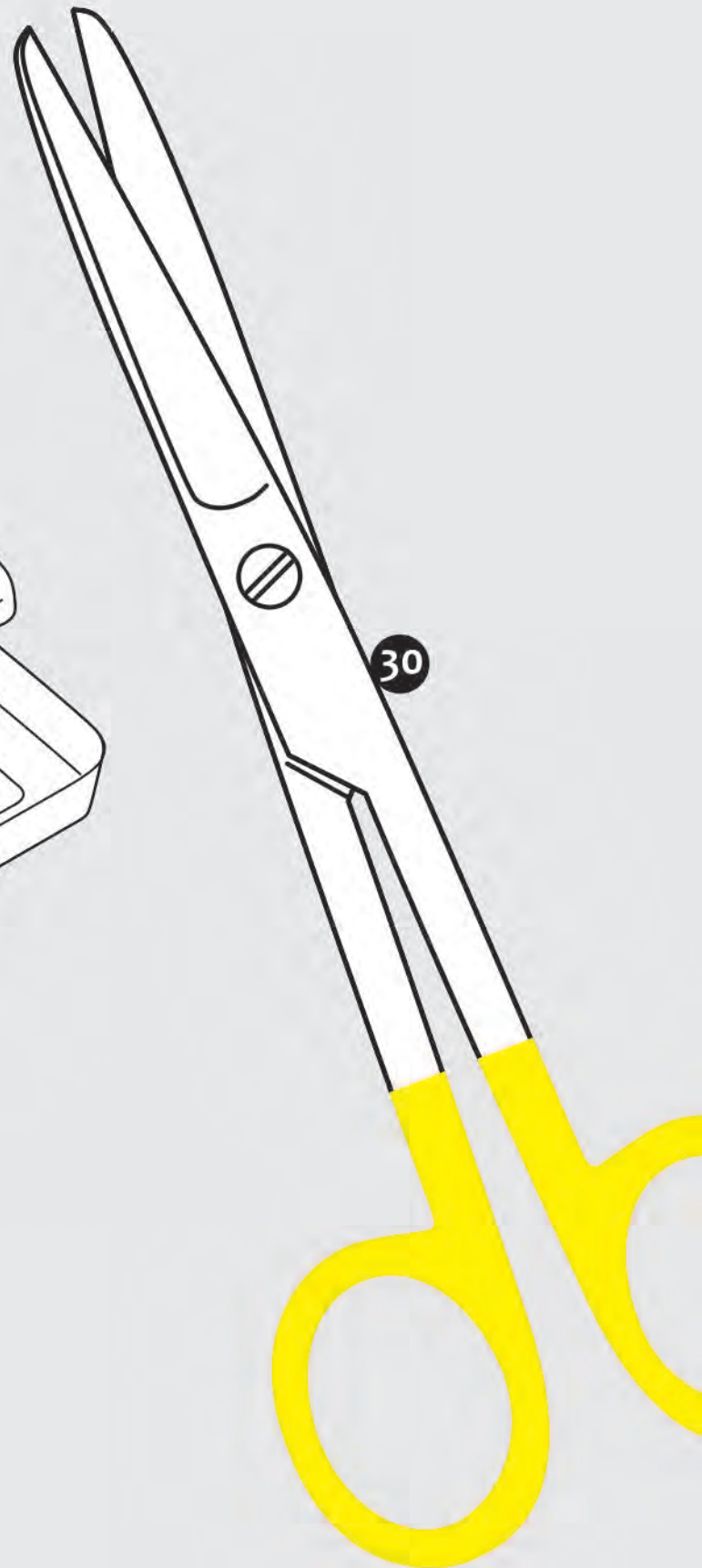
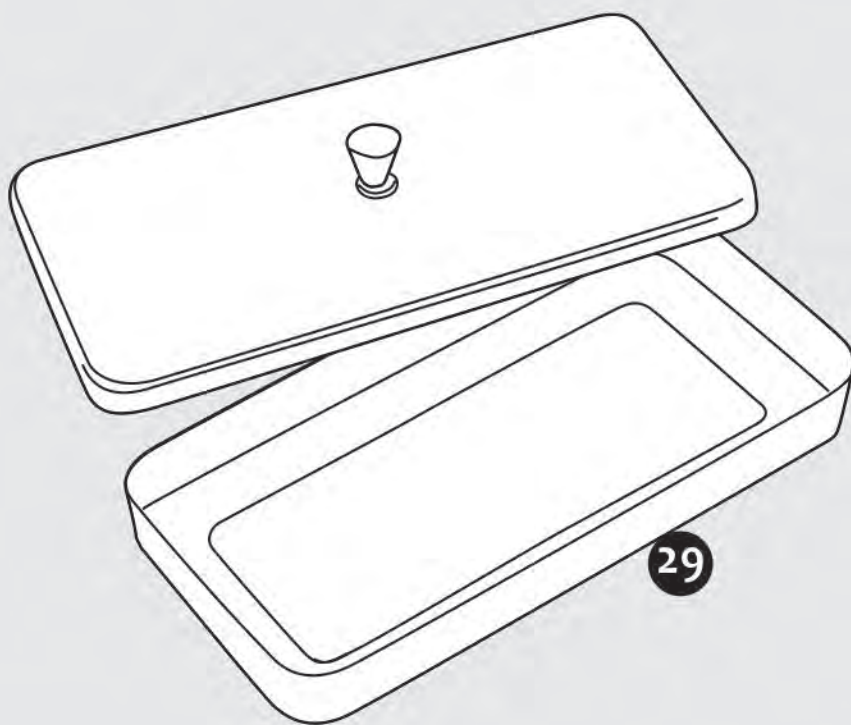

Section # 29-30

- 29 Hollowware
- 30 TC Instruments



Needle Case, Endodontic Box, Tube Rack, Cotton Holder, Jars, Jallipot, Bowls, Cups



29-5100
Needle Case Round with Cover
65x15mm



29-5101
Needle Case Round
80x20mm



29-5102
Needle Case Rectangle
80x20mm



29-5103
Endodontic Box
100x40x50mm



29-5104-29-5106
Tube Rack

29-5104
6.35x15.25x5cm for 12 tubes
29-5105
6.35x17.75x7.5cm for 27 tubes
29-5106
7.50x17.75x6.35cm for 36 tubes



29-5107
Sprit Lamp
Standard Size



29-5108
Sprit Lamp
Standard Size



29-5109-29-5111
Sputum Cup

29-5109
75x80mm
29-5110
100x50mm
29-5111
100x80mm



29-5112-29-5118
Dressing Jar

29-5112 80x60mm
29-5113 80x80mm
29-5114 100x100mm
29-5115 120x120mm
29-5116 150x150mm
29-5117 180x180mm
29-5118 200x200mm



29-5119-29-5125
Dressing Jar

29-5119 80x60mm
29-5120 80x80mm
29-5121 100x100mm
29-5122 120x120mm
29-5123 150x150mm
29-5124 180x180mm
29-5125 200x200mm



29-5126-29-5129
Fennle

29-5126
100mm Ø
29-5127
120mm Ø
29-5128
150mm Ø
29-5129
200mm Ø



29-5130
Cotton Holder



29-5131
Cotton Holder



29-5132-29-5140
Forceps Jar

29-5132
30x90mm
29-5133
50x125mm
29-5134
50x170mm
29-5135
50x200mm
29-5136
40x230mm
29-5137
70x110mm
29-5138
80x150mm
29-5139
100x200mm
29-5140
150x30mm





Bowls, Cups, Kedney Trays



29-5141-29-5156
Gallipot

- | | |
|----------------|----------------|
| 29-5141 | 29-5149 |
| 01 oz | 09 oz |
| 29-5142 | 29-5150 |
| 02 oz | 10 oz |
| 29-5143 | 29-5151 |
| 03 oz | 11 oz |
| 29-5144 | 29-5152 |
| 04 oz | 12 oz |
| 29-5145 | 29-5153 |
| 05 oz | 13 oz |
| 29-5146 | 29-5154 |
| 06 oz | 14 oz |
| 29-5147 | 29-5155 |
| 07 oz | 15 oz |
| 29-5148 | 29-5156 |
| 08 oz | 16 oz |



29-5157-29-5159
Spong Bowl

- | |
|----------------|
| 29-5157 |
| 12 cm |
| 29-5158 |
| 15 cm |
| 29-5159 |
| 20 cm |



29-5160-29-5162
Medicine Cup

- | |
|----------------|
| 29-5160 |
| 50ml |
| 29-5161 |
| 60ml |
| 29-5162 |
| 70ml |



29-5163-29-5176
Lotion Bowl without spout

- | | |
|----------------|----------------|
| 29-5163 | 29-5170 |
| 40x19mm | 150x65mm |
| 29-5164 | 29-5171 |
| 50x25mm | 180x85mm |
| 29-5165 | 29-5172 |
| 60x30mm | 200x100mm |
| 29-5166 | 29-5173 |
| 80x40mm | 250x120mm |
| 29-5167 | 29-5174 |
| 100x50mm | 300mm |
| 29-5168 | 29-5175 |
| 120x60mm | 350mm |
| 29-5169 | 29-5176 |
| 140x60mm | 400mm |



29-5176-29-5180
Wash Basin

- | |
|----------------|
| 29-5176 |
| 300x80mm |
| 29-5177 |
| 320x85mm |
| 29-5178 |
| 330x90mm |
| 29-5179 |
| 350x110mm |
| 29-5180 |
| 400x115mm |



29-5181
Kick Bucket with Trolley
390x280x180mm



29-5182-29-5184
Kidney Tray Shallow

- | |
|----------------|
| 29-5182 |
| 17cm |
| 29-5183 |
| 22cm |
| 29-5184 |
| 24 cm |



29-5185-29-5191
Kidney Tray

- | | |
|----------------|----------------|
| 29-5185 | 29-5189 |
| 12 cm | 25 cm |
| 29-5186 | 29-5190 |
| 15 cm | 28 cm |
| 29-5187 | 29-5191 |
| 18 cm | 30 cm |
| 29-5188 | |
| 20 cm | |



29-5192
Kidney Tray (with cover)

- | |
|----------------|
| 29-5192 |
| 12 cm |
| 29-5193 |
| 15 cm |
| 29-5194 |
| 18 cm |
| 29-5195 |
| 20 cm |



Wire Mesh Trays, Instruments Trays



29-5196-29-5202
Wire Mesh Tray

- | | |
|-------------------------------|--------------------------------|
| 29-5196
240x250x5mm | 29-5200
480x250x7mm |
| 29-5197
480x250x5mm | 29-5201
240x250x10mm |
| 29-5198
550x250x5mm | 29-5202
480x250x10mm |
| 29-5199
240x250x7mm | |



29-5203-29-5209
Wire Mesh Tray with Lid

- | | |
|-------------------------------|--------------------------------|
| 29-5203
240x250x5mm | 29-5207
480x250x7mm |
| 29-5204
480x250x5mm | 29-5208
240x250x10mm |
| 29-5205
550x250x5mm | 29-5209
480x250x10mm |
| 29-5206
240x250x7mm | |



29-5210-29-5214
Perforated Tray

- | | |
|--------------------------------|--------------------------------|
| 29-5210
200x100x40mm | 29-5213
350x170x50mm |
| 29-5211
250x120x50mm | 29-5214
400x200x50mm |
| 29-5212
300x150x50mm | |



29-5215-29-5222
Instruments Tray without Lid

- | | |
|--------------------------------|--------------------------------|
| 29-5215
100x150x25mm | 29-5219
300x350x50mm |
| 29-5216
150x200x40mm | 29-5220
150x300x50mm |
| 29-5217
200x250x45mm | 29-5221
200x300x50mm |
| 29-5218
250x300x50mm | 29-5222
230x150x50mm |



29-5223-29-5230
Instruments Tray with Lid

- | | |
|--------------------------------|--------------------------------|
| 29-5223
100x150x25mm | 29-5227
300x350x50mm |
| 29-5224
150x200x40mm | 29-5228
150x300x50mm |
| 29-5225
200x250x45mm | 29-5229
200x300x50mm |
| 29-5226
250x300x50mm | 29-5230
230x150x50mm |



29-5231
Burr Tray
190x100x20mm



29-5232-29-5234
Catheter Tray with Lid

- | |
|--------------------------------|
| 29-5232
300x80x40mm |
| 29-5233
350x90x45mm |
| 29-5234
400x100x50mm |



29-5235-29-5242
Instruments Box
with Hooks

- | | |
|--------------------------------|---------------------------------|
| 29-5235
170x70x30mm | 29-5239
250x125x50mm |
| 29-5236
180x80x40mm | 29-5240
300x150x50mm |
| 29-5237
200x100x40mm | 29-5241
350x170x50mm |
| 29-5238
230x120x50mm | 29-5242
500x200x120mm |



29-5243-29-5250
Instruments Box

- | | |
|--------------------------------|---------------------------------|
| 29-5243
170x70x30mm | 29-5247
250x125x50mm |
| 29-5244
180x80x40mm | 29-5248
300x150x50mm |
| 29-5245
200x100x40mm | 29-5249
350x170x50mm |
| 29-5246
230x120x50mm | 29-5250
500x200x120mm |



29-5251
Scaler Tray with cover
200x100x16mm

Instruments Box, Sterilization Box



M.F. ELAHI MEDICAL CO
SERVING WORLDWIDE SURGICAL INSTRUMENTS



29-5252-29-5254
Instruments Box Perforated

- | | |
|--------------------------------|--------------------------------|
| 29-5252
200x100x40mm | 29-5254
300x150x40mm |
| 29-5253
250x150x40mm | |



29-5255-29-5260
Electric Sterilizer

- | | |
|---------------------------------|---------------------------------|
| 29-5255
200x100x120mm | 29-5258
350x170x170mm |
| 29-5256
250x120x140mm | 29-5259
400x200x180mm |
| 29-5257
300x150x150mm | 29-5260
450x230x190mm |



29-5261-29-5265
Non Electric Sterilizer

- | | |
|---------------------------------|---------------------------------|
| 29-5261
200x100x65mm | 29-5264
350x170x65mm |
| 29-5262
250x125x65mm | 29-5265
400x200x100mm |
| 29-5263
300x150x100mm | |



29-5266-29-5269
Electric Sterilizer
280x125x65mm

- | |
|--------------------------------|
| 29-5266
170x70x30mm |
| 29-5267
180x80x40mm |
| 29-5268
200x100x40mm |
| 29-5269
230x120x50mm |



29-5270-29-5287
Sterilizer Drum

- | | |
|-----------------------------|-----------------------------|
| 29-5270
125x80mm | 29-5279
240x240mm |
| 29-5271
125x120mm | 29-5280
290x140mm |
| 29-5272
150x100mm | 29-5281
290x240mm |
| 29-5273
150x150mm | 29-5282
290x290mm |
| 29-5274
180x180mm | 29-5283
340x160mm |
| 29-5275
190x140mm | 29-5284
340x340mm |
| 29-5276
190x190mm | 29-5285
390x150mm |
| 29-5277
200x200mm | 29-5286
390x200mm |
| 29-5278
240x120mm | 29-5287
390x290mm |



29-5288
Bedpan Hand Made
Standard



29-5289-29-5290
Bedpan Hand Made
29-5289 Adult
29-5290 Child



29-5291
Bedpan Hand Made
Standard



Urinal, Bedpan, Bucket, Jug



29-5292-29-5293
Bedpan Sleeper Type

29-5292 **29-5293**
Adult Child



29-5294
Bedpan Chamber Port
Standard



29-5295-29-5296
Bedpan Simple
pressed body with handle
29-5295 **29-5296**
Adult Child



29-5297
Urinal Female
Standard

29-5298
Urinal Male Vertical
Standard

29-5299
Urinal Male
Standard



29-5300
Bedpan perfection type seamless
350x300mm



29-5301
Bedpan perfection type
370x290mm
29-5302
320x240mm



29-5303-29-5305
Measuring Jug
29-5303 **29-5304**
0.5 Ltr 1.5 Ltr
29-5304 **29-5305**
1.0 Ltr 2.0 Ltr



29-5306-29-5308
Pail/Bucket with Lid
29-5306 **29-5308**
06 Ltr 15 Ltr
29-5307
10 Ltr



29-5309-29-5311
Douch Can/Irrigator
29-5309 **29-5310**
1.0 Ltr 2.0 Ltr
29-5311
1.5 Ltr



Nasal Scissors, Aquila-Scissors





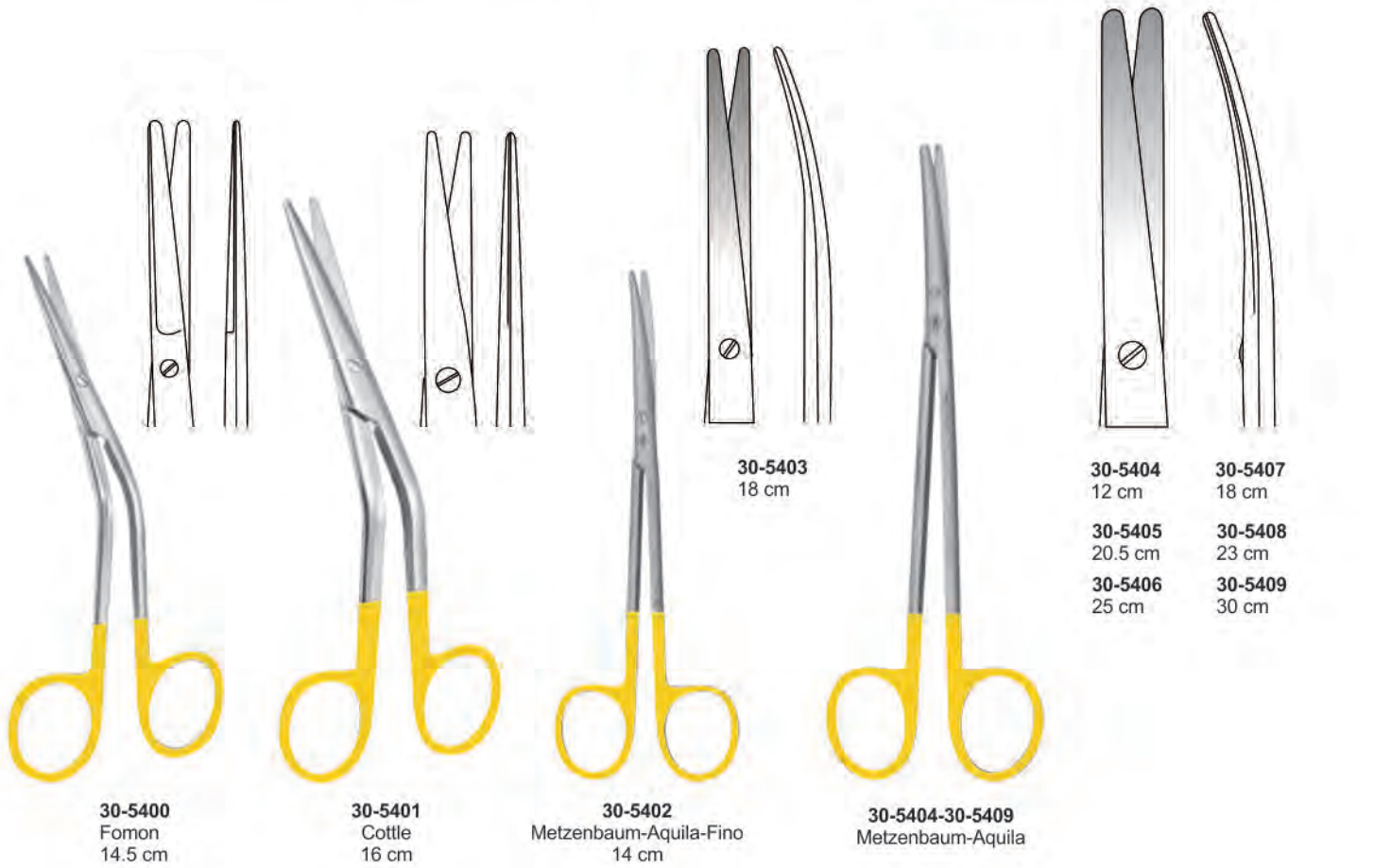







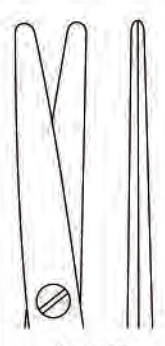





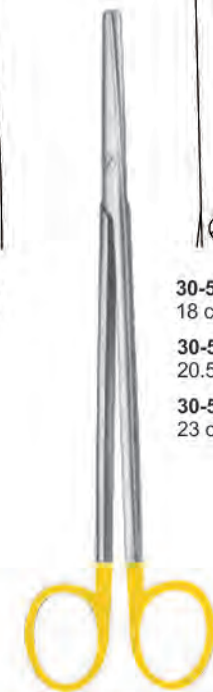
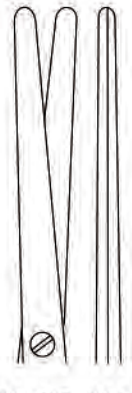





M.F. ELAHI MEDICAL CO
SERVING WORLDWIDE SURGICAL INSTRUMENTS



Dissecting Scissors

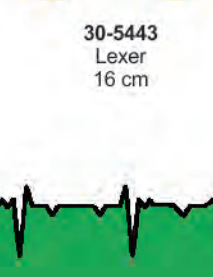

M.F. ELAHI MEDICAL CO
SERVING WORLDWIDE SURGICAL INSTRUMENTS

 30-5418 Mayo-Stille 14.5 cm	 30-5419 17 cm	 30-5420 Mayo-Stille 14.5 cm	 30-5421 17 cm	 30-5422 Metzenbaum 11.5 cm	 30-5423 14.5 cm	 30-5424 Metzenbaum 11.5 cm	 30-5425 14.5 cm	 30-5426-30-5431 Metzenbaum	 30-5426 18 cm	 30-5429 26 cm
									30-5427 20.5 cm	30-5430 28.5 cm
									30-5428 23 cm	30-5431 31 cm
 30-5432-30-5437 Metzenbaum	 30-5432 18 cm	 30-5435 26 cm	 30-5433 20.5 cm	 30-5436 28.5 cm	 30-5434 23 cm	 30-5437 31 cm	 30-5438-30-5440 Metzenbaum-Thorek	 30-5438 20 cm	 30-5439 23 cm	 30-5440 28 cm
					 30-5441-30-5442 Joseph	 30-5441 14.5 cm	 30-5442 14.5 cm	 30-5444 21 cm		
										 30-5443 Lexer 16 cm



Dissecting Scissors, Operating Scissors,
Delicate Dissecting Scissors

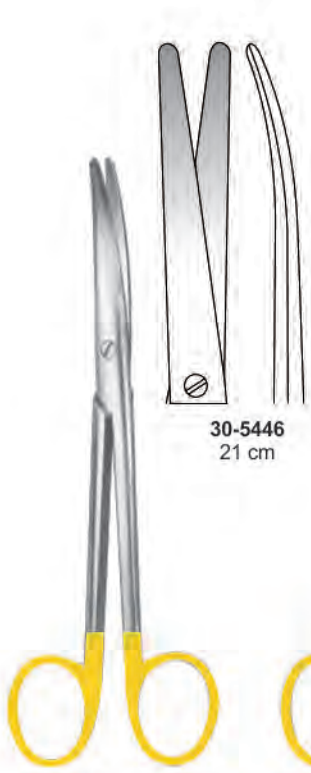
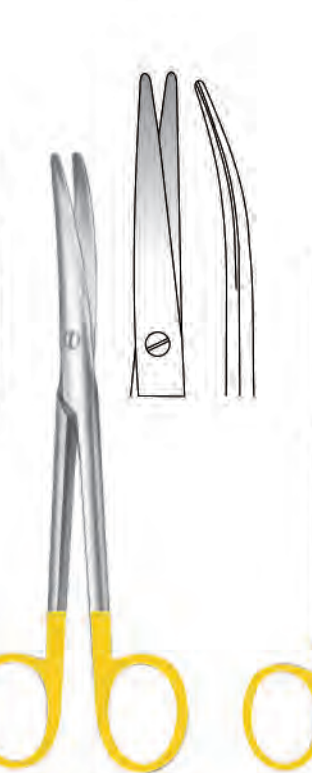
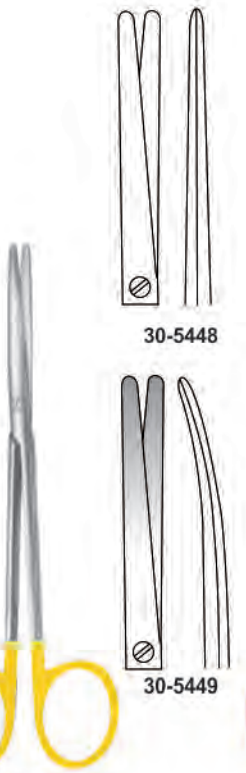
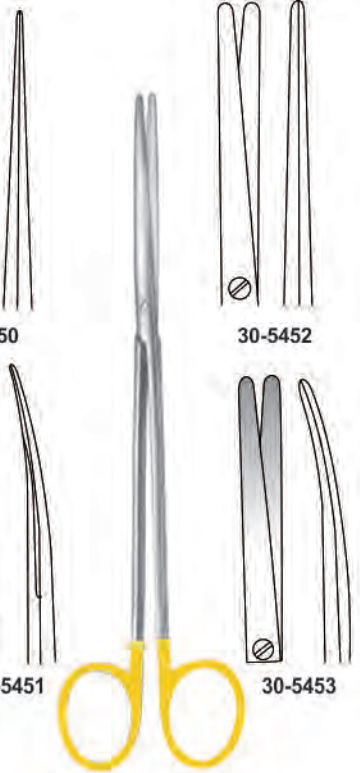
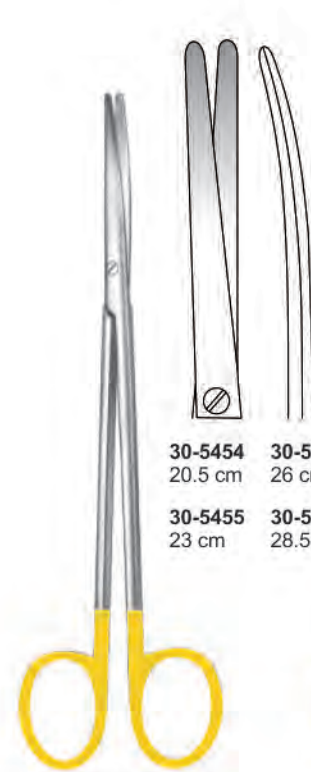
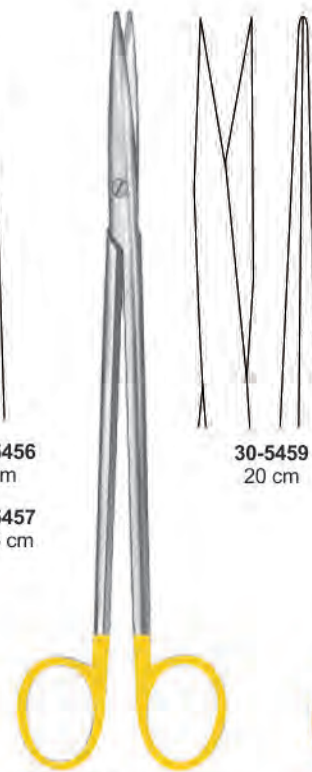
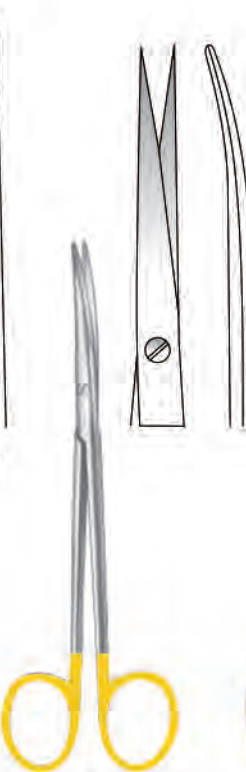
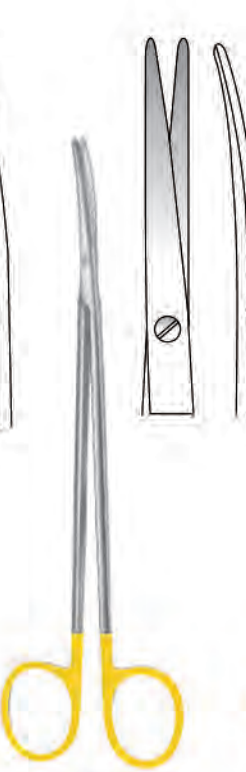

 <p>30-5446 21 cm</p>		 <p>30-5448 30-5449</p>	 <p>30-5450 30-5451</p>	 <p>30-5452 30-5453</p>
<p>30-5445 Lexer 16 cm</p>	<p>30-5447 Mayo-Lexer 16 cm</p>	<p>30-5448-30-5449 Metzenbaum-Fino 14.5 cm</p>	<p>30-5450-30-5451 Metzenbaum-Fino 14.5 cm</p>	<p>30-5452-30-5453 Metzenbaum-Fino 18 cm</p>
 <p>30-5454 20.5 cm 30-5455 23 cm 30-5456 26 cm 30-5457 28.5 cm</p>		 <p>30-5459 20 cm</p>		 <p>30-5463 23 cm</p>
<p>30-5454-30-5457 Metzenbaum-Fino</p>	<p>30-5458 Metzenbaum-Fino 18 cm</p>	<p>30-5460 Metzenbaum-Lahey 14.5 cm</p>	<p>30-5461 Toennis-Adson 17.5 cm</p>	<p>30-5462 Metzenbaum-Fino 20.5 cm</p>



Delicate Dissecting Scissors, Face-lift Scissors, Aquila Scissors, Uterine Scissors

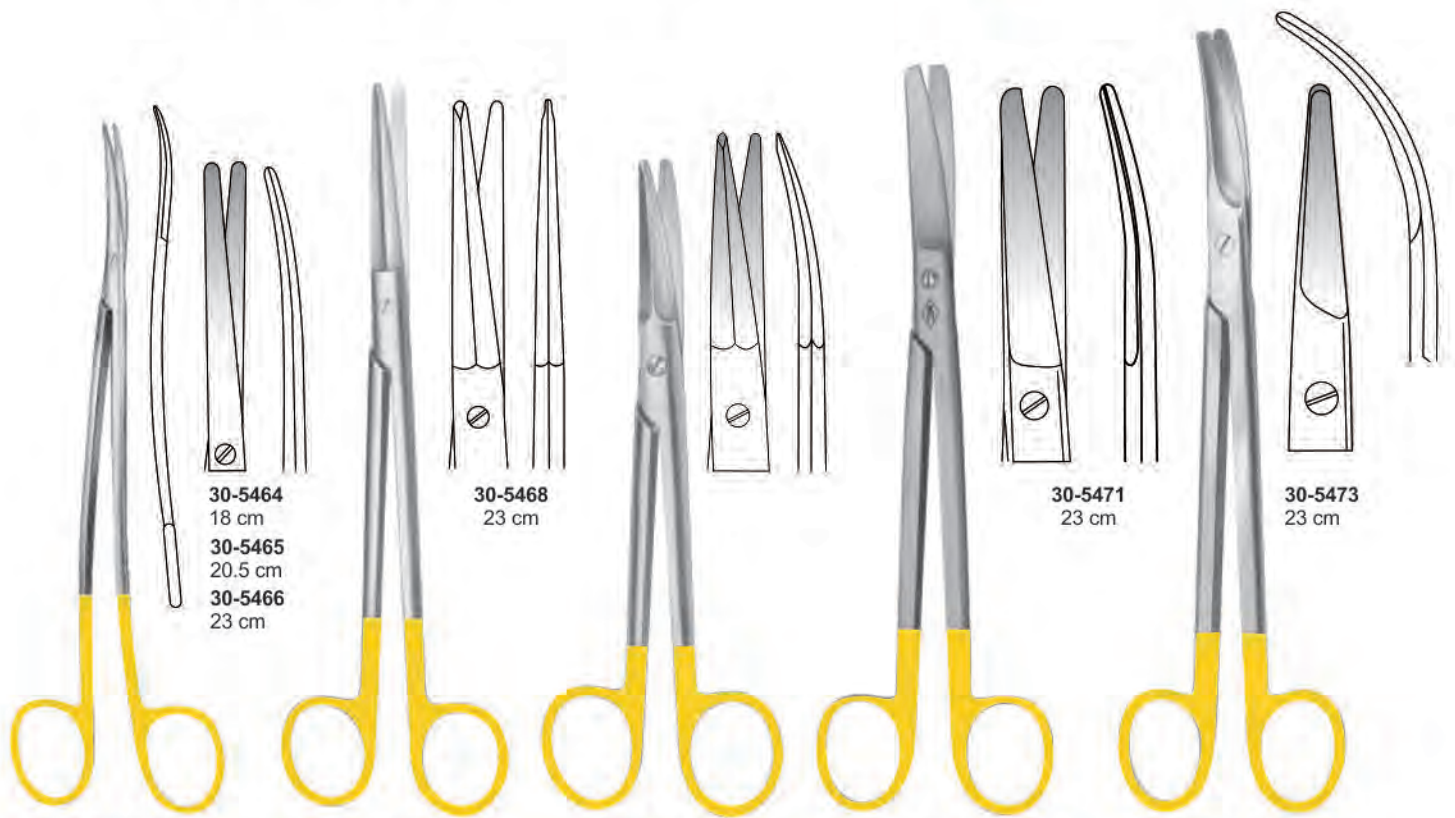

30-5464-30-5466
Metzenbaum-Fino

30-5467
Gorney
20 cm

30-5469
Rees
17 cm

30-5470
Sims-Aquila
20 cm

30-5472
22 cm

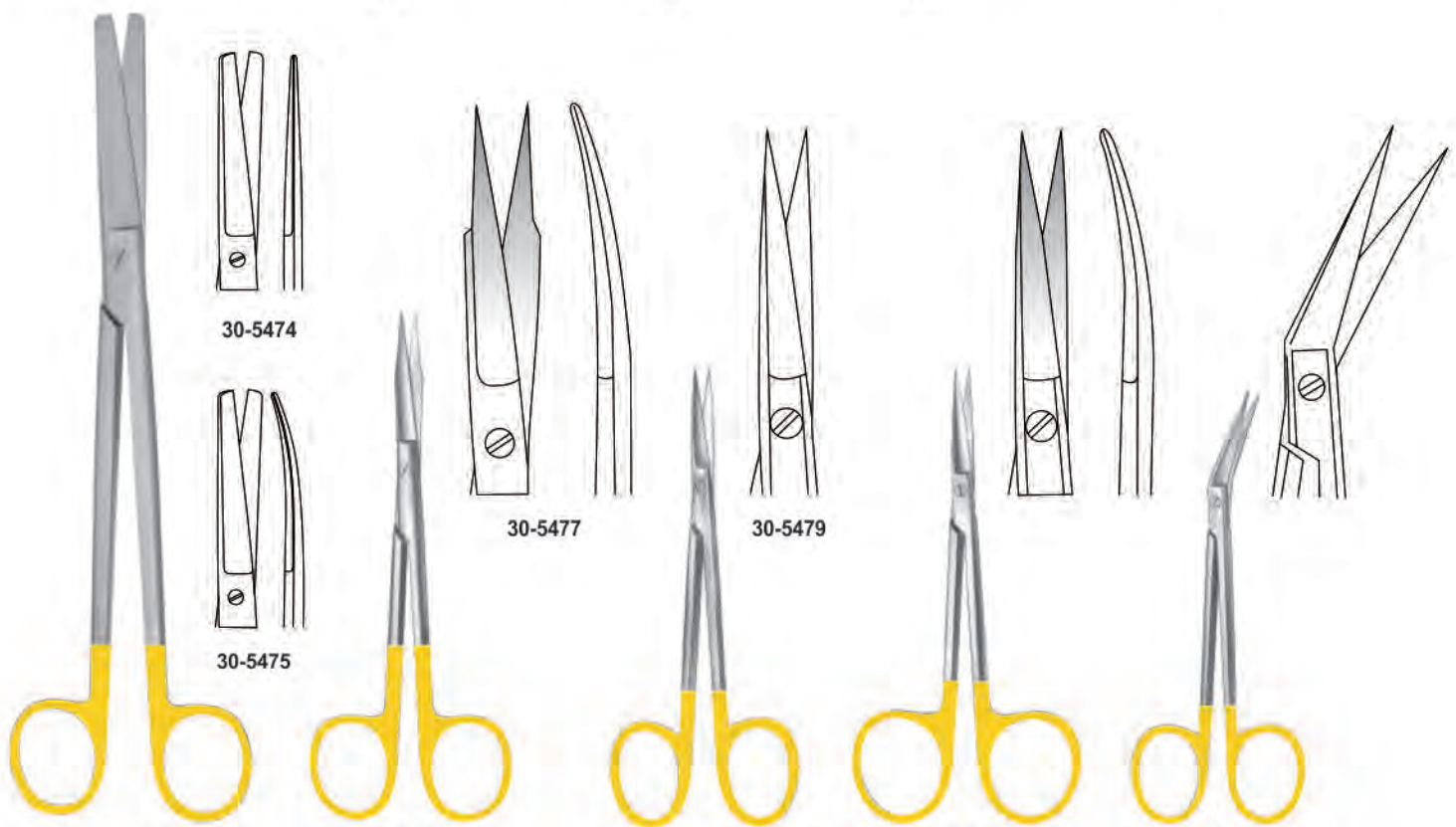

30-5474-30-5475
Sims
23 cm

30-5476
Goldmann-Fox
13 cm

30-5478
11.5 cm

30-5480
11.5 cm

30-5481
11 cm



Ligature Scissors, Iris Scissors, Angled Scissors



M.F.ELAHI MEDICAL CO
SERVING WORLDWIDE SURGICAL INSTRUMENTS



30-5482
19 cm

30-5485
19 cm

30-5482-30-5487
De Bakey

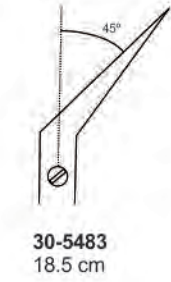

30-5483
18.5 cm

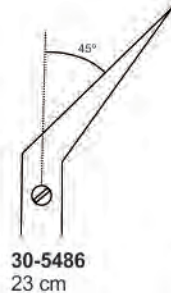

30-5486
23 cm

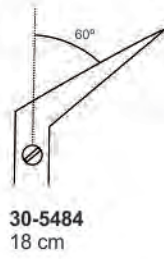

30-5484
18 cm



30-5487
22 cm

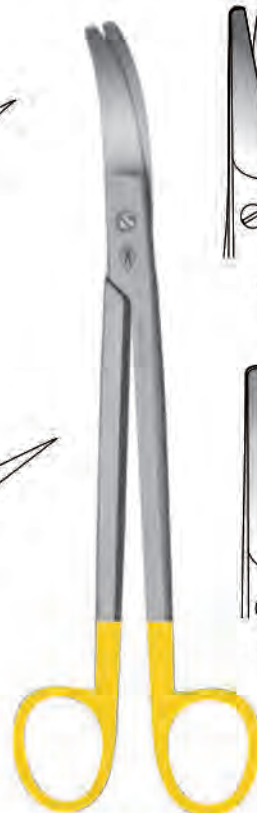

30-5488
22 cm

30-5489
23 cm

30-5488-30-5489

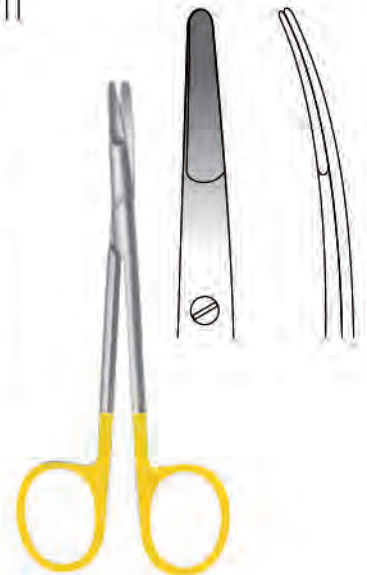

30-5490
Ragnell
12.5 cm

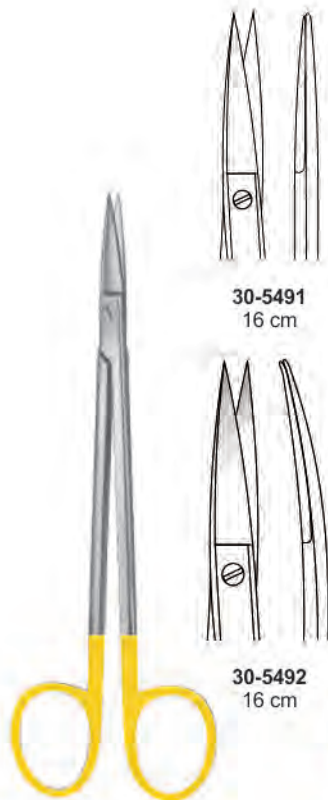

30-5491
16 cm

30-5492
16 cm

30-5491-30-5492
Kelly



30-5493
Dean
17.5 cm



30-5494
Locklin
16 cm



30-5495
Locklin
16 cm

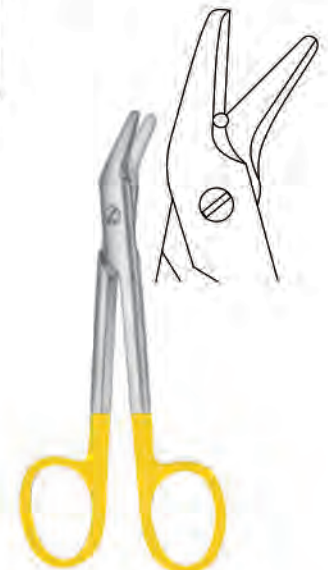

30-5496
Universal
12.5 cm



Tissue Forceps, Dissecting Forceps



30-5497
Bonney
17.5 cm



30-5498
Gerald
17.5 cm



30-5499
Gillies
15.5 cm



30-5500
McIndoe
15 cm



30-5501
Cushing



30-5502
Bonney
17.5 cm



30-5503
Cushing-Taylor
18.5 cm



30-5504-30-5509
De Bakey

- 30-5504 16 cm
- 30-5505 20 cm
- 30-5506 25 cm
- 30-5507 16 cm
- 30-5508 20 cm
- 30-5509 24.5 cm



30-5510-30-5513
Semken



30-5514-30-5518
Oehler



30-5519-30-5523
Potts-Smith



30-5524
Adson-Brown
12 cm



30-5525
Adson
12 cm



30-5527-30-5530
Adson

30-5510 15.5 cm

30-5511 15.5 cm

30-5512 15.5 cm

30-5513 15.5 cm

30-5514 14.5 cm
30-5515 16 cm
30-5516 18 cm
30-5517 20 cm
30-5518 25 cm

30-5519 16 cm
30-5520 18.5 cm
30-5521 20 cm
30-5522 23 cm
30-5523 25 cm

30-5526 15 cm

30-5527 12 cm
30-5529 15 cm

30-5528 12 cm
30-5530 15 cm



Micro Needle Holders



M.F. ELAHI MEDICAL CO
SERVING WORLDWIDE SURGICAL INSTRUMENTS

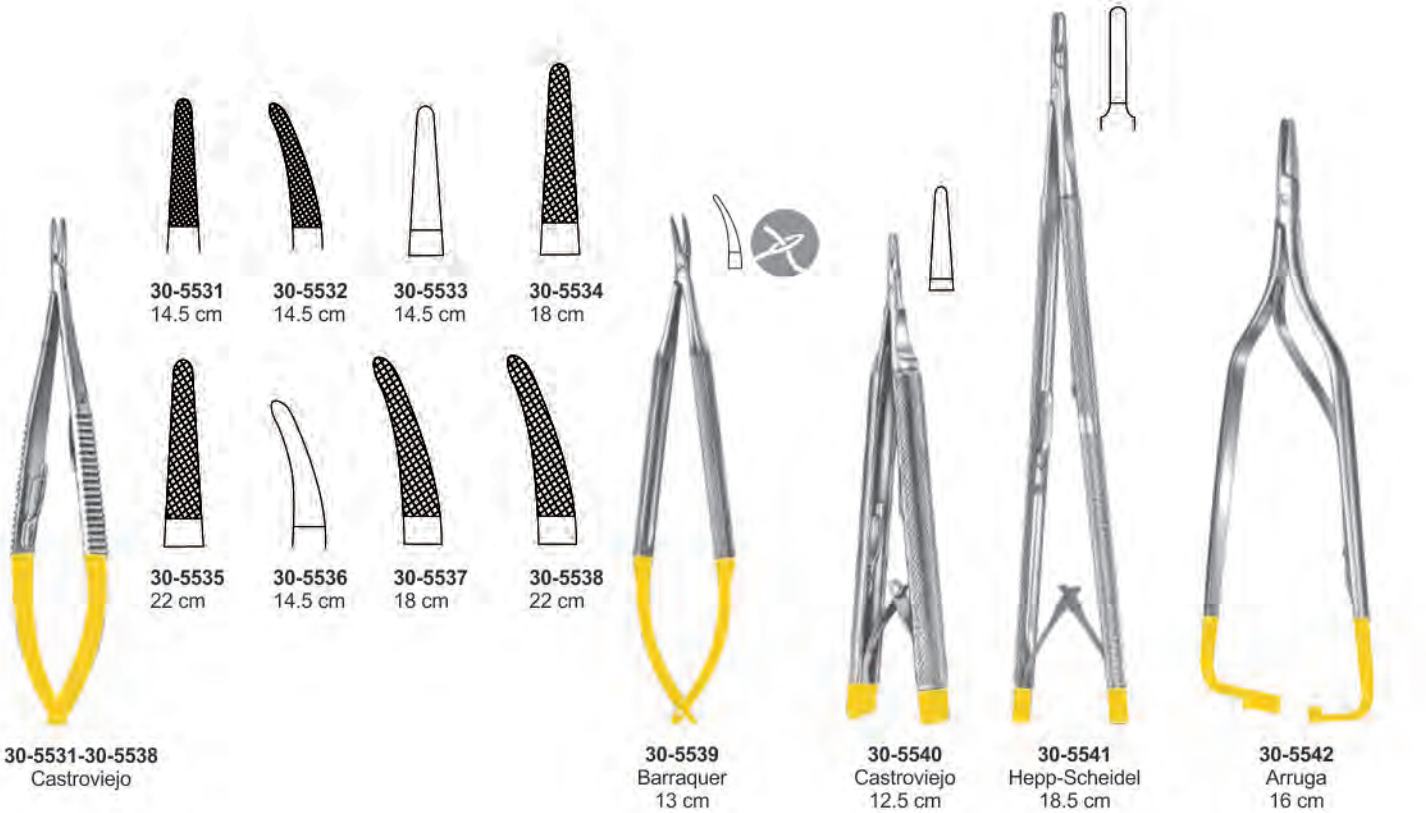

Micro Needle Holders, Needle Holders



M.F. ELAHI MEDICAL CO
SERVING WORLDWIDE SURGICAL INSTRUMENTS

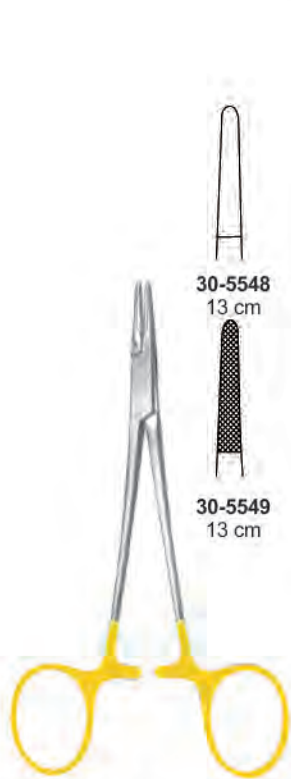

30-5548-30-5549
Halsey



30-5550
Crile-Wood
15 cm



30-5551
Crile-Wood
20 cm



30-5552-30-5554
Sarot



30-5555-30-5557
Heaney

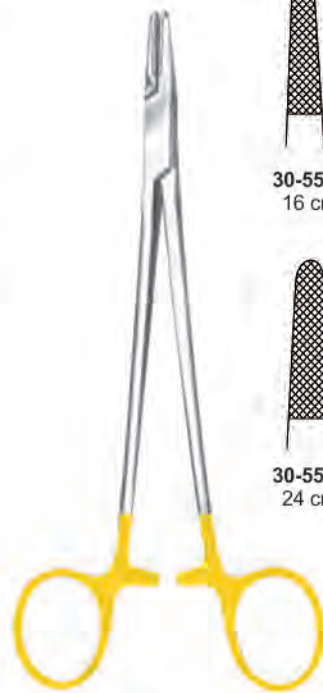

30-5558-30-5563
Mayo-Hegar



30-5558
16 cm



30-5559
20 cm



30-5560
20 cm



30-5561
24 cm



30-5562
26 cm



30-5563
30 cm

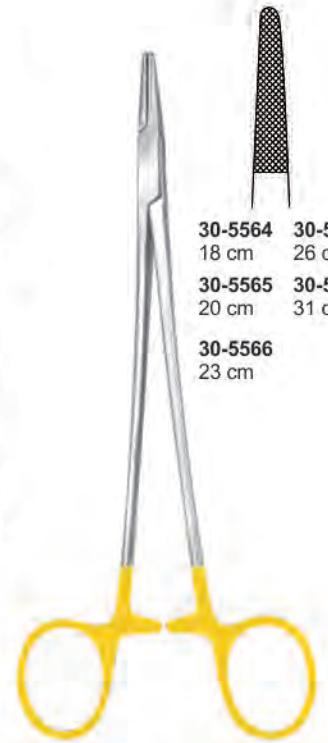

30-5564-30-5568
De Bakay

30-5564 18 cm 30-5567 26 cm

30-5565 20 cm 30-5568 31 cm

30-5566 23 cm



Needle Holders



M.F. ELAHI MEDICAL CO
SERVING WORLDWIDE SURGICAL INSTRUMENTS

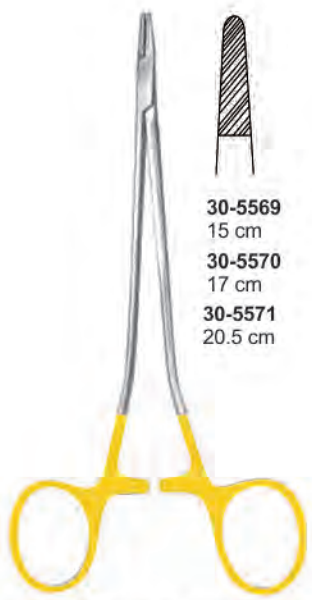

30-5569
15 cm
30-5570
17 cm
30-5571
20.5 cm

30-5569-30-5571
Martin



30-5572
27 cm

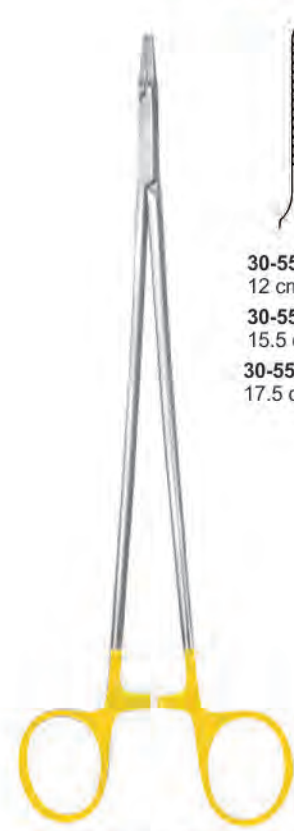

30-5573 30-5576
12 cm 20 cm
30-5574 30-5577
15.5 cm 22.5 cm
30-5575 30-5578
17.5 cm 26 cm

30-5573-30-5578
Ryder-Vascular



30-5579
27 cm



30-5580 30-5582
14 cm 20.5 cm
30-5581 30-5583
18.5 cm 23 cm

30-5580-30-5583
Hegar-Vascular

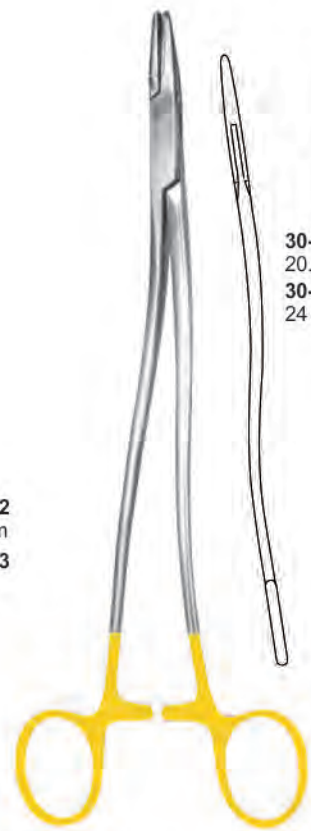

30-5584 30-5586
20.5 cm 26 cm
30-5585 30-5587
24 cm 29 cm

30-5584-30-5587



30-5589
24 cm

30-5588
Hegar
20 cm



30-5590

30-5590
Masson
26.5 cm



Needle Holders



M.F. ELAHI MEDICAL CO
SERVING WORLDWIDE SURGICAL INSTRUMENTS



30-5591	30-5594
13 cm	20 cm
30-5592	30-5595
15 cm	23 cm
30-5593	30-5596
18 cm	26 cm

30-5591-30-5596
Ryder



30-5597 30-5598

30-5597-30-5598
Stratte
23 cm



30-5599	30-5600
14 cm	20 cm
30-5601	30-5602
17.5 cm	23 cm

30-5599-30-5602
Microvascular

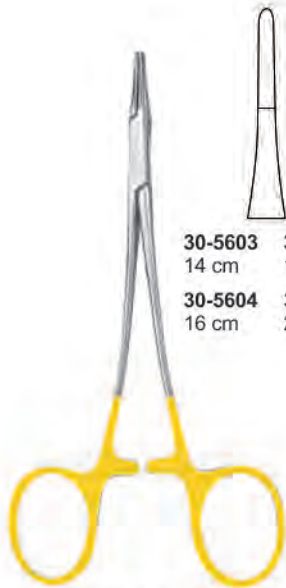

30-5603	30-5605
14 cm	17.5 cm
30-5604	30-5606
16 cm	20 cm

30-5603-30-5606
Martini

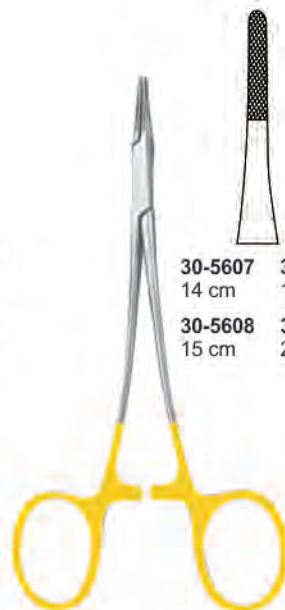

30-5607	30-5609
14 cm	17.5 cm
30-5608	30-5610
15 cm	20 cm

30-5607-30-5610
Martini

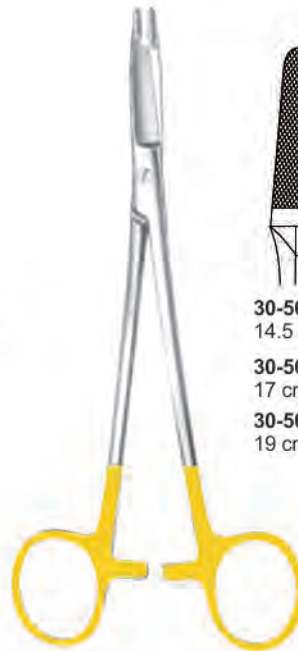

30-5611
14.5 cm
30-5612
17 cm
30-5613
19 cm

30-5611-30-5613
Olsen Hegar

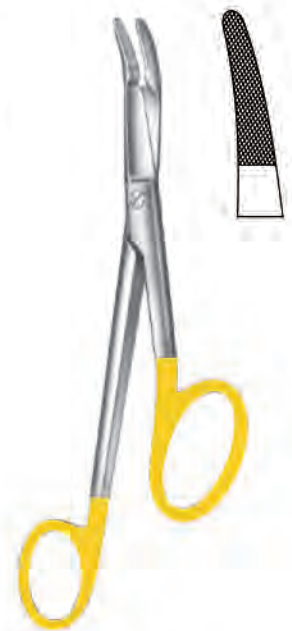

30-5614
Gillies
16 cm



Needle Holders



M.F. ELAHI MEDICAL CO
SERVING WORLDWIDE SURGICAL INSTRUMENTS

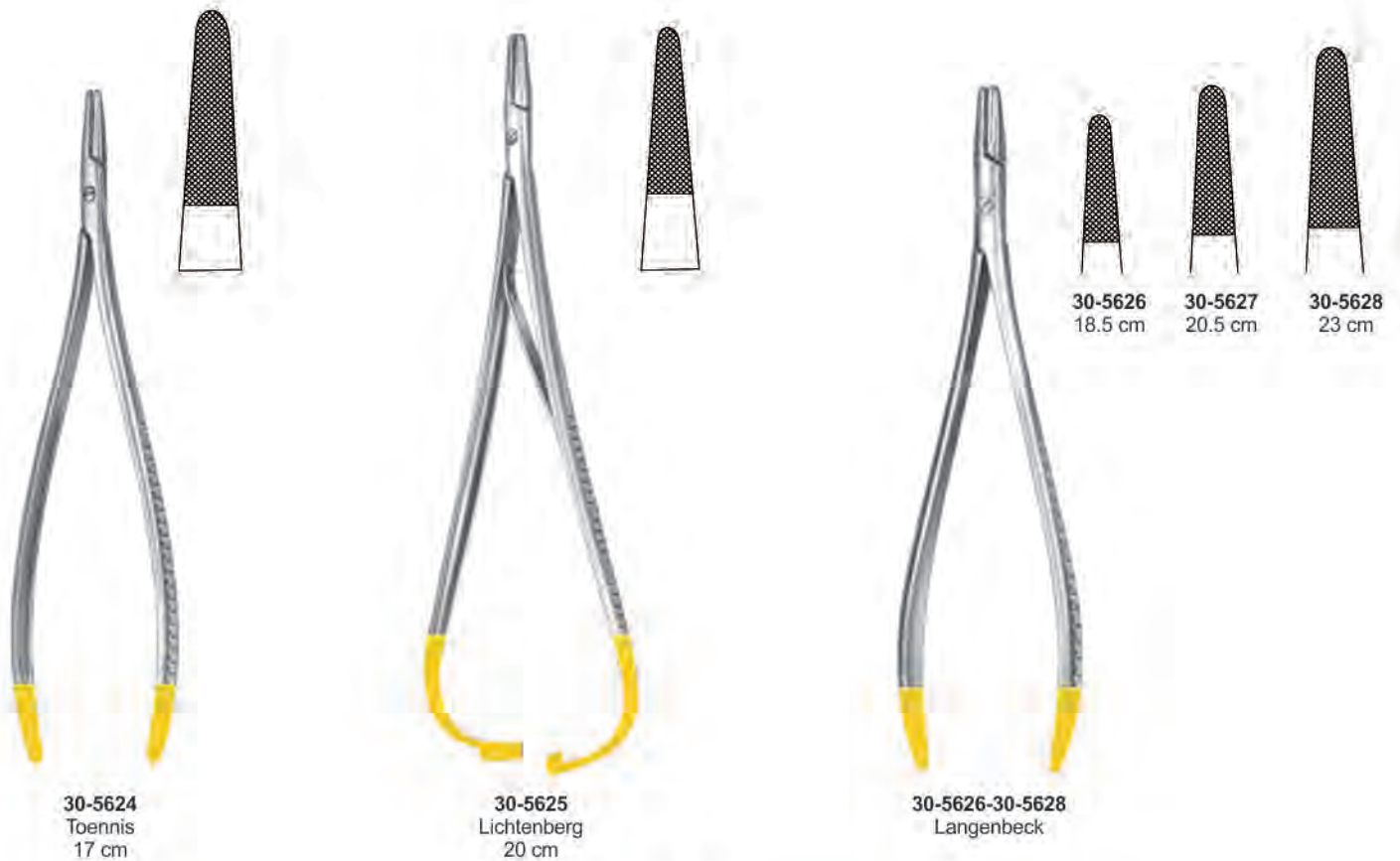
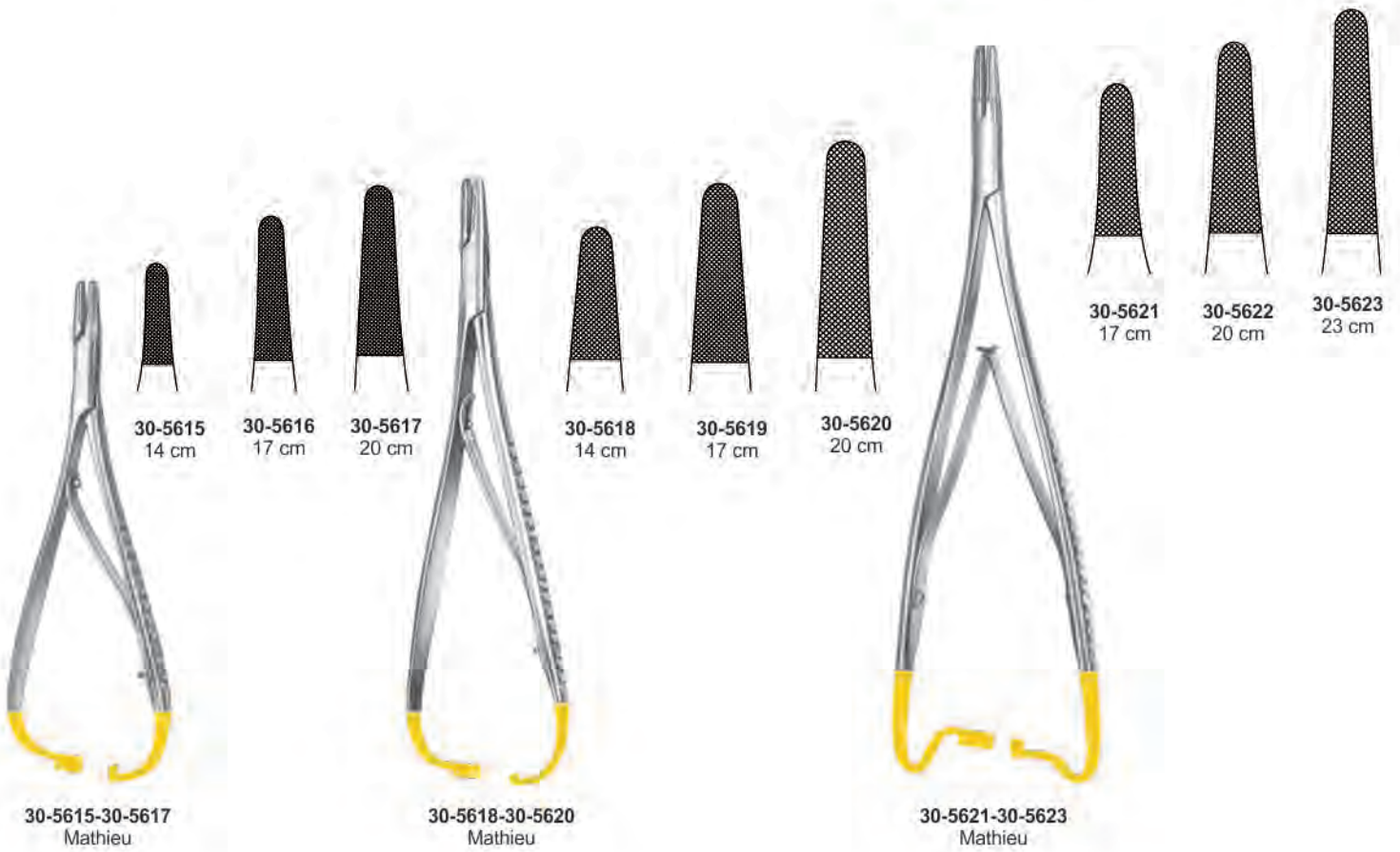



Flat Nose Wire Holding Forceps and Pliers



30-5629
15 cm

30-5630
15 cm

30-5629-30-5630
15 cm

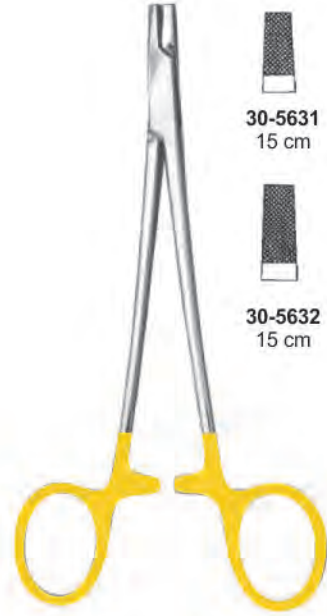

30-5631
15 cm

30-5632
15 cm

30-5631-30-5632
15 cm



30-5633
15 cm



30-5634
20 cm



30-5635
17 cm



30-5636
18.5 cm



30-5637-30-5639
18 cm

30-5637
18.5 cm

30-5638
18.5 cm

30-5639
18.5 cm



Wire Cutting Pliers



M.F. ELAHI MEDICAL CO
SERVING WORLDWIDE SURGICAL INSTRUMENTS



For Hard Wire
up to 1.0 mm Ø
For Soft Wire
up to 1.6 mm Ø

30-5640
18.5 cm



For Hard Wire
up to 1.6 mm Ø
For Soft Wire
up to 2.0 mm Ø

30-5641
REILL
16 cm



For Hard Wire
up to 2.0 mm Ø
For Soft Wire
up to 2.0 mm Ø

30-5642
22 cm



For Hard Wire
up to 3.0 mm Ø
For Soft Wire
up to 3.5 mm Ø

30-5643
23 cm



30-5644
25 cm

For Hard Wire
up to 3.0 mm Ø
For Soft Wire
up to 3.5 mm Ø



For Hard Wire
up to 3.0 mm Ø
For Soft Wire
up to 3.5 mm Ø

30-5645
22 cm



For Hard Wire
up to 2.5 mm Ø
For Soft Wire
up to 3.0 mm Ø

30-5646
23.5 cm





Wire Cutting Pliers



30-5647
Angle
12 cm



30-5648
14 cm



30-5649
32 cm



30-5650
14 cm
30-5651
18 cm



30-5652
18 cm



For Soft Wire
up to 2.0 mm Ø



For Soft Wire
up to 1.5 mm Ø



30-5653 - 30cm
for wire up to 4.0 mm Ø
30-5654 - 47cm
for wire up to 5.0 mm Ø
30-5655 - 56cm
for wire up to 6.0 mm Ø



30-5656 - 30cm
for wire up to 4.0 mm Ø
30-5657 - 47cm
for wire up to 5.0 mm Ø
30-5658 - 56cm
for wire up to 6.0 mm Ø





Wire Cutting Pliers

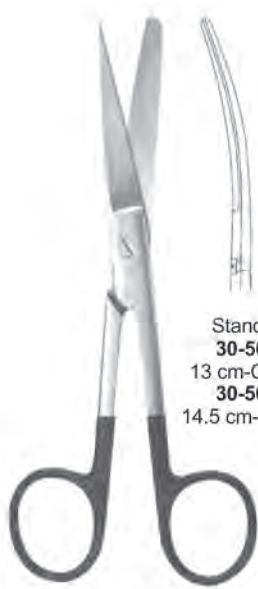

Standard
30-5661
13 cm-Curved
30-5662
14.5 cm-Curved

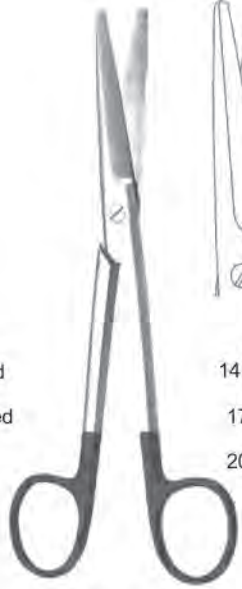

Mayo
30-5666
14.5 cm-Curved
30-5667
17 cm-Curved
30-5668
20 cm-Curved



Baby-Metzenbaum
30-5670
14.5 cm-Curved



30-5671
Straight

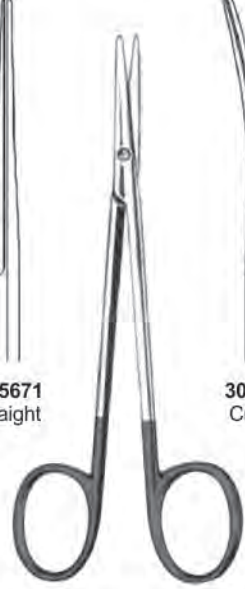

30-5672
Curved

Standard
30-5659
13 cm-Straight
30-5660
14.5 cm-Straight

Mayo
30-5663
14.5 cm-Straight
30-5664
17 cm-Straight
30-5665
20 cm-Straight

Baby-Metzenbaum
30-5669
14.5 cm-Straight

Strabismus
30-5671-30-5672
11.5 cm

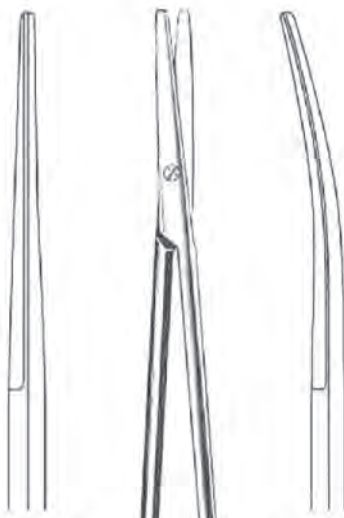

30-5673 - 18 cm
30-5674 - 20 cm
30-5675 - 23 cm



30-5676 - 18 cm
30-5677 - 20 cm
30-5678 - 23 cm

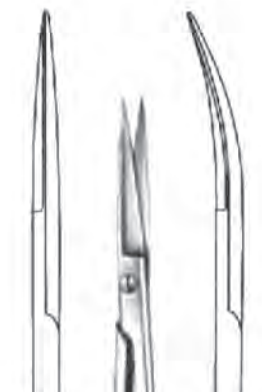

30-5679
Straight

30-5680
Curved



Westcott
30-5681-30-5682
11.5 cm



30-5681
Straight



30-5682
Curved

Metzenbaum-Nelson
30-5673 - 30-5678

Iris
30-5679-30-5680
11.5 cm





A

ABRAHAM	03	Bailey-Gibbon	88	Bone Shears	83
Abraham	112	Bainbridge	96	Bonney	19
Adson	185	Bakes	169	Bonney	235
Adson	187	Balfour	190	Bose	196
Adson	188	Balfour	191	Bose	197
Adson	19	Balfour	192	Bowman	199
Adson	235	Balfour-Baby	192	Bowman	201
Adson	27	Ball & Socket	33	Boynton	68
Adson	65	BALLENGER	113	Boys-Allis	158
Adson-Baby	27	Baracani	117	Bozemann	37
Adson-Brown	19	Barbara	127	Bozemann	66
Adson-Brown	235	Barraquer	199	Brand	49
Adults	200	Barraquer	203	Braun	215
Aebli	205	Barraquer	204	Braun	216
Aiach	141	Barraquer	22	Braun-Stadler	14
Alan-Parks	165	Barraquer	236	Breisky	211
Alderdyce	47	Barraquer	68	Breisky	221
Alexander	214	BARRON "B.P." type blades	04	Brophy	19
Alexander	42	Bauer	155	Brown	21
Alexander	46	Beckman-Adson	188	Brown	64
Allen	161	Beckman-Eaton	189	BRUENINGS	03
Allis	158	Beckmann	188	Bruenings	119
Allis-Adair	159	Bedpan Chamber Port Standard	229	Brünings	116
Allis-Baby	158	Bedpan Hand Made Standard	228	Brünings	111
Allison	88	Bedpan perfection type seamless	229	Brünings	115
Alm	184	Bedpan perfection type	229	Brünings	117
ALY	06	Bedpan Simple	229	Brünings	133
Anderson-Adson	185	Bedpan Sleeper Type	229	Brünings	147
ANDREW	146	Beebee	16	Brunner	83
Angle	243	Beer	22	Brunner	163
Applying Forceps	94	Bellucci	125	Brunner	180
Arruga	199	Bengolea	25	Brunner	71
Arruga	236	Bennett	48	Bruns	63
Arruga	68	Benson	161	Bruns	44
Arruga	68	Bergmann	63	Bryant	38
Arther	22	BERLINER	05	BUCK (Telescopic)	05
Asch	141	Bernhard Sharp	34	BUCK	05
Aston	15	BERTILLON Caliper	06	Buck	122
Aufricht	139	Bethune	83	Buck	128
Auward	211	Beyer	55	Buck	14
Ayer	203	Bickford	21	Buckley	184
Ayre	213	Billeau	128	Burford	85
		Bircher-Ganske	50	Burr Tray	227
		BIRKETT	115	Busch	14
		Bishop	146		
		Blake	215		
		Blake	169	C	
		Blohmke	114	Cairns (Dott)	21
		Blount	49	Canadian	21
		Blumenthal	54	Canfield	112
		Boerma	218	Carpenter	111
		Böhler	55	Carpenter	112
		Böhler	61	CARROLL	06
				CASPAR	81

B

Babcock	159	Bishop	146		
BABINSKY	05	Blake	215		
Baby-Babcock	159	Blake	169	Cairns (Dott)	21
Baby-Metzenbaum	244	Blohmke	114	Canadian	21
Backhaus Towel	33	Blount	49	Canfield	112
Backhaus with Clip	33	Blumenthal	54	Carpenter	111
Backhaus	33	Boerma	218	Carpenter	112
Bailey	88	Böhler	55	CARROLL	06
Bailey-Baby	88	Böhler	61	CASPAR	81



CASPAR	82	Collin-Landau	206	Dahlgren	76
Castañeda	110	Collyer	221	Dale	91
Castañeda	85	Colver	112	DANDY	13
CASTROVIEJO	03	COLVER	113	Dandy	23
CASTROVIEJO	06	Complete ENT set	07	Dandy-Mosquito	23
Castroviejo	200	Connin-Amsler	202	Dardik	91
Castroviejo	202	Converse	140	Dautrey-Munro	155
Castroviejo	205	Cooley	107	Davidson	180
Castroviejo	205	Cooley	108	Davis	223
Castroviejo	236	Cooley	109	Davis	73
Castroviejo	69	Cooley	84	Davis-Boyle	144
Castroviejo	69	Cooley-Derra	108	Day	111
Castroviejo	69	Cooper	72	Day	129
Castroviejo-barraquer	69	Cordes	117	De Bakey	101
Castroviejo-kalt	68	Corey	220	De Bakey	95
Cathetes Tray with Lid	227	Cottle (with side screw)	131	De Bakey	98
Catlin. Amputating Knives	02	Cottle	13	De Bakey	103
Cawood-Minnesota	146	Cottle	131	De Bakey	104
Champy	154	Cottle	132	De Bakey	105
Chaput	26	Cottle	137	De Bakey	106
Charnley	20	Cottle	138	De Bakey	109
Charrière	59	Cottle	139	De Bakey	234
Cheatle	223	Cottle	140	De Bakey	235
Cheron	37	Cottle	141	De Bakey	237
CHEVALIER-JACKSON	116	Cottle	230	De Bakey	87
Chevalier-Jackson	198	Cottle	41	De Bakey	93
Children	200	Cottle-Kazanjan	57	De Bakey	94
Children	200	Cottle-Walsham	141	De Bakey	97
Cinelli	12	Cotton Holder	225	De Bakey-Bahnson	103
Cinelli	137	Crafoord	12	De Bakey-Bahnson	102
Claus-Eicken	111	Crafoord	28	De Bakey-Beck	106
Cleveland	53	Crafoord-Sellors	28	De Bakey-Mosquito	104
Cleveland	57	Crile	109	De Bakey-Mosquito	90
Cloward	188	Crile	183	De Bakey-Pean	104
Cloward	76	Crile	27	De Bakey-Rankin	90
Colclough (Richter)	78	Crile	67	De Bakey-Satinsky	89
Colclough	77	Crile-Murray	65	De Martel	75
Colclough	78	Crile-Rankin	24	De Vilbiss	76
Collier	64	Crile-Wood	237	De Vilbiss	77
COLLIN Druck	06	Crile-Wood	65	Dean	13
COLLIN	04	Critchett	200	Dean	234
Collin	147	Cusco	206	Deaver	181
Collin	190	Cushing	174	DEAVER	10
Collin	206	Cushing	19	DeBakey	13
Collin	219	Cushing	235	DEJERINE	05
Collin	221	Cushing	75	De-lee	218
Collin	26	Cushing-Taylor	235	Delee	221
Collin	37	Czerny	165	Demel	61
Collin	41	Czerny	169	Denhart	142
Collin	71	Czerny	216	DENIS-BROWNE	114
Collin, Baby	190	D		Derf	236
Collin. Amputating Knives	02			Derf	64



Derra	106	Elliot	218	Fomon	14
Deschamps	70	Elsasser	167	Fomon	140
Deschamps	71	Elsching	201	Fomon	140
Desjardins	168	EMMET	21	Fomon	230
Desjardins	169	Emmet	38	Forceps Jar	225
Desjardins	29	Emmett	213	FOREGGER	09
Desmarres	174	Endodontic Box	225	Forster	37
Desmarres	175	ENGL. MODELL	33	FOWLER	03
Desmarres	201	Enterotomy Scissors	16	Fox	194
Desmarres	203	Enucleation Scissors	16	Fraenkel	117
DIEFFENBACH	01	Epker	156	FRANCKE	117
Dieffenbach	01	Epker-Bauer	155	Frazier	73
Diethrich	90	Esmarch	62	Freer	140
Diethrich	17	Esmarch	63	French	120
Dingmann	145	Eves	115	FRENZEL	147
Dingmann	50	F		Friedmann	53
Dissecting Forcep	18	FAGER	74	Fritsch	179
Dissecting Forcep	18	Falk	111	Frosch	50
Dolwick	153	Farabeuf	182	Frykholm	56
Dolwick	154	Farabeuf	46	Fuller	126
Douch Can/Irrigator	229	Farabeuf	51	G	
Douglas	111	Farrel	39	Gallipot	226
Douglas	22	Farrell	40	Gauss	219
Doyen	11	Farrior	118	Gelpi	189
Doyen	147	Faure	31	Gemini	29
Doyen	160	Favaloro	17	Gerald	20
Doyen	192	Fehland	164	Gerald	235
Doyen	210	Feilchenfeld	22	Gerster	59
Doyen	211	Fennle	225	Gerster-Lowman	59
Doyen	213	Fergusson	170	Giertz-Stille	83
DOYEN	33	Fergusson	50	Gigli Wire Saw	75
Doyen	39	FERGUSSON-ACKLAND	142	Gigli	75
Doyen	46	Ferris Smith	20	Gill	201
Doyen-Baby	160	Ferris-Smith Kerrison	79	Gillesberger	195
Doyen-Baby	162	Ferris-Smith-Kerrison	136	Gillies	194
Doyen-Baby	163	Fiber Optic	09	Gillies	21
Dressing Jar	225	Finochietto	86	Gillies	235
Duehrssen	19	Finochietto (modif.)	85	Gillies	239
Dunhill	24	Finochietto	29	Gillies	67
Dunn-Dautrey	155	Finochietto	85	Glover	101
Duplay	215	Finochietto, Baby	84	Glover	105
Duplay	37	Finochietto, Baby	86	Glover	89
Duplex super lightweight	06	Finochietto, Infant	84	Glover	94
Dupy-Weiss	112	Finsen	184	Gluck	83
DURHAM	111	Finsen-Martin	184	Goelet	183
Duval	160	Fisch	127	Goldman-Fox	17
E		Fish	39	Goldmann-Fox	234
Eastman	208	Fisher	111	Goldsmith	130
Echlin	56	Fletcher (javerts)	38	Goldstein	199
Eckelt	148	Fomon	12	Good	17
Eiselsberg	15	Fomon	137	Gorney	233
Electric Sterilizer	228	Fomon	139	Gorney	15
Electric Sterilizer	228				



Gosset	172	Hartmann	53	Iris Scissors (str/cvd)	15
Gosset	191	Hartmann-Halle	130	IRIS-FINE	15
Gosset	192	Hartmann-Wullstein	122	Israel	178
Gosset-Baby	191	HARVEY	16	Itard	121
Graefe	201	Haslinger	113	Iterson	197
Graefe	176	Hayes	164	Ives-Fansler	165
Graefe	201	Heaney	237	J	
Graefe	21	Heaney	31	Jackson	197
Graig	132	Heaney	65	Jackson	208
Grave	207	HEATH	14	Jackson	21
Gray	168	Hegar	211	Jacobs	216
Green-armytage	219	Hegar	212	Jacobson	69
Gregory	90	Hegar	238	Jameson	17
Gregory	92	Hegar	65	Jamison	66
Gregory, soft	90	Hegar-Baumgartner	236	Jansen	122
Groningen	75	Hegar-Baumgartner	64	Jansen	128
Gross	128	Hegar-Vascular	238	Jansen	184
Gross-Maier	37	Heiss	27	Jansen	53
Gruber	118	Heister	142	Jatho	134
Grünwald (Jansen)	133	Henckel	134	Javid	92
Grünwald	122	Henke	112	Jefferson	20
GUEDEL-NEGUS	08	Henley	187	Jennings	145
Guthrie	176	Hennig	62	Jeter-Van Sickels	153
Guyon	167	Hepp-Scheidel	236	Jhons-Hopkins	30
Guyon	32	Heymann	13	Jobson-horne	39
Gwynee Evans Dissector	112	Heymann	133	Johns-hopkins	39
H		Heymann-Knight	134	JONES Sharp	33
Haase	35	Heywood-Smith	216	JOSEPH	01
Hackstock	60	Heywood-smith	220	Joseph	13
Haigh	86	HOEN	73	Joseph	139
Haitz	202	Hofer	113	Joseph	140
Hajek	136	Hofmeister	222	Joseph	140
Hajek	41	Hohmann	48	Joseph	231
Halle	45	Hohmann, mini	48	Judd-Allis	158
Halsey	237	Hoke	43	Judd-Masson	172
Halsey	64	Holth	202	Judd-Masson	192
Halsted-Mosquito	23	Hopkins	62	K	
Handte	174	HORSLEY	74	Kahre-Williger	46
Hank	212	House	127	Kallmorgen	210
Hargis	156	House-Dieter	126	Kalt	68
Harken	100	Huber	116	Kalt-arruga	68
Hartmann	130	Hunter	22	Kane	219
Hartmann	116	Hurd	111	Katsch	195
Hartmann	118	Hurd	112	Kaye	15
Hartmann	120	I		Kaye	15
Hartmann	121	INCISION SCISSOR	10	Kedar Nath Das	218
Hartmann	122	Inge	77	Keen	153
Hartmann	128	Instruments Box Perforated	228	Kelly	11
Hartmann	132	Instruments Box	227	Kelly	165
Hartmann	136	Instruments Tray without Lid	227	Kelly	178
Hartmann	146	Iowa	216	Kelly	216
Hartmann	23	Iris	244	Kelly	234
					24



Kelly	30	Lambert	203	Liston	57
Kelly-Rankin	24	Lambert-Kay	101	Liston. Amputating Knives	02
Kern	51	Lambotte	43	Liston-Key	58
Kevorkian	214	Lambotte-Mini	43	Littauer	122
Keyes	194	Lancaster	200	Littauer	132
Kick Bucket	226	LANDOLT	79	Littauer	14
Kidney Tray Shallow	226	Lane	162	Little	175
Kidney Tray	226	Lane	34	Locklin	16
Kielland	218	Lane	52	Locklin	234
Killian	131	Lanes	21	Lockwood	159
Killian	132	Lange	117	Logan	184
Kilner	12	Lange	140	Lorenz	63
Kilner	140	Langenbeck	127	Lorna	34
Kilner	194	Langenbeck	142	Lotion Bowl without spout	226
Kilner	236	Langenbeck	240	Loute	61
Kilner	66	Langenbeck	46	Love	113
Kilner-Doughty	143	Langenbeck	47	Love	74
Kirschner	193	Langenbeck	50	Lovelace	24
Kirschner	61	Langenbeck	59	Lovelace	89
Klapp	176	Langenbeck. Amputating Knives	02	Lubet-Barbon	134
Kleinert-Kutz	49	Langenbeck. Flap Knives	02	LUC	133
Knapp	201	Laryngeal mirrors	117	Lucae	120
Knapp	203	Laufe Divergent Outlet	219	Lucae	121
Knight	133	Laufe-piper	219	Lucae	128
Kocher (Ochsner)	25	Lawrence	30	Lucae	129
Kocher	161	Lebsche	83	Lucae	41
Kocher	173	Leech-wilkinson	220	Luer	183
Kocher	176	Lees	100	Luer	196
Kocher	177	Lees	101	Luer	197
Kocher	222	Legueu	172	Luer	198
Kocher	25	Legueu	173	Luer	54
Kocher-Fino	25	Leksell-Stille	56	Luer-Körte	169
KOLLE	117	Leland-Jones	96	Lukens	197
König	72	Lempert	129	Luniatschek	111
Körte	178	Lempert	53	Lynch	112
Krause	117	Lerche	21		
Krause	121	Leriche	24	M	
Krause	132	Lewin	35	M. G. Hospital	65
Krause-Voss	132	Lewis	139	Macphail	67
Kressner	141	Lexer	12	MAGILL	07
Kristeller	208	Lexer	231	Maingot Intestina	21
Kristeller	209	Lexer	232	Maltz	139
Kristeller	210	Lexer	42	Marquard	55
Kronecker	39	Lexer	43	Marschik	112
Kronecker	72	Lexer-Baby	12	Martel	26
Kuhnt	201	Lexer-Fino	12	Martin	62
		Lexer-Mini	42	Martin "Diamant"	61
		Lexer-Mini	43	Martin	121
Laborde	196	Lichtenberg	240	Martin	131
LaGrange	17	Lichtenberg	67	Martin	179
Lahey	175	Lister	63	Martin	189
Lahey	222	Lister	38	Martin	221
Lahey	29	Lister-Burch	200	Martin	238

L

V



Martin	38	Metz	150	Morris-De Bakey	102
Martin	58	Metzenbaum Baby	11	Morse	86
Martin-Alloy	121	Metzenbaum Fino	11	Morse-Favaloro	86
Martini	239	Metzenbaum	11	Mueller	200
Martin-Simplex	146	Metzenbaum	231	Murdock	200
Masson	238	Metzenbaum	65	MUSEUX	113
Masson-Luethy	66	Metzenbaum-Aquila	230	Museux	216
Mastin	222	Metzenbaum-Aquila-Fino	230	Mustarde	21
Mathieu	173	Metzenbaum-Fino	232	Myles	136
Mathieu	183	Metzenbaum-Fino	233	Myrtle Leaf Probe	39
Mathieu	240	Metzenbaum-Lahey	232		
Mathieu	67	Metzenbaum-Nelson	244	N	
Mathieu	68	Metzenbaum-Nelson	11	Nabatoff	40
Maunder	142	Metzenbaum-Thorek	231	Naegele	218
Mayfield	55	Metz-Lauer	150	Nager	111
Mayo	244	Metz-Lauer	151	Nager	113
MAYO	10	MEYER	36	Nail Splinting Scissors	15
Mayo	170	Meyerding	175	National Hospital	05
Mayo	22	MICHEL Rhinoscopic	117	Needle Case Rectangle	225
Mayo-Blake	169	Michel	72	Needle Case Round with Cover	225
Mayo-guyon	32	Micro-Adson	19	Needle Case Round	225
MAYO-HARRINGTON	10	Micro-Mosquito	23	Negus Knot Tier and Pusher	112
Mayo-Hegar	237	Microvascular	239	NEGUS	114
Mayo-Hegar	64	Mikro-Hegemann	17	Negus	30
Mayo-Hegar	65	Mikulicz	31	Neivert	141
Mayo-Lexer	232	Mikulicz-Baby	31	Neivert	64
Mayo-Lexer-Aquila	230	MILLER	08	Nelaton	39
Mayo-Noble	11	Miller-Colburn	47	Nelson	22
Mayo-Robson	160	Milligan	187	Nerve Dissecting Scissors	12
Mayo-Robson	163	Milligan	73	Neukam	143
MAYO-STILLE	10	Millin	171	NEUMANN	16
Mayo-Stille	231	Millin	172	Neuro	121
McDonald	47	Mini-Adson	19	Nissen	168
McGee	125	Mini-McGee	123	Non Electric Sterilizer	228
MCINDOE	13	Mini-McGee	124	Northbent	15
McIndoe	20	Mirror handle	117	Nott	207
McIndoe	235	Mixer O'Shaugnessy	29	Noyes	134
McINTOSH	09	Mixer	29	Noyes	204
McIvor	144	Mixer-Baby	27		
McKenzie	76	Mod. Hamburg	201	O	
McPherson	203	Mod. Wien	130	O'Connor	176
McQuigg-Mixer	30	Mod. USA	14	O'Sullivan-O'Connor	193
McWHOOPER-LOTHROP	114	Modell USA	44	Obwegeser	142
Mead	41	Moldenhauer	128	Obwegeser	146
Mead	53	Molison Pillar	112	Obwegeser	149
Measuring Jug	229	Mollison	115	Obwegeser	150
Medicine Cup	226	Mollison	186	Obwegeser	151
Medium battery	07	Molt	142	Obwegeser	152
Meeker	30	Molt	45	Ochsner	18
Mellinger-Axenfeld	200	MOLTGEN	06	Ochsner	90
Meryer	36	Moncorps	194	Oehler	235
Metal handle	02	Moore	170	Officer	21



Schamberg	195	Simon	45	Strandell-Stille	176
Schede	44	Simpson	218	Stratte	239
Scheibe	162	Simpson-braun	218	Stratte	66
Scheinmann	117	Sims (single ended)	208	Strully	13
SCHINK	03	Sims	11	Struycken	135
Schmedenschmeden	136	Sims	165	Subramanian-Miniature	110
Schmieden	72	Sims	208	Swivelhead	04
Schmieden-Dick	72	Sims	217	SYME	39
Schmieden-Payr	72	Sims	233		
Schnidt	114	Sims-Aquila	233	T	
Schnidt	27	Sims-Siebold	11	Tabb	127
SCHOEMAKER	222	Singley-Tuttle	22	TAYLOR	05
SCHOEMAKER-LOTH	14	Smith	156	Taylor	20
Schoenberg with safety guard	34	Smith-Petersen	43	Taylor	49
Schoenberg	34	Smithwick	75	Teale	216
Schröder	215	Spackmann	220	Terrier	23
Schröder	215	Spare bulb	07	Terry	157
Schuchardt	150	Spare mirrors only	117	THILENIUS	114
Schuchardt-Lauer	150	Speaking Tubes	198	Thoms-Allis	158
Schuchardt-Lauer	151	Spencer	14	Thomson-Walker	173
Schuknecht	127	Spencer-Wells	24	Thorek	12
Schumacher	117	Spong Bowl	226	Tieck-Halle	131
Schumacher	214	Sprit Lamp	225	Tissue Forcep	18
Schwarz	130	Sputum Cup	225	TIVNEN-TYDING	113
Scudder	163	ST Mark	21	Tobold	146
Sedillot	46	ST. Clair Thomson	130	Toennis	240
Segond	213	Stacke	39	Toennis	67
Seiffert	117	Standard	244	Toennis	74
Sellheim	219	STANDARD	04	TOENNIS	13
Sellors	88	STANDARD	10	Toennis-Adson	13
Semb	46	Steinhäuser	35	Toennis-Adson	232
Semb	51	Steinhäuser	157	Tohoku (Blunt)	33
Semb	55	Steinmann	49	Tönnis-Adson-Aquila	230
Semb	89	Stellbrink	53	Took	201
Semken	20	Sterilizer Drum	228	TOWNLEY	06
Semken	235	Sternberg	146	Toynbee	118
Semm	193	Stevens	16	Traction Cable	40
Semm	207	Stevens	68	Trelat	207
Senn-Green	175	Stieglitz	22	Treves Block end	18
Senn-Miller	174	Stille	63	Treves Turn over	18
Seyffert	207	Stille	18	Trigeminal Knife	03
Shaaf	22	Stille	42	Troeltsch	118
Shapleigh	127	Stille	55	Troeltsch	121
Sharp	33	Stille-Liston	57	TROEMNER	05
Sheehan	137	Stille-Liston	58	Tröltsch	122
Sichel	201	Stille-Luer	56	Tröltsch	133
Siegle	119	Stille-Martin	63	Trousseau	196
Silcock	21	Stille-Ruskin	56	Troutman-Barraquer	205
SILVER	03	Stomach, Intestines, Rectum	241	TROUTMAN-CHRIS	03
Silver	39	Stone	21	Tubbs	109
Simon	179	Stone-Watt	162	Tube Rack	225
Simon	213	Strabismus	244	Tubinger Model	179
Simon	215	Strabismus Scissors	16	Tuebingen	203



Tuffier	26	Watson-Williams	135	Wullstein	127
Tuffier	86	Waugh	19	Y	
Tunneling Forceps	38	Weber	201		
Turnbull	224	Weber	99	Yankauer	112
Tyding	116	Weber-Loch	128	Yankauer	132
Tydins	112	Webster	236	YASARGIL	79
U		Webster	64	Young	147
Uckermann	196	Wecker	204	Young	170
Ulrich	37	Weerden	196	Z	
Ulrich	52	Weil	135	Zaufal	128
Universal	63	Weil-Blakesley	135	Zaufal-Jansen	55
Universal	16	Weiss	199	Zenker	29
Universal	234	Weiss	200	Ziegler	201
Unna	194	Weitlaner	185	Zigler	201
Unna	195	Weitlaner	185		
Unna-Vidal	195	Weitlaner-Baby	187		
Urinal Female Standard	229	Weitlaner-Wullstein	186		
Urinal Male Standard	229	Wertheim	12		
Urinal Male Vertical Standard	229	Wertheim	31		
Uro-Tangential	32	Wertheim	66		
USA Mode	18	Wertheim-Cullen	32		
V		West	202		
Vacher	130	Westcott	244		
Vannas	204	Westmacott	134		
Varady	40	White	113		
Veidenheimer	164	Wieder	146		
Verbrugge	52	Wigmore	62		
VERNIER Universal	06	Wikstroem	30		
Vickers	58	Wilder	202		
Vidal	194	Willet	220		
Vienna	130	Williams	159		
Volkman	177	Williger	41		
Volkman	44	Williger	41		
Volkman	44	Williger	45		
Volkman	44	Williger	46		
Volkman	44	Williger	46		
Volkman	45	Williger	47		
Voltolini	130	WILSON	115		
W		Winter	220		
Wachenfeldt	72	Winter-nassauer	220		
Wagener	129	Wire Mesh Tray with Lid	227		
Wagner	17	Wire Mesh Tray	227		
Waldmann	14	with wooden handle	02		
Wallich	221	Wittner	214		
Walter	138	Woakes	121		
Walton	58	Wolff	62		
Wangensteen	19	Wolff	194		
Wangensteen	66	Wolford	153		
WARTENBERG	06	wooden handle	02		
Wash Basin	226	WOODSON	73		
Wassmund	178	WOODSON	74		
		Wrigley	218		
		Wullstein	125		



Muhammad Fazal Elahi

This house owes its birth and worldwide confidence and guidance of Mian Muhammad Fazal Elahi. Born in 1890. He was retired from M.F.Elahi & Co (E.P) PVT LTD after sixty years of dedicated services to the cause of human health and welfare along his sons and later on grandsons. He was died in 1975.

Abdul Hameed

He was born in 1917 and elder son of Mian Haji Muhammad Fazal Elahi. He starts working and exports in 1937 with his father and then along with his younger brother globally in M.F.Elahi & Co PVT LTD. He died at a young age of 27 years in 1944 at the time of sub-continent.

Jahangir Iqbal

He was born 1943 and starts working in 1963 . He worked as production executive in M.F.Elahi & Co (E.P) PVT LTD for 39 years.

After the separation and dissolution of M.F.Elahi & Co (E.P) PVT LTD , he re-establish the company Name with M.F.Elahi Medical Co. in 2002.

With his abilities and capabilities. he serve the surgical industry for 54 years.

He was previously managing partner in the company. He was died at the age of 73years in 2016.



M.F.ELAHI MEDICAL CO

SERVING WORLDWIDE SURGICAL INSTRUMENTS



Near Round About Factory Area
(S.I.E.) Sialkot 51310 Pakistan.



+92 52 3253144



+92 333 8384444



+92 52 3253544



export@mfelahi.com



www.mfelahi.com